

Sospensioni, Lampade da soffitto, Lampade da parete,  
Lampade da tavolo, Lampade da terra, Sistemi, Proiettori  
e Binari, Lampade da incasso, Lampade da esterno.  
**Selezione per designer e architetti.**

**Light is about moments.**



ideal lux. selection

**Ideal Lux s.r.l.**

**Headquarter**

Via Taglio Destro, 32  
30035 Mirano — Venezia  
P.I. / C.F. 02420040277  
8.00 - 12.00 / 13.30 - 17.30

**Warehouse**

Via delle Industrie, 8/D  
30036 Santa Maria di Sala — Venezia  
8.00 - 12.00 / 13.00 - 17.00

E [info@ideal-lux.com](mailto:info@ideal-lux.com)

T +39 041 5790500

F +39 041 8872349

Ig: [ideal.lux](#)

Fb: [Ideal Lux](#)

[www.ideal-lux.com](http://www.ideal-lux.com)

Copyright 2024 © IDEAL LUX S.r.l.

All rights reserved

Tutti i diritti sono riservati

Questo catalogo è una selezione dei nostri prodotti pensata per designer, architetti e professionisti dell'illuminazione.

È stata ideata come risorsa per guidarvi nel percorso creativo, offrendo ispirazione e strumenti per individuare rapidamente le opzioni più adatte alle vostre visioni.

La nostra esperienza nel bilanciare forma e funzione si riflette su ogni prodotto proponendo soluzioni di illuminazione che parlano sia all'estetica contemporanea che alla funzionalità senza tempo.

Il team di Ideal Lux è pronto ad accompagnarvi in questo viaggio.

Raffaele Strano, CEO

A handwritten signature in black ink, appearing to read 'Raffaele Strano', written in a cursive style.

La luce offre accoglienza, riparo, calore, raccoglimento, intimità. Viene celebrata da Ideal Lux attraverso i suoi prodotti, lampade d'arredo essenziali. La sfida che ogni giorno si impegna a vincere è quella di unire il design dei prodotti e l'immaterialità della luce per creare spazi personalizzati e unici, in grado di raccontare la storia di chi li anima.

Chiunque lavori nell'ideazione degli spazi da vivere può trovare in Ideal Lux il partner ideale per definire aree capaci di raccontare le vite dei propri clienti, creando contesti in cui ognuno diventa il protagonista della propria storia. Ambienti che rappresentano al meglio la personalità e il gusto di chi li abita.

La luce è una forma di energia pura che crea gioia e che non solo ci permette di vedere, ma influenza il nostro umore e benessere.

L'attenzione per le persone è centrale, ed è per questo motivo che ogni sistema di illuminazione è pensato per valorizzare ogni istante e ogni luogo, al fine di dare l'opportunità di esprimere al meglio ciò che è importante per ognuno di noi.

Adesso la luce non è più solo funzionale a illuminare un ambiente, ma lo nobilita, esprimendo appieno l'essenza che il progettista ha voluto imprimere attraverso geometrie e materiali.

---

**Ogni spazio, se illuminato con la luce giusta, assume un significato più profondo, autentico e vitale, raccontando i diversi momenti del nostro quotidiano.**

---



LIGHT IS

ABOUT MOMENTS

Dal 1974, Ideal Lux si dedica con passione alla realizzazione di complementi d'arredo illuminotecnici in grado di soddisfare ogni tipo di necessità. La collezione *Selection* raccoglie alcuni tra i più di 3700 prodotti offerti dall'azienda, pensata per abbracciare un gusto moderno e orientato al design.

## LIGHT TALES

SIA LA LUCE  
CHE I MOMENTI  
POSSONO ESSERE  
FUGACI.  
LA LUCE  
CHE SCOMPARE  
SPEGNENDO  
L'INTERRUTTORE,  
I MOMENTI  
CHE PASSANO  
IN UN BATTER  
D'OCCHIO.  
TUTTO QUESTO  
LI RENDE  
INDIMENTICABILI.



L'attenzione e la dedizione al cliente sono il fondamento stesso di Ideal Lux. Il nostro Customer Care costituisce un pilastro fondamentale all'interno dell'azienda, con un'enfasi sull'affidabilità come nostro valore cardine. Poniamo le esigenze delle persone al vertice delle nostre priorità.

---

**Per noi la qualità non può esistere senza garanzia. Abbiamo ampliato la copertura a 5 anni su tutti i nostri complementi illuminotecnici, per assicurare sempre gli standard più elevati nei prodotti e nei servizi offerti.**

---





LAMPADIE DA PARETE  
P. 142

## INDICE SEZIONI

SCHEDA TECNICHE  
P. 481



LAMPADIE DA TAVOLO  
P. 198

LAMPADE DA SOFFITTO  
P. 112



SOSPENSIONI  
P. 14



LAMPADE DA TERRA  
P. 226



## INDICE SEZIONI

SCHEDE TECNICHE  
P. 481



LAMPADE DA INCASSO  
P. 340



PROIETTORI E BINARI  
P. 270



SISTEMI  
P. 270



LAMPADE DA ESTERNO  
P. 368

# INDICE ALFABETICO

INTERNI → IN  
ESTERNI → OUT

**AGOS** OUT  
→ Da terra 370

**ANDROMEDA** OUT  
→ Da parete 378

**ATOM** OUT  
→ Da parete 382

**BEAN** IN  
→ Da parete 144

**BINOMIO** IN  
→ Da parete 148  
→ Da soffitto 488

**BIRDS** IN  
→ Sospensione 489  
→ Da soffitto 114  
→ Da parete 490  
→ Da tavolo 490  
→ Da terra 228

**CLIP** IN  
→ Da parete 152

**COVER** IN  
→ Da parete 156

**DELTA** IN  
→ Da parete 162

**DEVA** IN  
→ Sistema 272

**DIESIS** IN  
→ Sospensione 493  
→ Da tavolo 493  
→ Da terra 234

**DISPLAY** IN  
→ Proiettore 278

**DORSALE** IN  
→ Da terra 242

**DYNAMITE** IN  
→ Sospensione 495  
→ Da soffitto 118

**EGO** IN  
→ Da terra 495  
→ Sistema 286

**EOS** IN  
→ Proiettore 306

**EQUINOXE** IN  
→ Sospensione 16  
→ Da parete 498  
→ Da terra 248

**ESSENCE** IN  
→ Sospensione 498  
→ Da parete 168

**FILO** IN  
→ Sospensione 20  
→ Da parete 500  
→ Da tavolo 501  
→ Da terra 254

**FLUO** IN  
→ Sistema 314

**FLY** IN  
→ Da soffitto 124

**FOCUS** IN  
→ Da parete 174

**FOX** IN  
→ Proiettore 320

**FRAME** IN  
→ Sospensione 24  
→ Da soffitto 130  
→ Da terra 507

**FUTURA** IN  
→ Da tavolo 200  
→ Da terra 508

**GAME** IN  
→ Da incasso 342

**GEMINI** IN  
→ Sospensione 32  
→ Da soffitto 509

**GUN** OUT  
→ Da soffitto 611  
→ Da parete 388

**JEDI** OUT  
→ Da terra 396

**LIKA** IN  
→ Da incasso 348

**LINK** IN  
→ Binario 588

**LINEA** OUT  
→ Da parete 402

**LINUS** IN  
→ Sistema 324  
→ Da parete 600

**LOLITA** OUT  
→ Da tavolo 406

**LOOK** IN  
→ Sospensione 38  
→ Da soffitto 511  
→ Da parete 511  
→ Da terra 511  
→ Per binari 512

<b>MAPA</b>	IN	<b>PERLAGE</b>	IN	<b>STARLIGHT</b>	OUT
→ Sospensione	46	→ Sospensione	94	→ Proiettore	436
→ Da soffitto	514	→ Da soffitto	526		
→ Da parete	513	→ Da parete	527	<b>STYLE</b>	OUT
→ Da tavolo	206	→ Da tavolo	527	→ Da parete	618
		→ Da terra	260	→ Da terra	442
<b>MINT</b>	IN	<b>PIANO</b>	IN	<b>SWIPE</b>	OUT
→ Sospensione	52	→ Da parete	184	→ Da parete	448
<b>MIX UP</b>	IN	<b>PUNTO</b>	OUT	<b>TAURUS</b>	OUT
→ Sospensione	56	→ Da parete	414	→ Da incasso	454
→ Da soffitto	515			<b>TECHO</b>	OUT
→ Da terra	516	<b>PURE</b>	OUT	→ Da soffitto	460
<b>MOBY</b>	IN	→ Da terra	418	<b>TESI</b>	IN
→ Sospensione	68	→ Da tavolo	614	→ Sistema	336
<b>NEMO</b>	IN	<b>QUICK</b>	IN	<b>TESLA</b>	OUT
→ Sospensione	74	→ Proiettore	330	→ Da terra	466
<b>NINFEA</b>	IN	<b>SET UP</b>	IN	<b>ULTRATHIN</b>	IN
→ Da soffitto	518	→ Sospensione	528	→ Sospensione	106
→ Da parete	178	→ Da soffitto	528	<b>VEGA</b>	OUT
→ Da tavolo	518	→ Da parete	188	→ Da terra	472
<b>NITRO</b>	IN	→ Da tavolo	220	<b>VIRUS</b>	IN
→ Da soffitto	134	→ Da terra	266	→ Da incasso	358
<b>NOVA</b>	IN	<b>SIRIO</b>	OUT	<b>ZEUS</b>	IN
→ Da incasso	352	→ Da parete	615	→ Da incasso	362
<b>ORACLE SLIM</b>	IN	→ Da terra	422	<b>ZIG ZAG</b>	IN
→ Sospensione	80	→ Proiettore	615	→ Da parete	192
→ Da soffitto	523	<b>SMARTIES</b>	IN		
<b>OZ</b>	IN	→ Sospensione	100		
→ Sospensione	88	→ Da soffitto	532		
→ Da soffitto	524	→ Da parete	533		
→ Da parete	525	→ Da tavolo	533		
→ Da tavolo	212	<b>SOLE</b>	OUT		
		→ Sospensione	615		
		→ Da terra	430		
		<b>SPIKE</b>	IN		
		→ Da soffitto	138		
		→ Proiettore	604		

## SOSPENSIONI

SGUARDO  
AMOREVOLE,  
TERRA UMIDA,  
MANI SAPIENTI,  
ACQUA FRESCA,  
FOGLIE  
CHE BRILLANO,  
LUCE  
CHE VIBRA,  
LAMPADA  
ACCESA,  
GOCCE  
CHE CADONO,  
PIANTE  
RIGOGLIOSE.







Indice

↳

16	<b>Equinoxe</b>
20	<b>Filo</b>
24	<b>Frame</b>
32	<b>Gemini</b>
38	<b>Look</b>
46	<b>Mapa</b>
52	<b>Mint</b>
56	<b>Mix Up</b>
68	<b>Moby</b>
74	<b>Nemo</b>
80	<b>Oracle Slim</b>
88	<b>Oz</b>
94	<b>Perlage</b>
100	<b>Smarties</b>
106	<b>Ultrathin</b>

SOLO SCHEDE TECNICHE	489	Birds
	493	Diesis
	495	Dynamite
	498	Essence
	528	Set Up



## EQUINOXE

Montatura in metallo placcato.  
Diffusori in vetro borosilicato  
trasparente. Cavo in pvc nero.  
Colori: montatura cromo con  
vetro trasparente o fumè sfumato,  
montatura ottone antico con vetro  
trasparente o ambra sfumato.

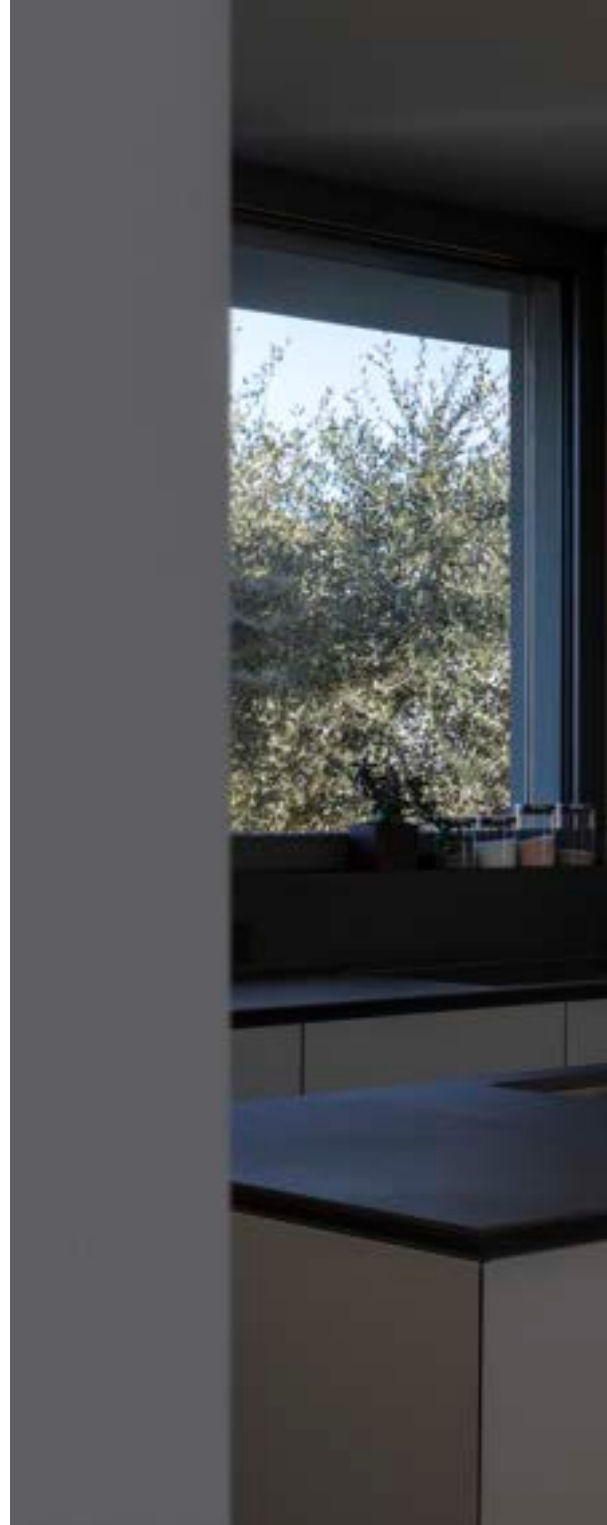









## FILO

Rosone e corpi luci in metallo verniciato a polveri o placcato. Cavi elettrici in pvc nero. Modelli 300801, 300818 e 300825 con 4 metri di cavo e interruttore sul rosone. Colori: bianco, nero oppure ottone satinato.













## FRAME

Base e montatura in metallo verniciato bianco opaco o nero opaco. Diffusori in materiale plastico colore opale. Cavi regolabili in lunghezza. Emissione luce diretta.



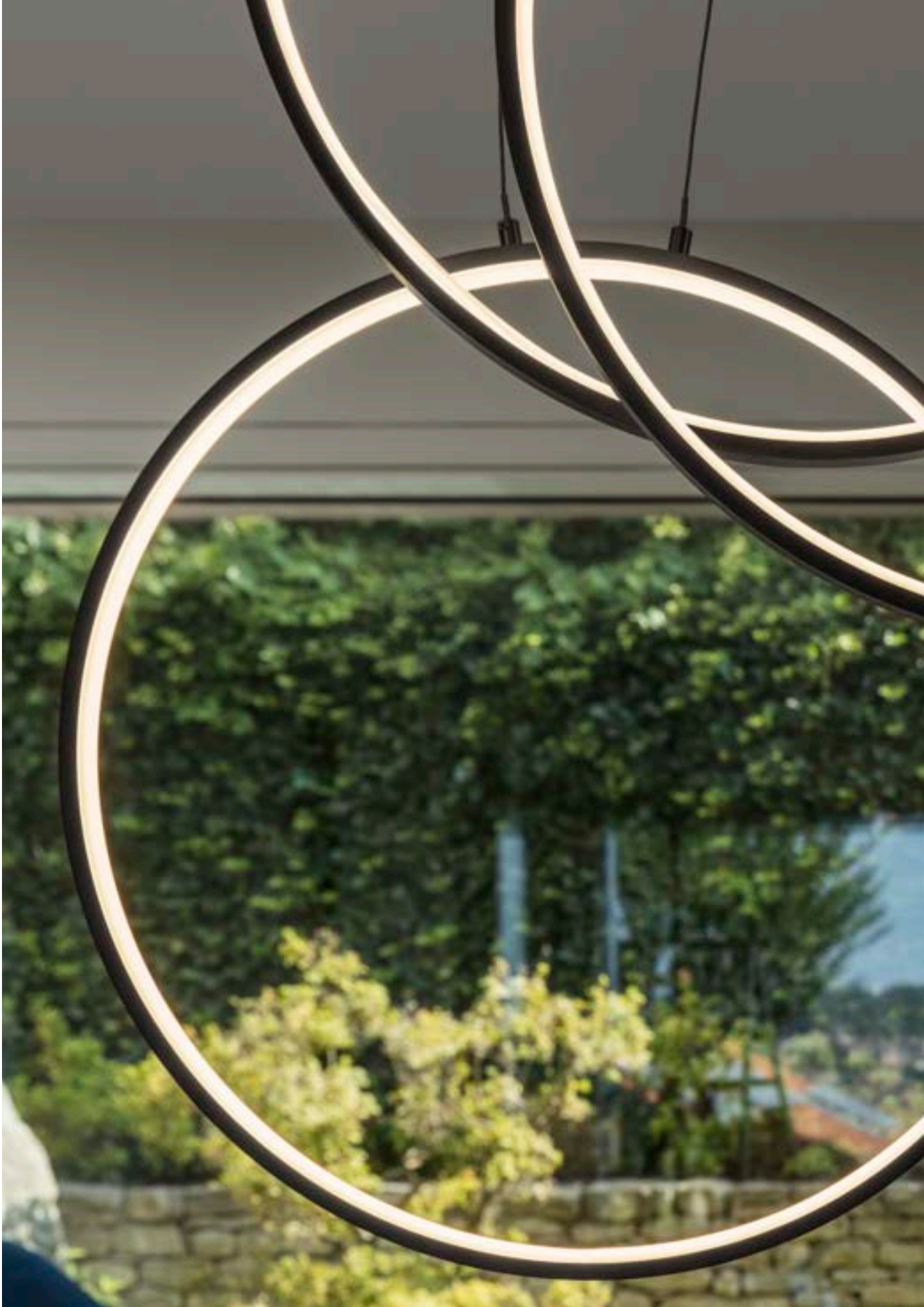















## GEMINI

Rosone e paralume in metallo verniciato a polveri o placcato. Diffusore in policarbonato opale. Cavo in pvc trasparente. Disponibile nelle finiture bianco, nero o ottone spazzolato. Modelli con diametro 810 mm e 610 mm disponibili anche in versione dimmerabile DALI/Push.













## LOOK

Rosone e diffusore in metallo con varie finiture. Cavo in tessuto regolabile in lunghezza. Monta lampadine sostituibili. Modello con finitura cromo sfumato con diffusore in vetro.





















## MAPA

Montatura in metallo bianco.  
Diffusore a sfera in vetro bianco  
soffiato e acidato. Cavi in acciaio  
a lunghezza regolabile.







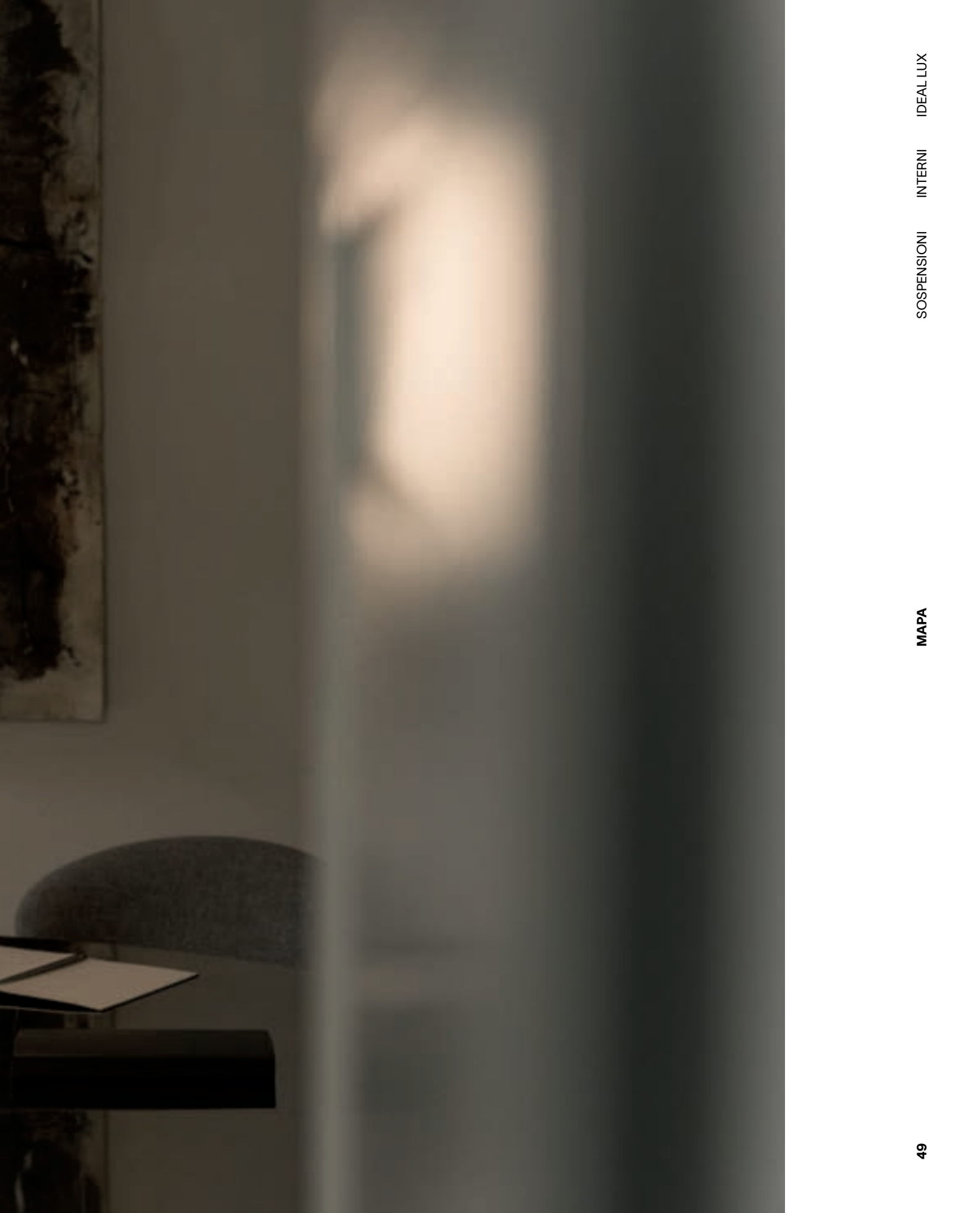



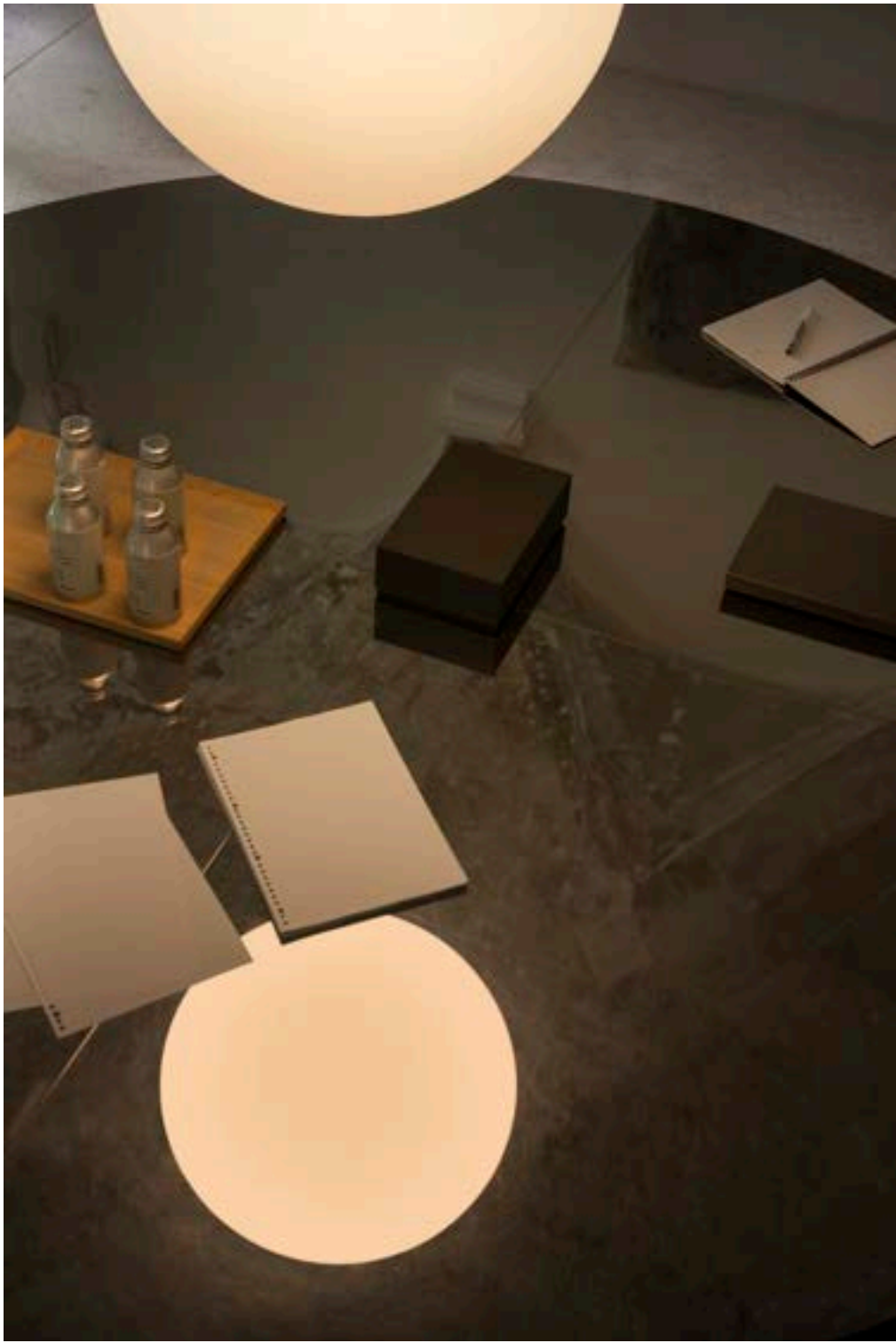



## MINT

Montatura in metallo con finitura  
ottone satinato e rosone nero  
opaco. Cavo rivestito in tessuto.  
Diffusore in vetro soffiato con  
rigatura in rilievo. Disponibile  
nelle finiture fumè o verde.











## MIX UP

Rosone e paralumi intercambiabili  
in metallo verniciato a polveri.  
Cavo in PVC. Finiture: bianco  
oppure nero.

























IDEAL LUX

INTERNI

SOSPENSIONI

MIX UP



## MOBY

Montatura e diffusore in metallo con interno bianco. Disponibile nelle finiture bianco, nero o rame.











IDEAL LUX

INTERNI

SOSPENSIONI

MOBY







## NEMO

Diffusore in vetro soffiato. Disponibile in versione fumé, rame, ambra, trasparente o cromo sfumato.



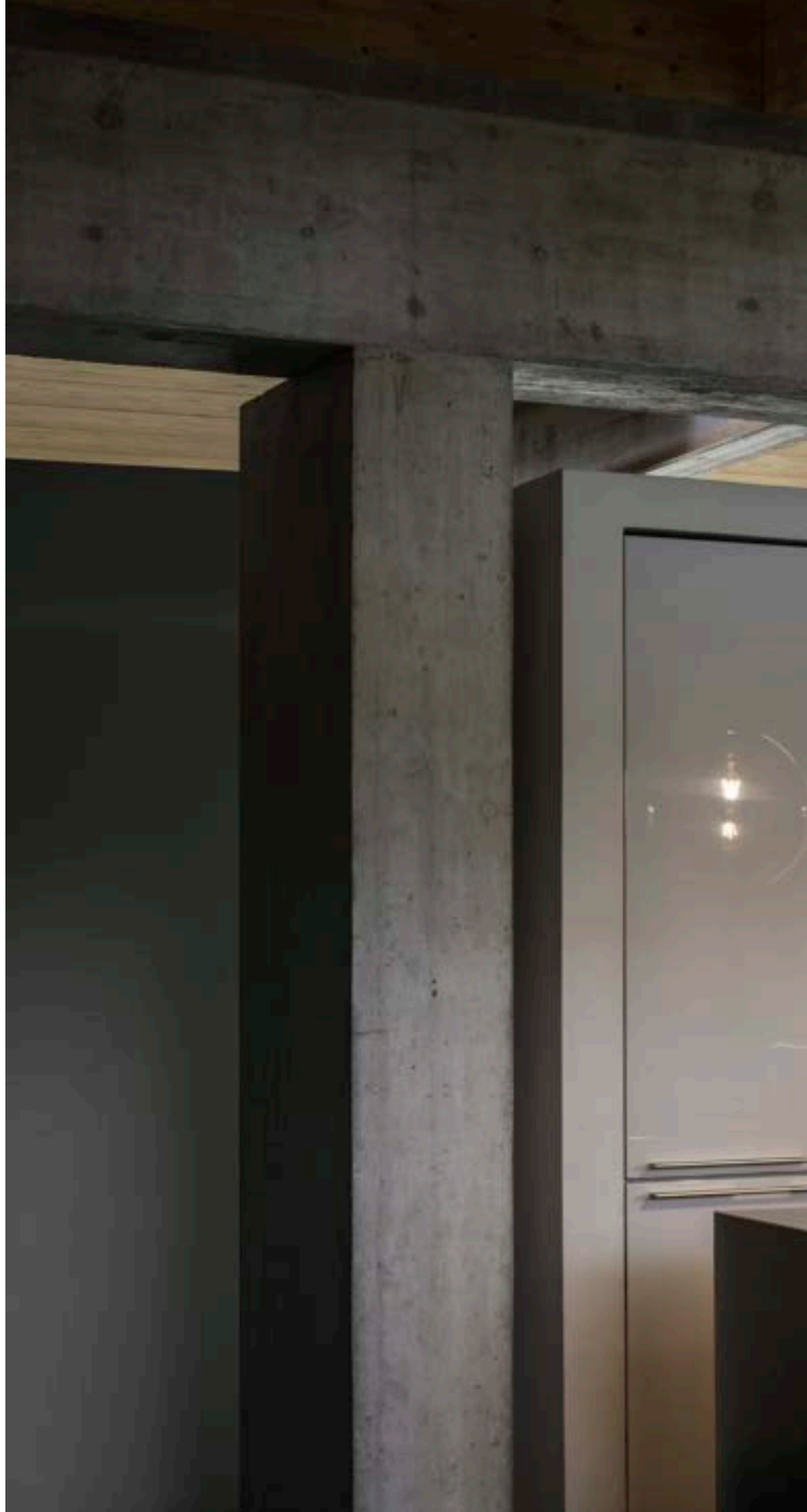











## ORACLE SLIM

Lampada a sospensione costituita da una montatura sottile in alluminio verniciato bianco o nero opaco e diffusore opale in policarbonato. Disponibile in versione round (quattro dimensioni) e versione square (tre dimensioni).





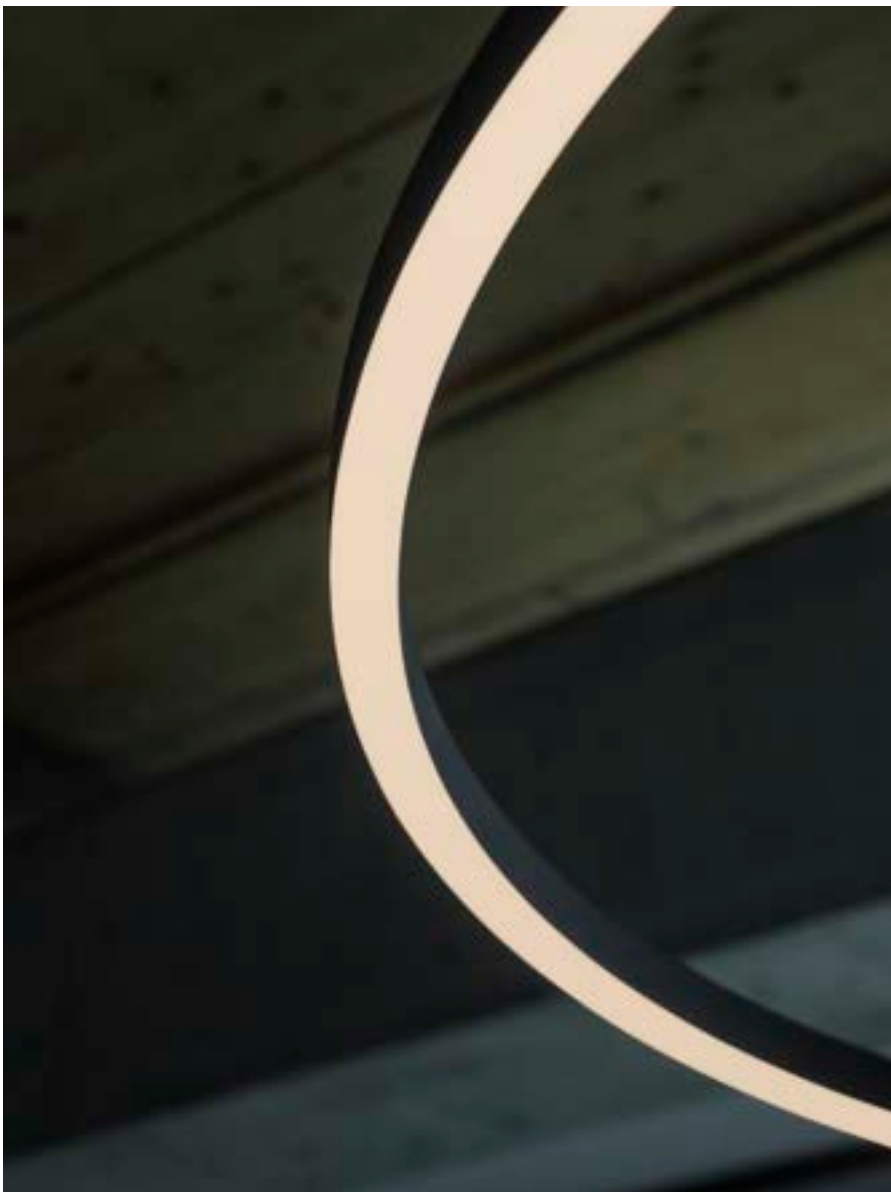





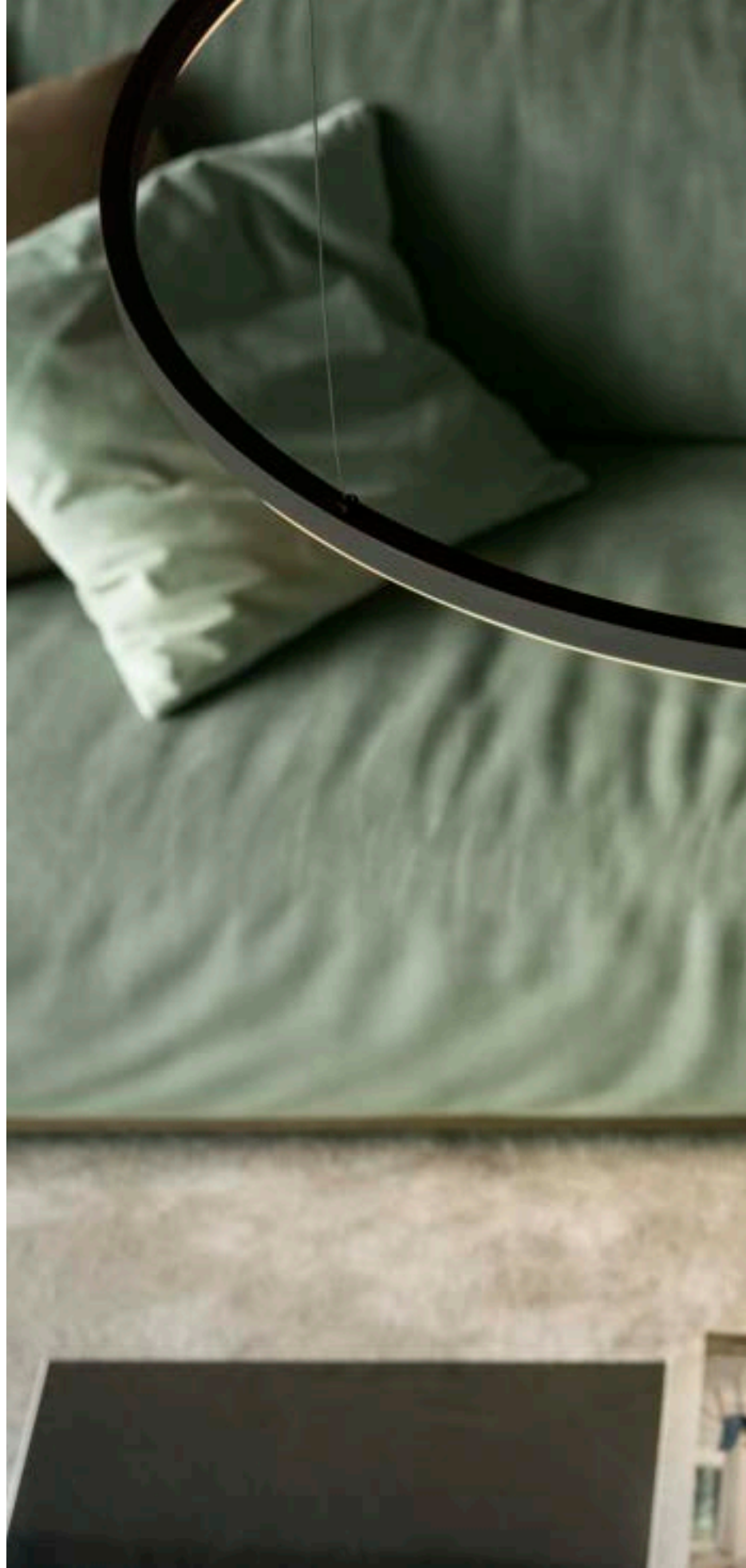





# OZ



Base e montatura in metallo verniciato a polveri o placcato. Cavi in pvc. Diffusore in gomma opale. Finiture: bianco, nero o ottone spazzolato. Disponibile anche in versione dimmerabile DALI/Push.







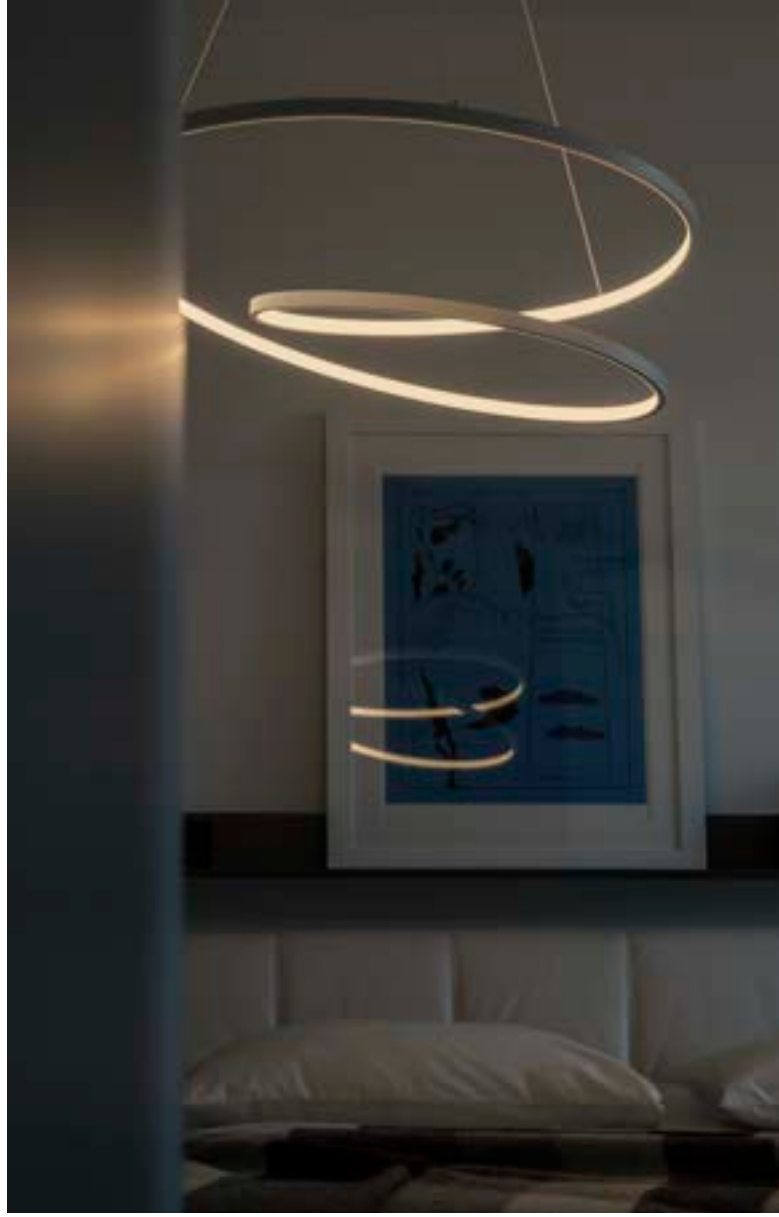





## PERLAGE

Montatura in metallo con truttura lineare a sezione tonda o con struttura circolare a sezione quadrata. Diffusori in vetro soffiato. Cavo elettrico in pvc. Colori: montatura nero opaco con vetri fumè, montatura ottone satinato con vetri bianchi acidati o montatura ottone satinato con vetri ambra.















## SMARTIES

Montatura in metallo verniciato bianco. Diffusore in vetro bianco soffiato. Cavi in acciaio a lunghezza regolabile con dispositivi ferma cavo automatici.

















## ULTRATHIN

Rosone e corpo luce in metallo verniciato opaco o placcato. Cavo in tessuto. Colori: bianco, cromo, ottone spazzolato o nero.









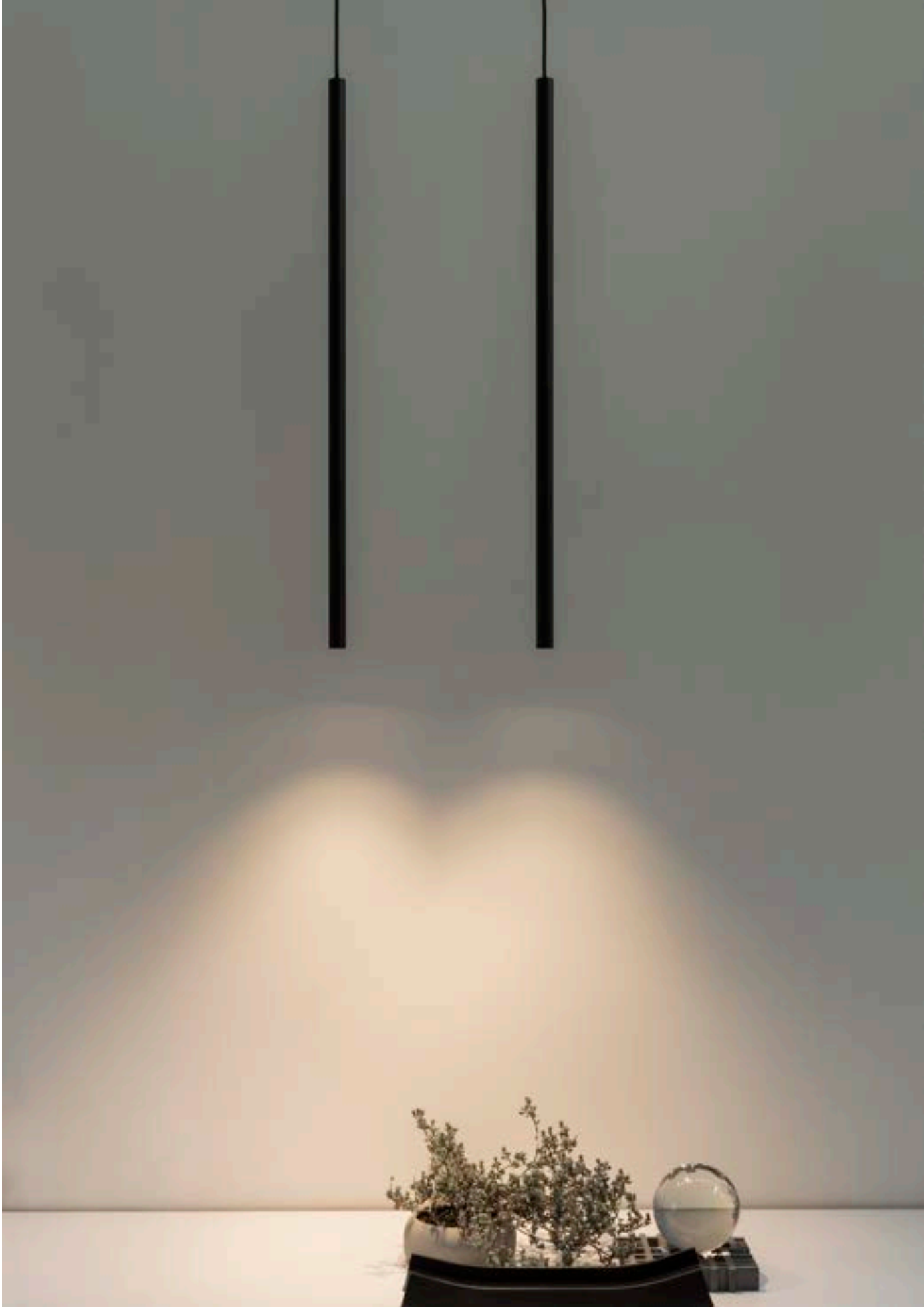





## LAMPADE DA SOFFITTO

BAMBINI  
CHE RIDONO,  
CUCINA  
IN SUBBUGLIO,  
MANI  
IMPASTATE,  
SORRISI  
SODDISFATTI,  
DOLCE  
PROFUMATO,  
LAMPADE  
ACCESE,  
OMBRE  
CHE BALLANO,  
RICORDI  
CHE SI FISSANO.





Indice

↳

114 **Birds**  
 118 **Dynamite**  
 124 **Fly**  
 130 **Frame**  
 134 **Nitro**  
 138 **Spike**

SOLO SCHEDE TECNICHE

509 Gemini  
 511 Look  
 514 Mapa  
 515 Mix Up  
 518 Ninfea  
 523 Oracle Slim  
 524 Oz  
 526 Perlage  
 528 Set Up  
 532 Smarties



## BIRDS

Montatura in metallo verniciato con disco decorativo in ottone satinato. Diffusori in vetro soffiato bianco acidato. Colore: nero opaco con dettaglio ottone satinato.







## DYNAMITE

Montatura in metallo rifinito  
con vernice a polveri o placcato  
e spazzolato. Diffusori orientabili.















## FLY

Famiglia di lampade a plafone con base circolare, disponibile in quattro diametri diversi (350 mm, 450 mm, 600 mm, 900 mm) oltre che nella variante SLIM dall'altezza più compatta. Corpo luce in alluminio verniciato a polveri in finitura bianco RAL 9016 e nero RAL 9004, ottica arretrata (FLY PL) oppure a filo (FLY SLIM) con diffusore in PMMA microprismatizzato con controllo dell'abbagliamento (UGR < 19). La lampada è predisposta per essere integrata con il modulo accessorio uplight per la componente di illuminazione indiretta.



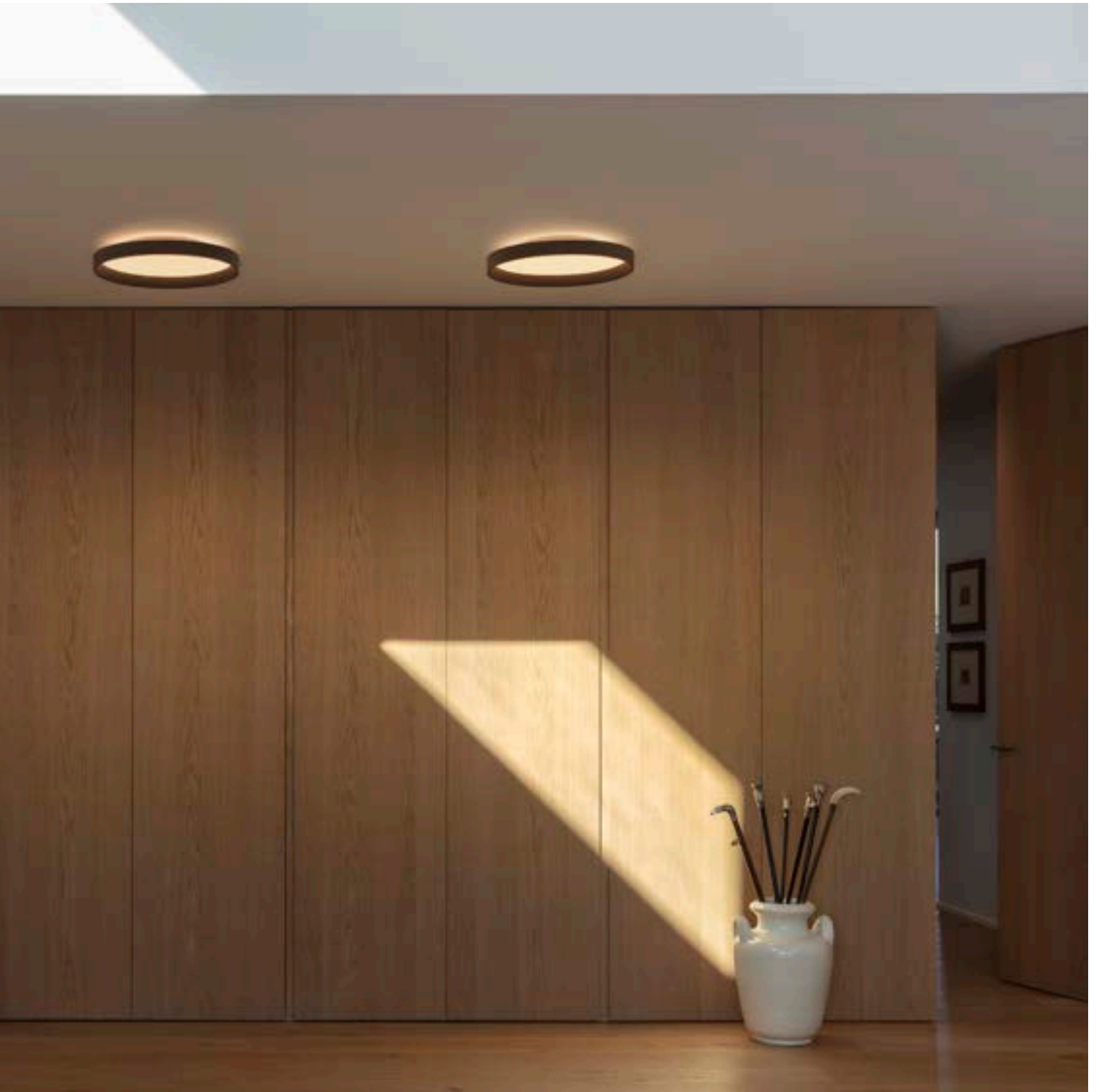





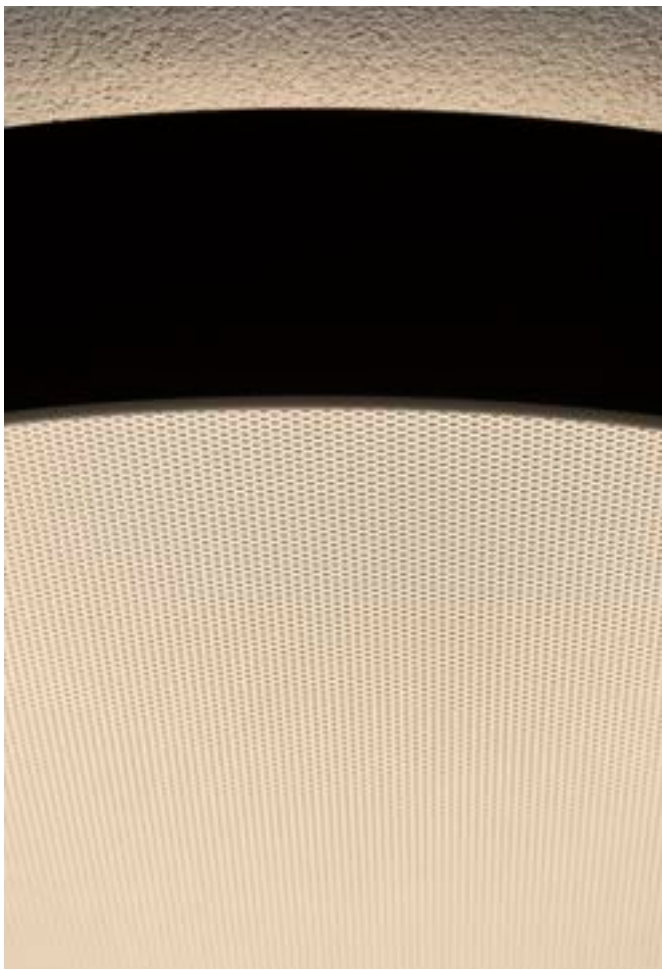







## FRAME

Base e montatura in metallo verniciato bianco opaco o nero opaco. Diffusori in materiale plastico colore opale. Emissione luce diretta.



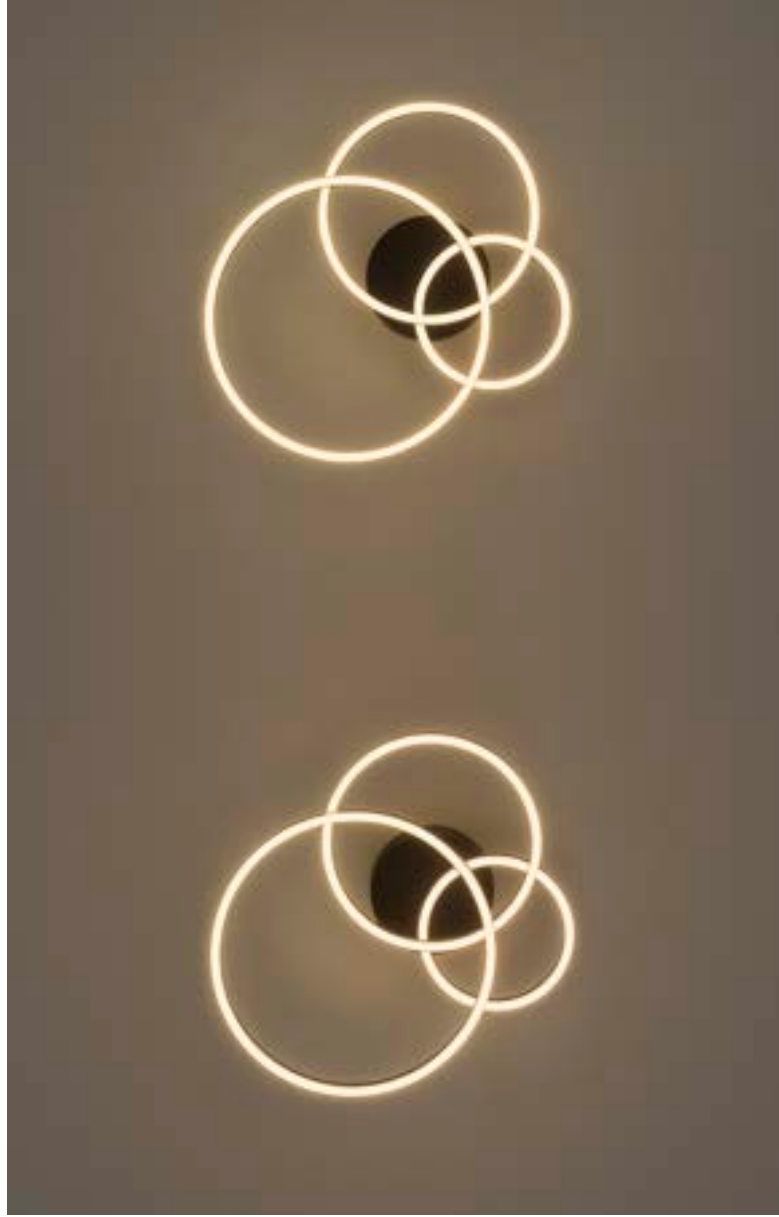





## NITRO

Corpo luce in alluminio verniciato bianco o nero opachi. Interno rifinito con mascherina in plastica. Sorgente luminosa a led integrato con lente.







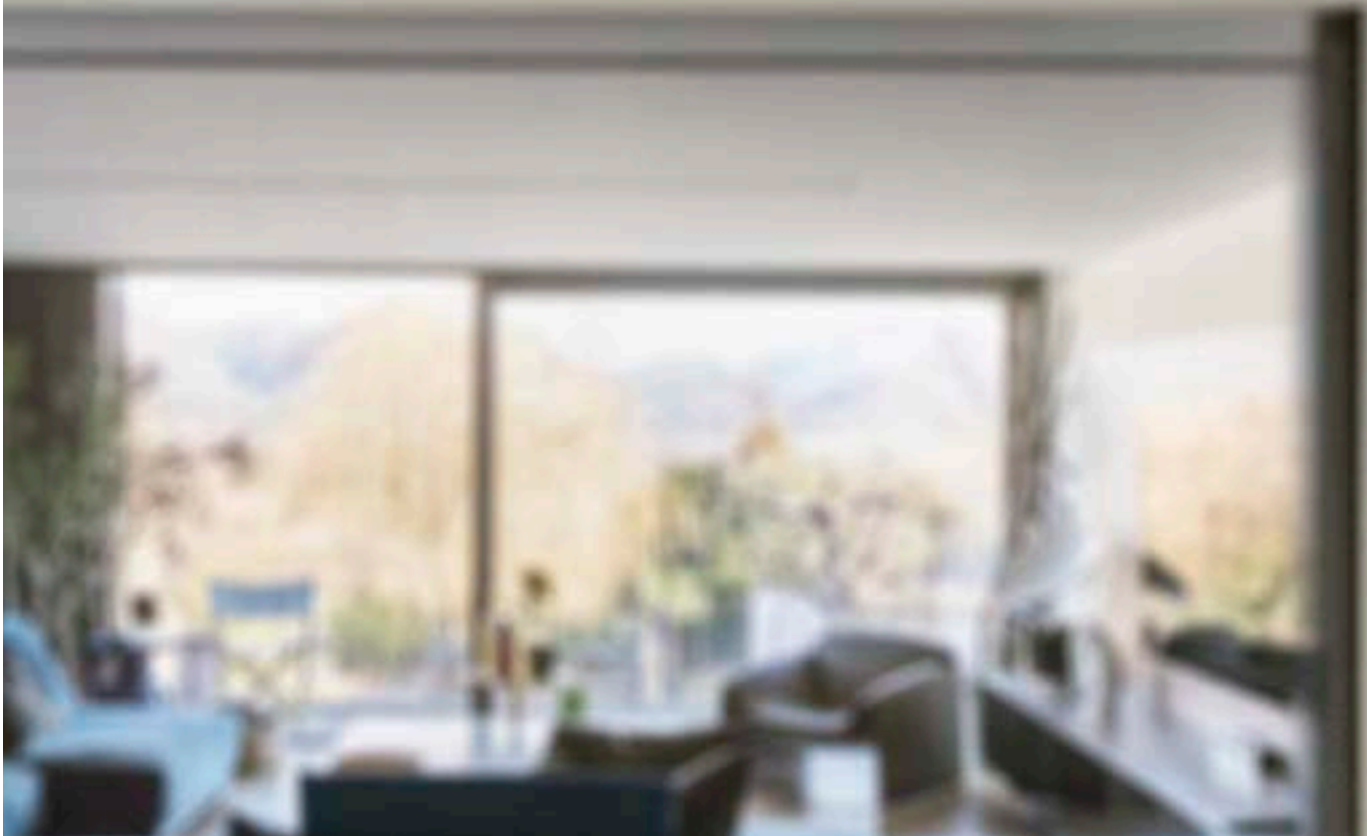





## SPIKE

Corpo luce in alluminio verniciato a polveri o placcato. Disponibile con sorgente GX53 o a led integrato con diffusore in policarbonato opale satinato. Colori: bianco, nero o ottone satinato.







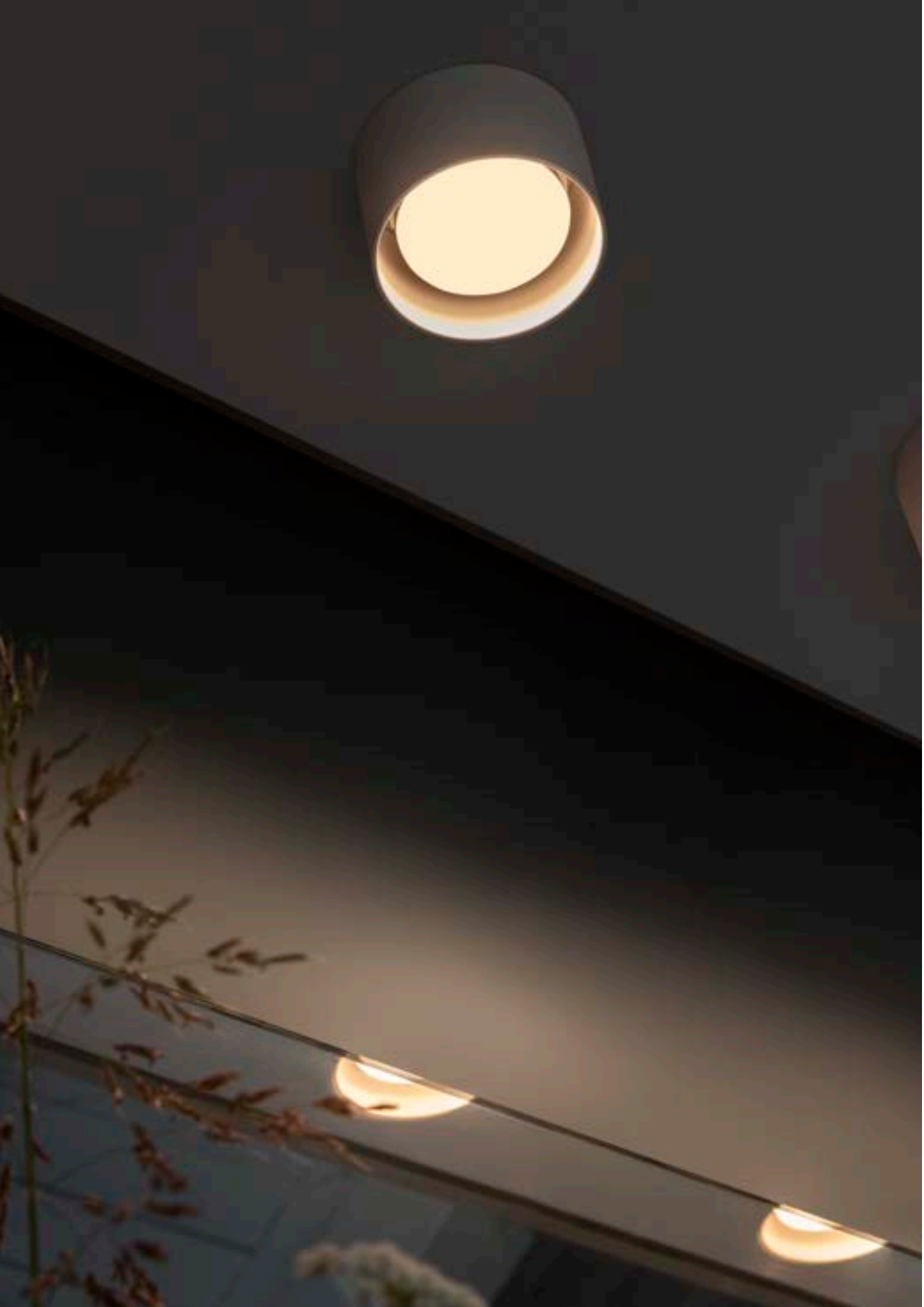



## LAMPADE DA PARETE

SOGNI  
CHE DANZANO,  
PAGINE APERTE,  
LUCE  
GENTILE,  
PAROLE CHE  
FLUTTUANO,  
ABBRACCI  
NOTTURNI,  
SILENZIO  
CHE CULLA,  
NOTTE  
CHE ASCOLTA,  
STORIE CHE  
S'INTRECCIANO,  
SOGNI CHE  
S'INNALZANO.





Indice

↳

144	<b>Bean</b>
148	<b>Binomio</b>
152	<b>Clip</b>
156	<b>Cover</b>
162	<b>Delta</b>
168	<b>Essence</b>
174	<b>Focus</b>
178	<b>Ninfea</b>
184	<b>Piano</b>
188	<b>Set Up</b>
192	<b>Zig Zag</b>

SOLO SCHEDE TECNICHE	490	Birds
	498	Equinoxe
	500	Filo
	600	Linus
	511	Look
	513	Mapa
	525	Oz
	527	Perlage
	533	Smarties



## BEAN

Base e diffusore orientabile  
in metallo placcato o verniciato  
a polveri. Colori bianco, nero  
oppure ottone o nickel  
con interruttore e snodo neri.











## BINOMIO

Montatura in metallo. Diffusori in vetro soffiato bianco acidato con fissaggio a vite. Finiture: bianco, nero, ottone spazzolato.













## CLIP

Corpo luce interamente in lamina di metallo con varie finiture. Nella versione piccola, diffusori in vetro pirex sabbato.



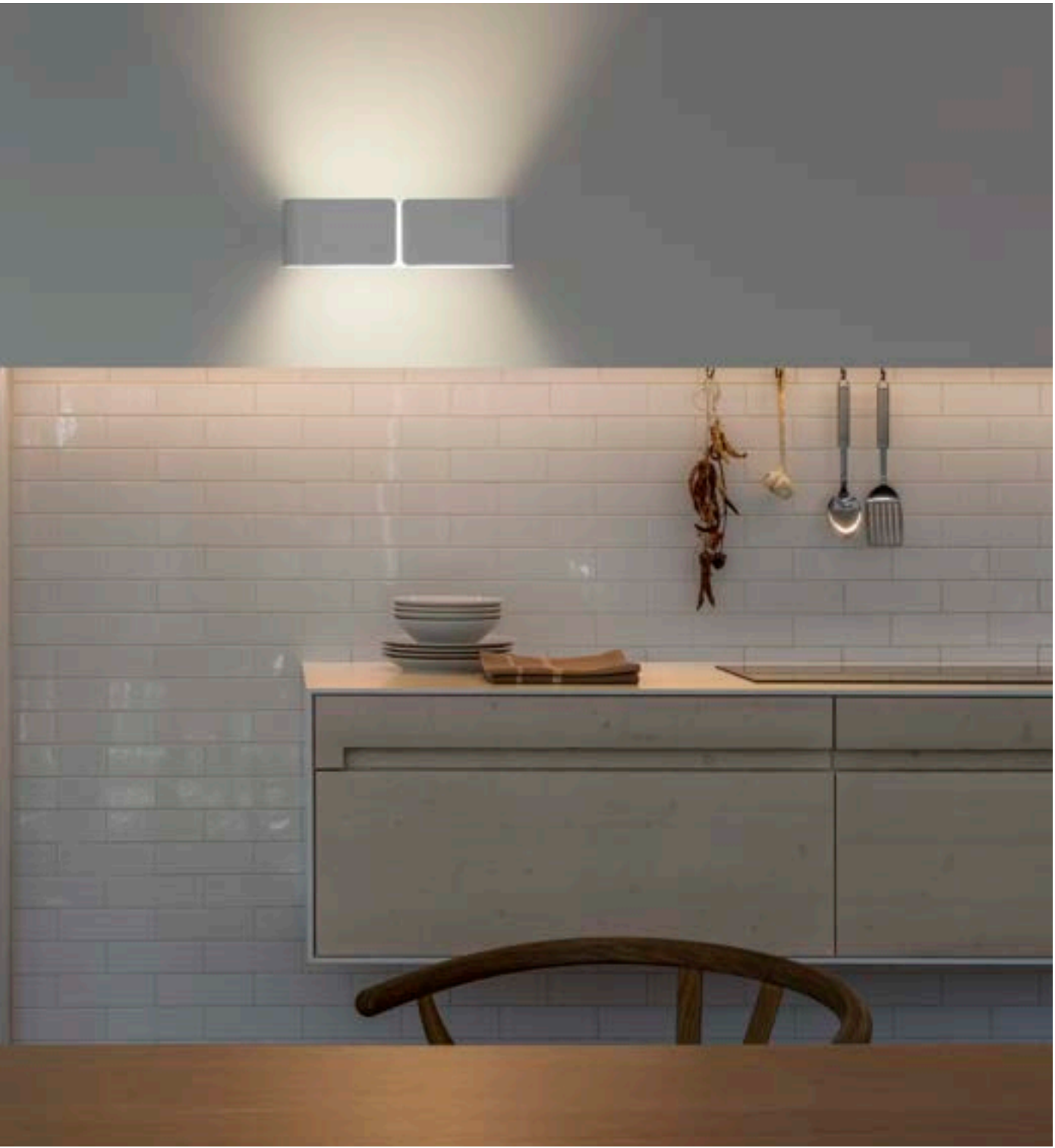







## COVER

Corpo luce in alluminio verniciato a polveri di colore bianco o nero. Diffusore in materiale plastico opale. Sorgente luminosa a led integrati con emissione di luce riflessa.

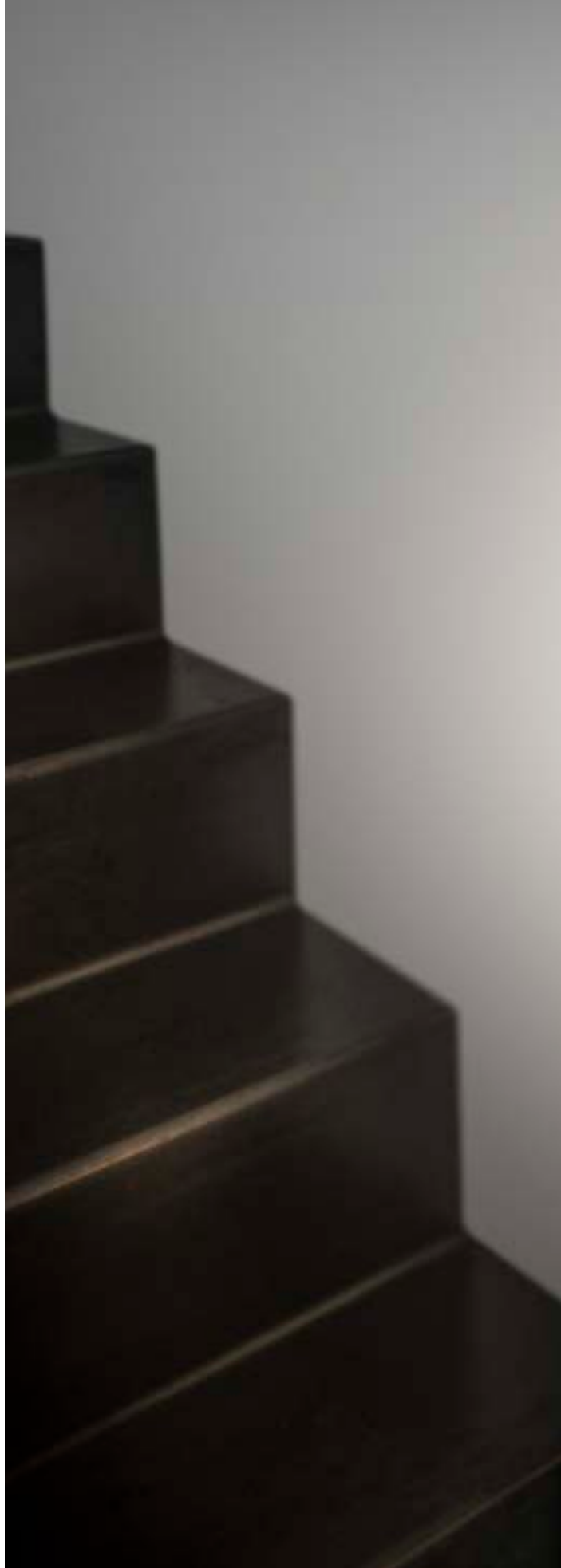















## DELTA

Corpo luce in alluminio verniciato a polveri. Diffusori in policarbonato opale lucido. Emissione luce sopra e sotto. Colori: bianco o nero.







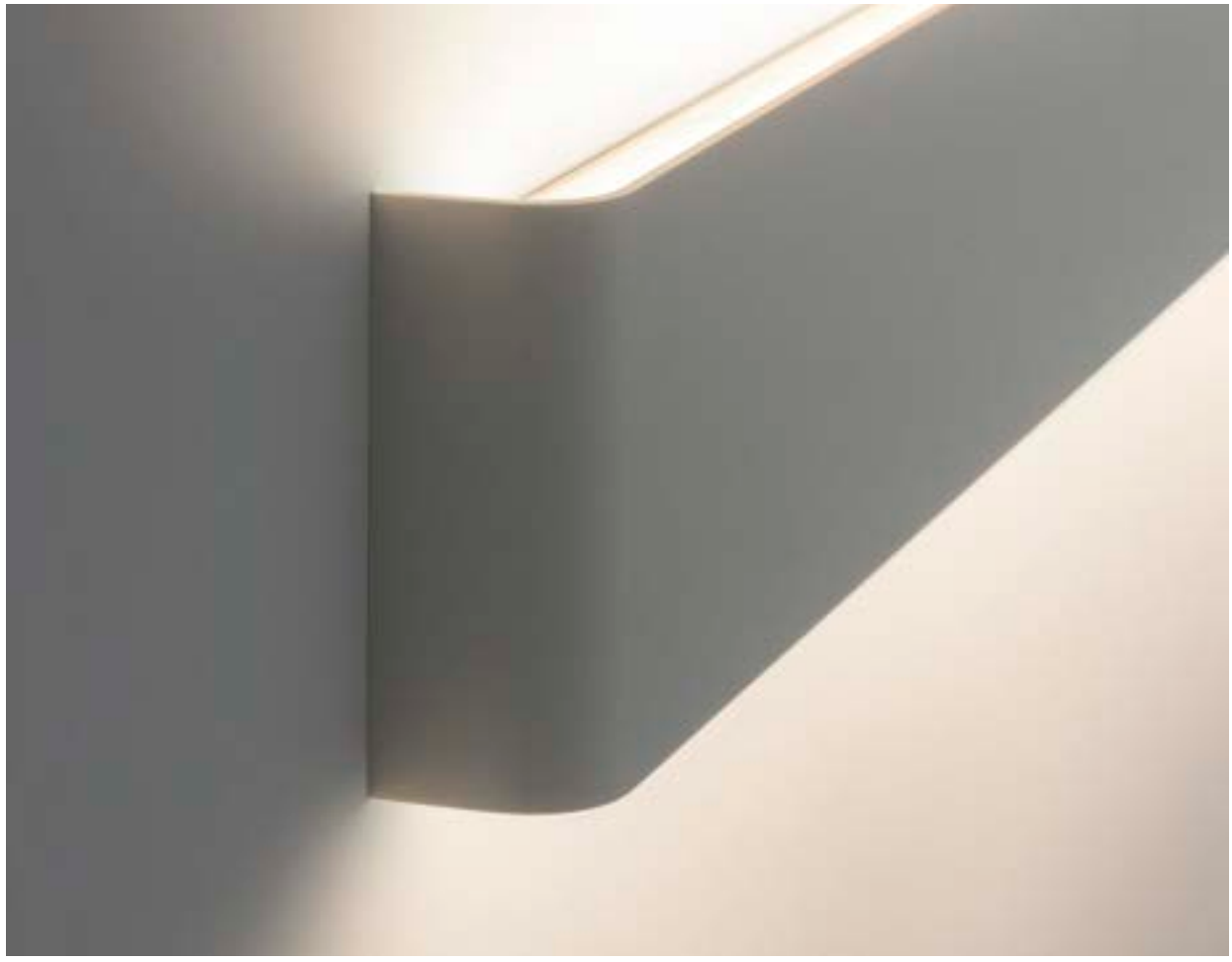

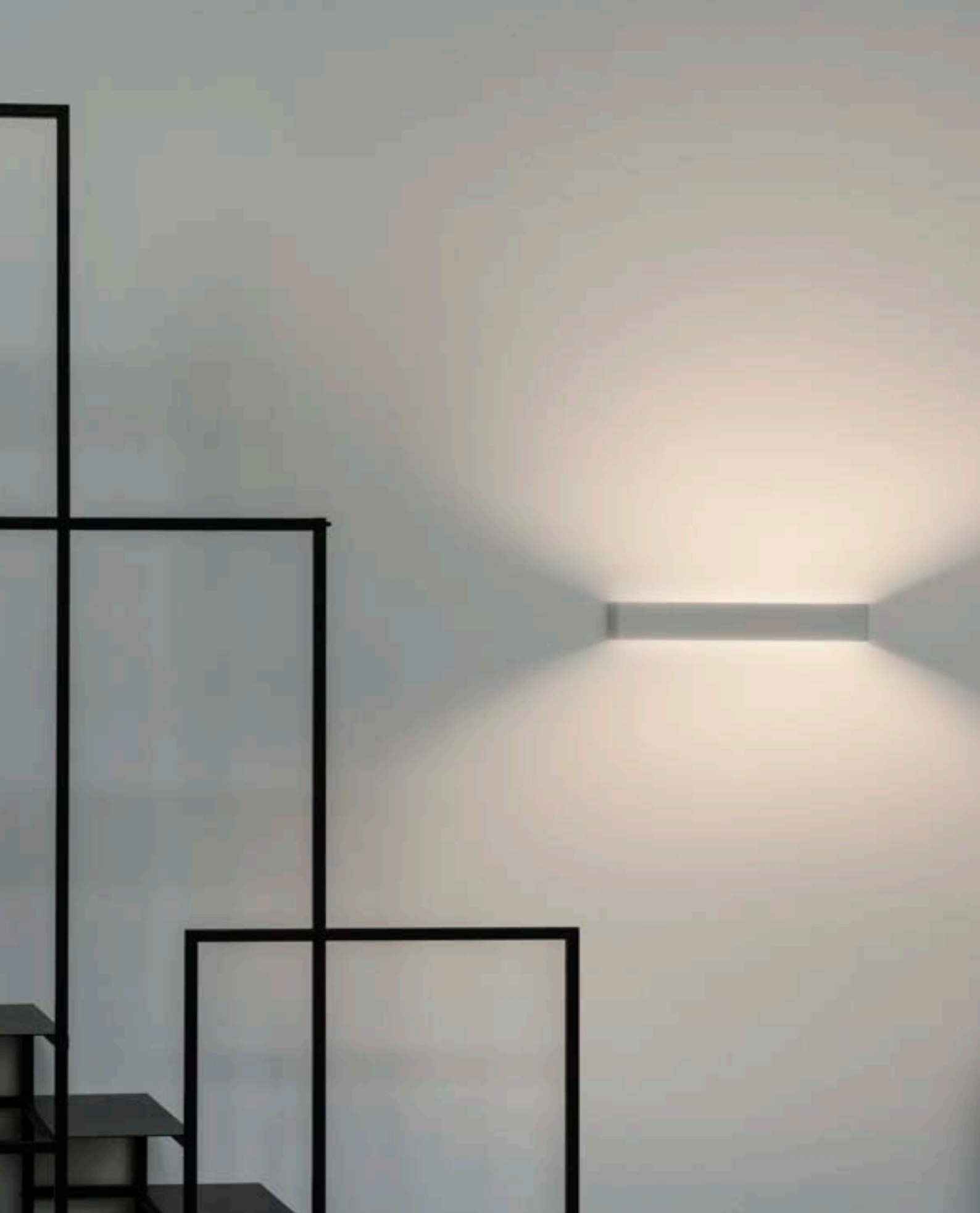







## ESSENCE

Base e corpo luce in alluminio verniciato a polveri.  
Diffusore in materiale acrilico opale. Emissione luce indiretta.  
Colori: bianco o nero.

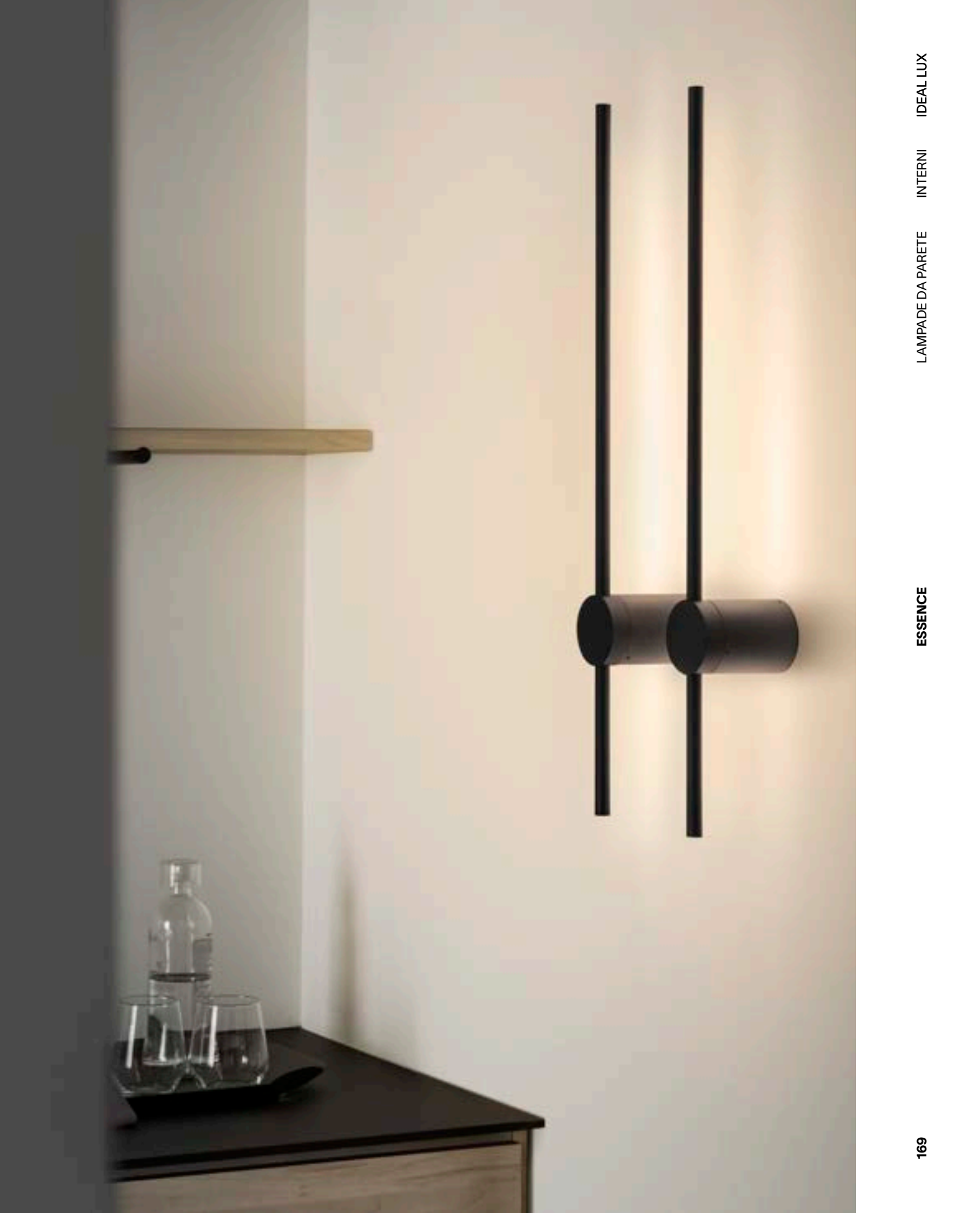











## FOCUS

Corpo luce in metallo con braccio flessibile orientabile rivestito in gomma. Rifinito in bianco o in nero opaco oppure in grigio con dettagli in cromo.











## NINFEA

Base in metallo verniciato a polveri o placcato. Diffusori in vetro incamiciato bianco, soffiato e acidato. Colori: bianco o ottone satinato.







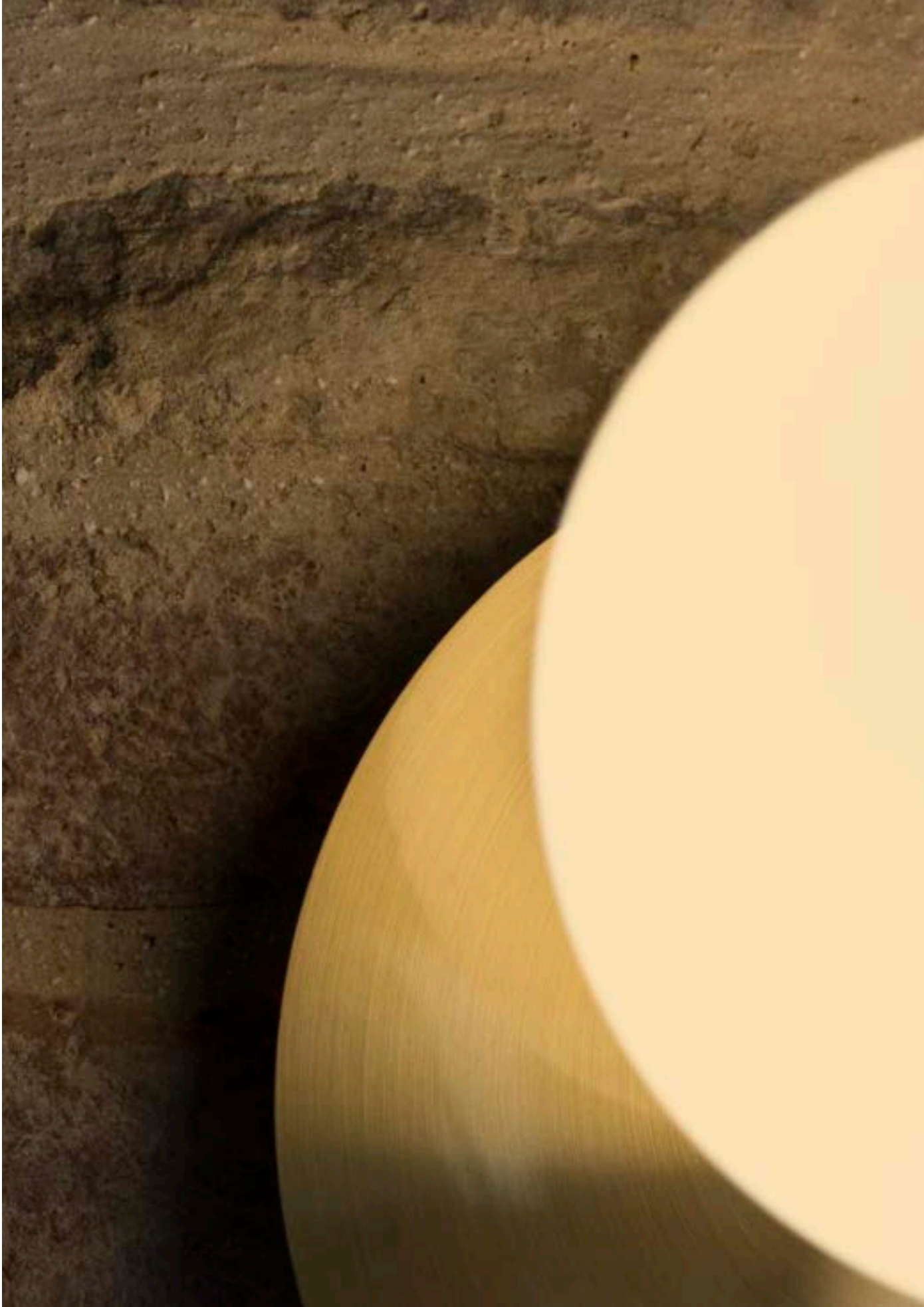







## PIANO

Montatura interamente in alluminio verniciato a polveri. Diffusore in policarbonato opale con emissione sul retro. Proiettore frontale orientabile. Colore: bianco o nero.









## SET UP

Montatura in metallo verniciato a polveri o placcato. Versione a due luci con braccio flessibile rivestito in gomma e interruttori indipendenti. Paralumi in pvc ignifugo rivestito di tessuto. Colori montature: bianco, nero, nichel satinato o ottone spazzolato con dettagli neri. Colori paralumi: beige, bianco, nero, tortora, legno.





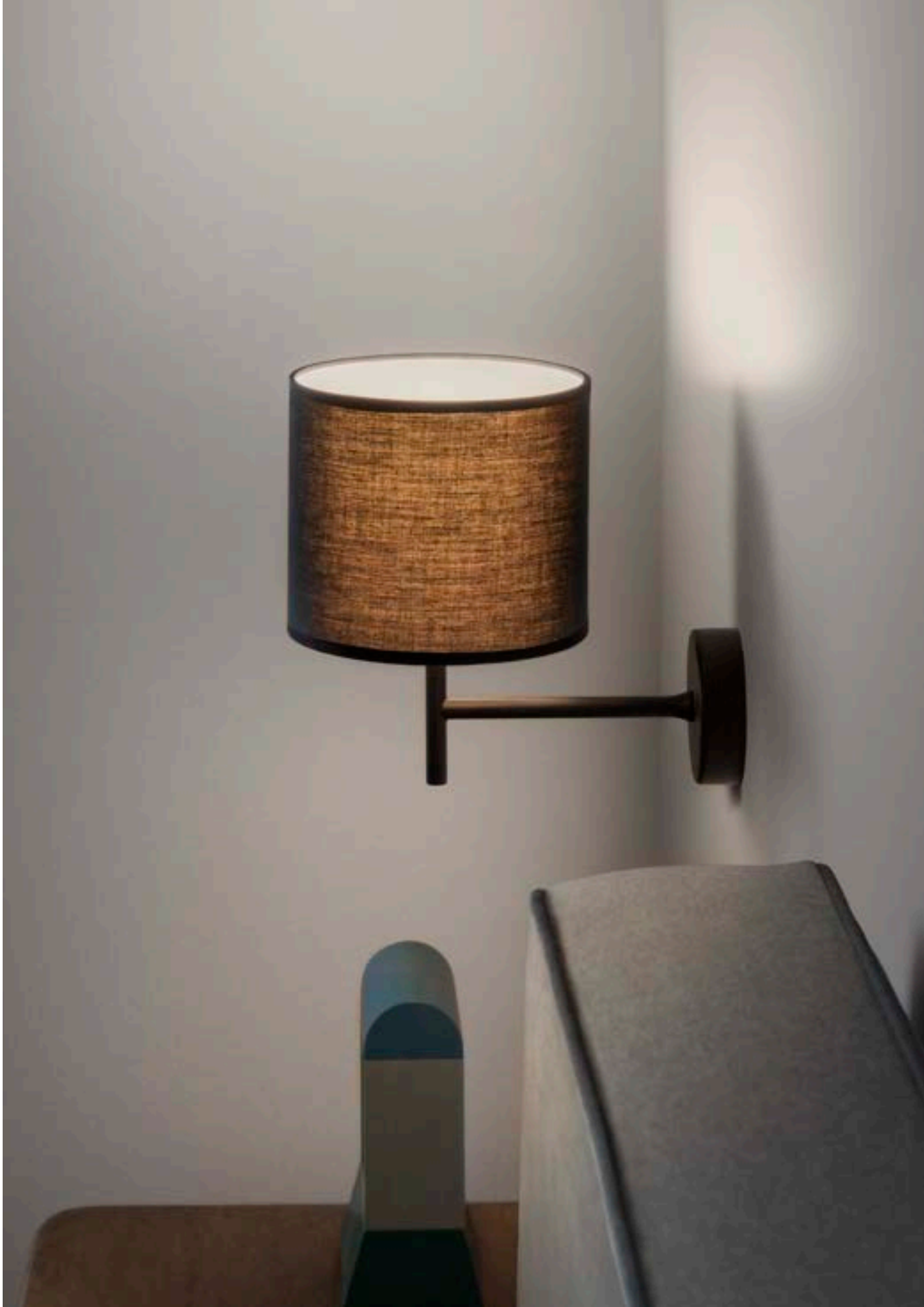







## ZIG ZAG

Corpo luce in alluminio placcato o verniciato a polveri. Emissione luce indiretta a 360°. Colori: bianco, nero o ottone spazzolato.



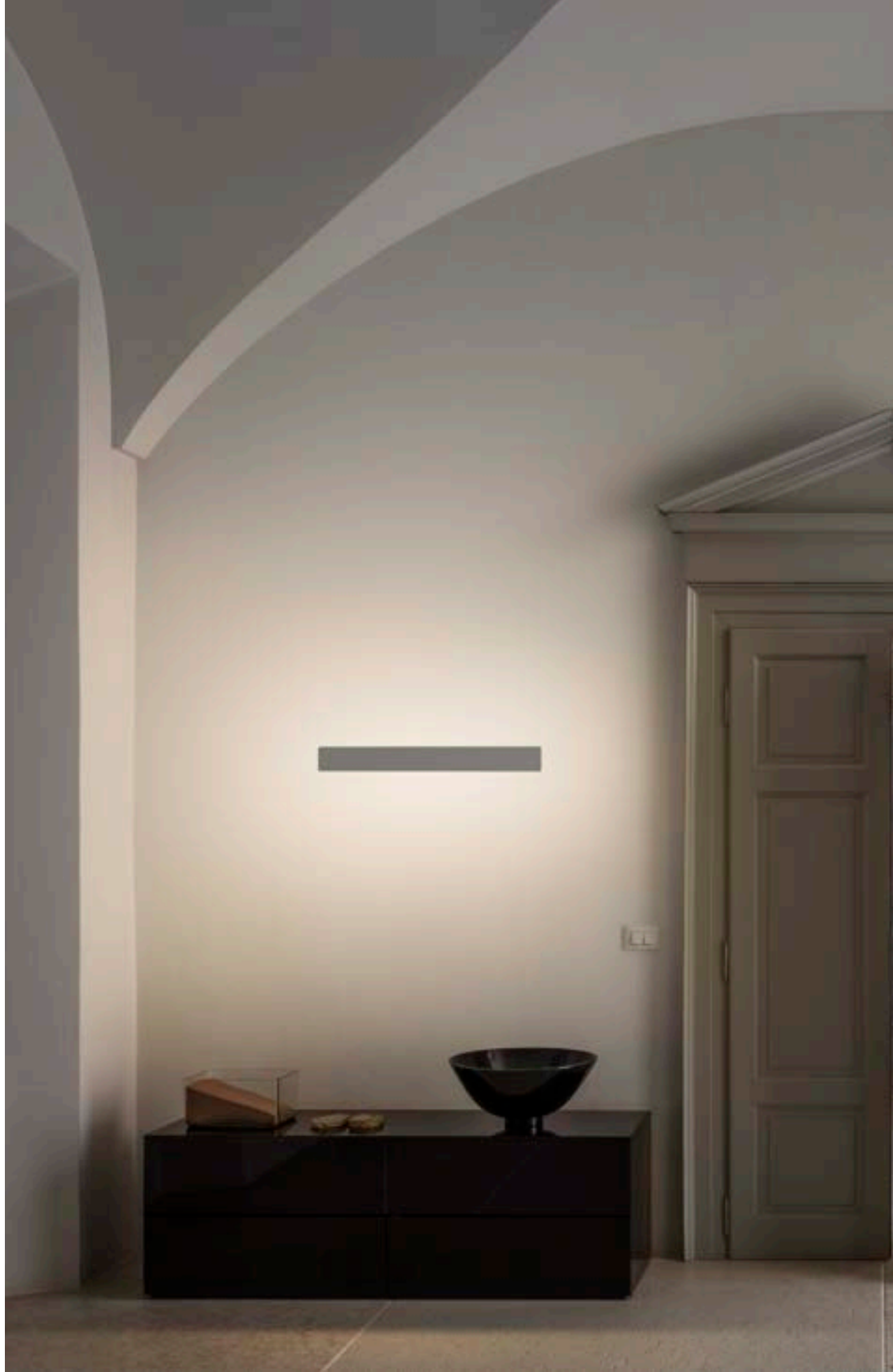





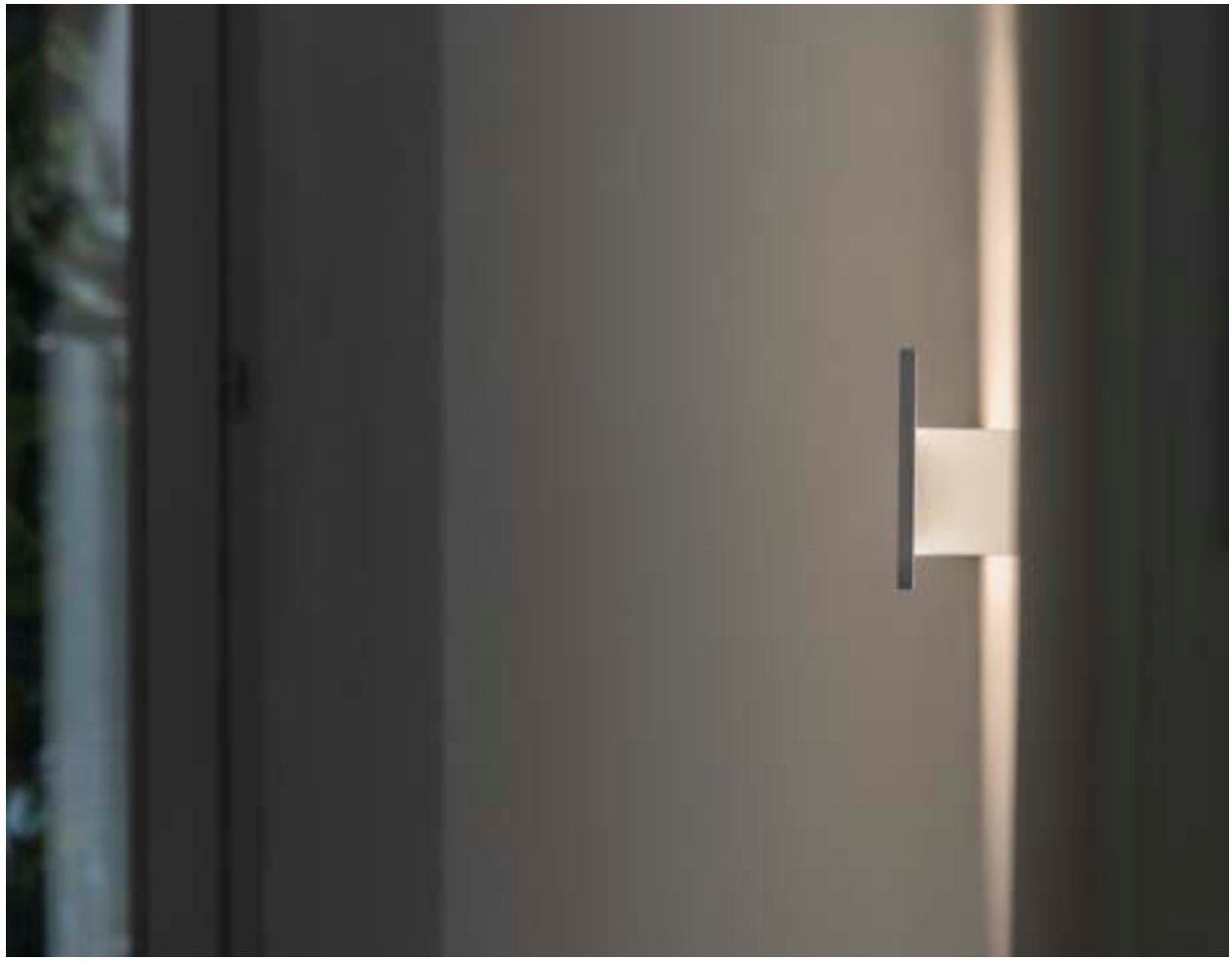

## LAMPADE DA TAVOLO

APPUNTI  
SCARABOCCHIATI,  
IDEE  
GERMOGLIATE,  
LUCE  
ATTENTA,  
CHE ISPIRA.  
IDEE  
ILLUMINATE,  
CONCENTRAZIONE  
COSTANTE.  
PENSIERI  
FLUIDI,  
CHE DANZANO.







Indice

↳

200 **Futura**  
206 **Mapa**  
212 **Oz**  
220 **Set Up**

SOLO SCHEDE TECNICHE

490	Birds
493	Diesis
501	Filo
527	Perlage
533	Smarties



## FUTURA

Braccio in alluminio e plastica,  
snodato con cavo a vista in pvc.  
Diffusore orientabile a led  
e interruttore incorporato.  
Spina con alimentatore.









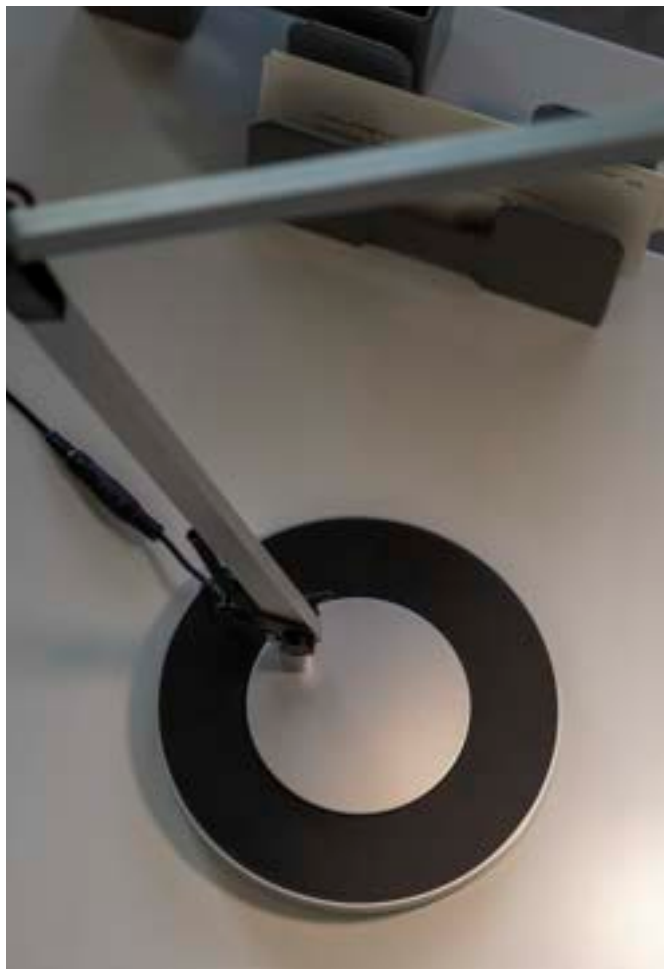

# MAPA

Base e sistema di fissaggio  
in metallo bianco. Diffusore a sfera  
in vetro bianco soffiato e acidato.









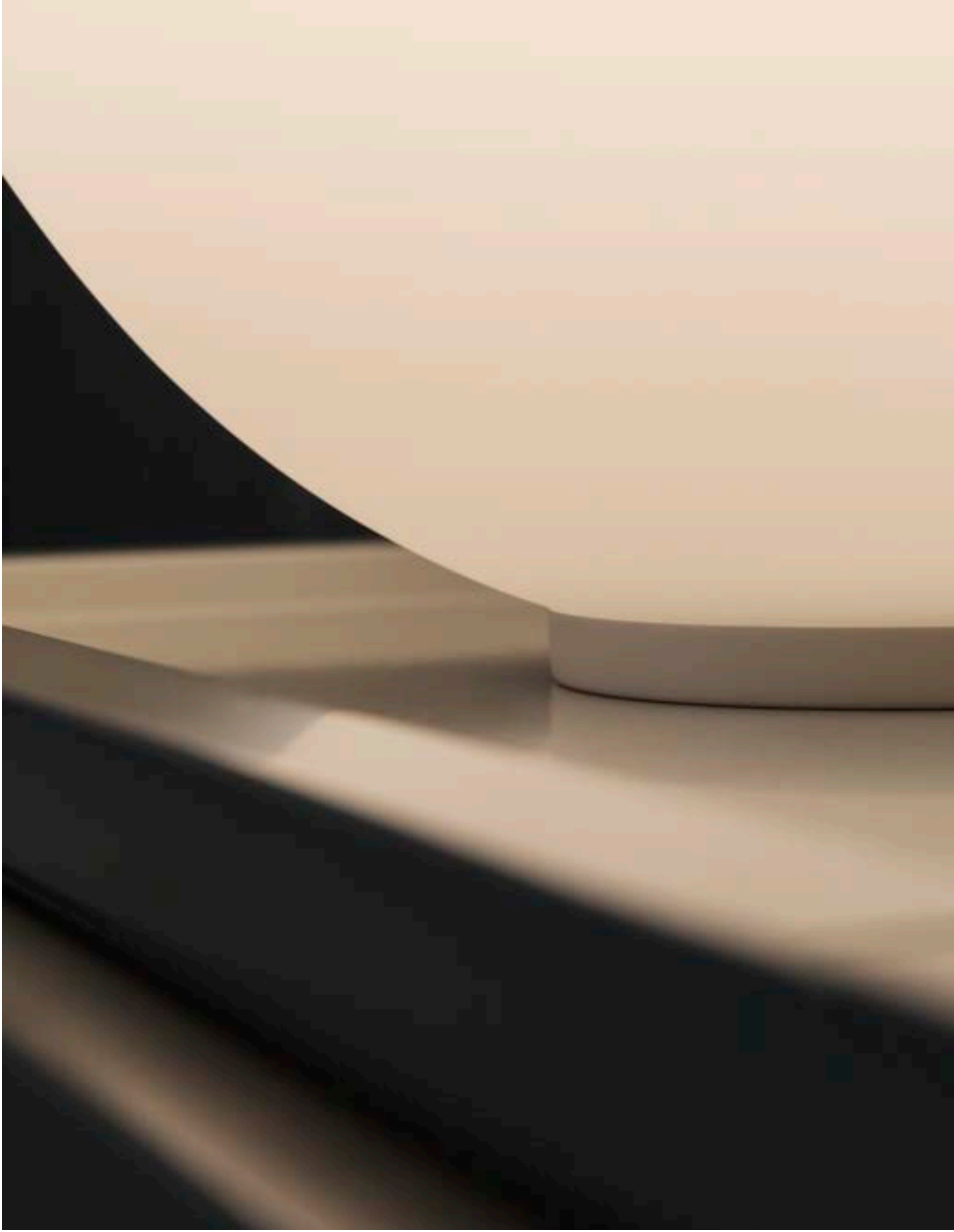

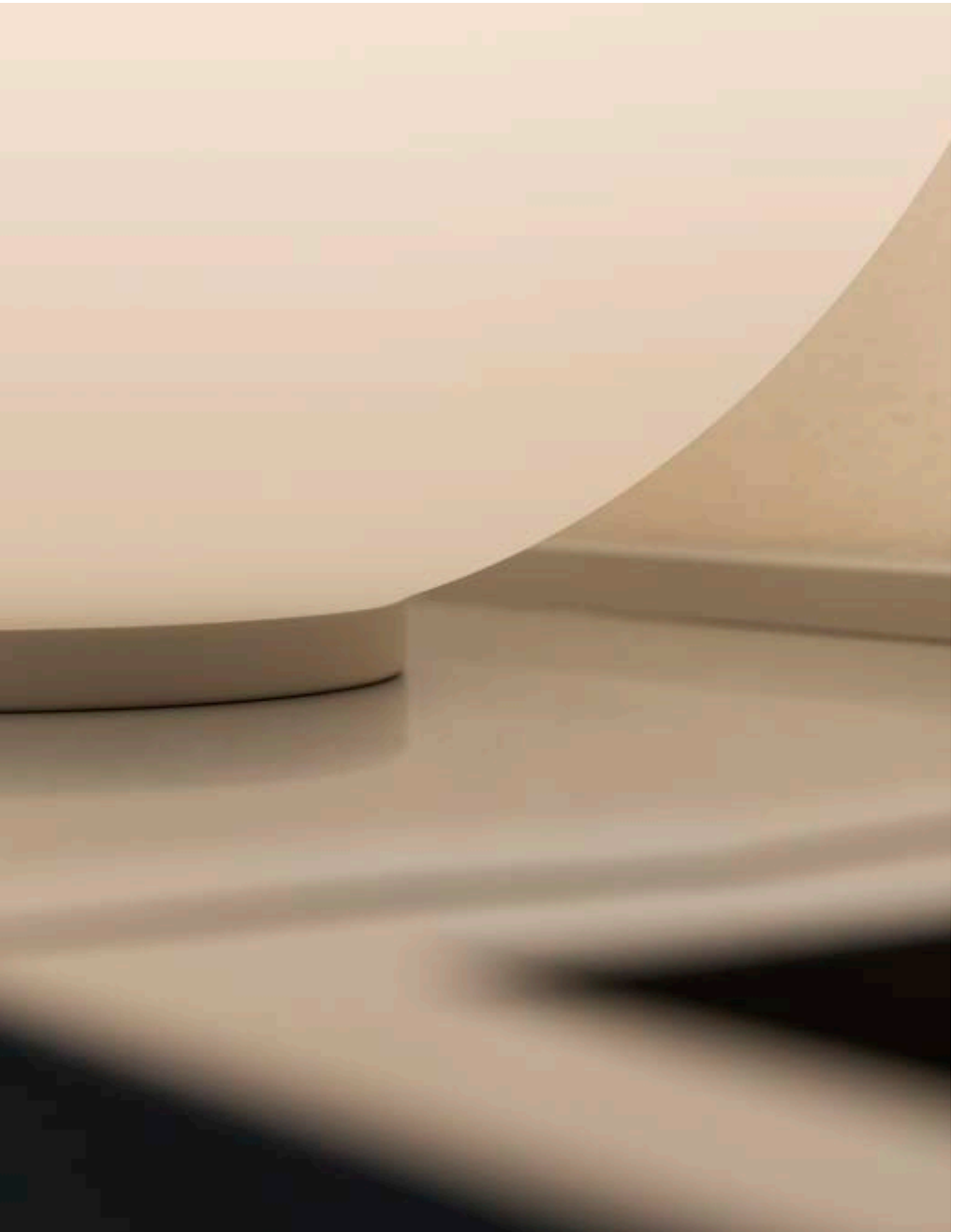

## OZ

Base e montatura in metallo verniciato a polveri o placcato. Cavi in pvc. Diffusore in gomma opale. Disponibile nelle finiture bianco, nero o ottone spazzolato.

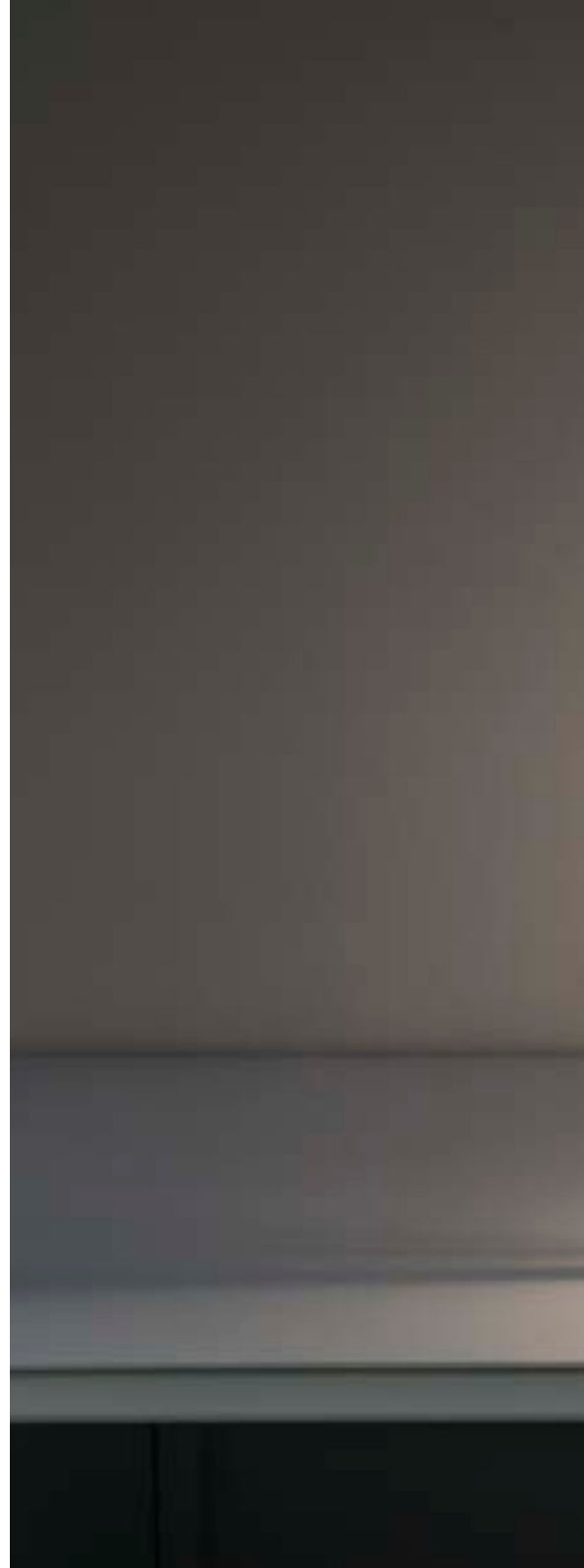











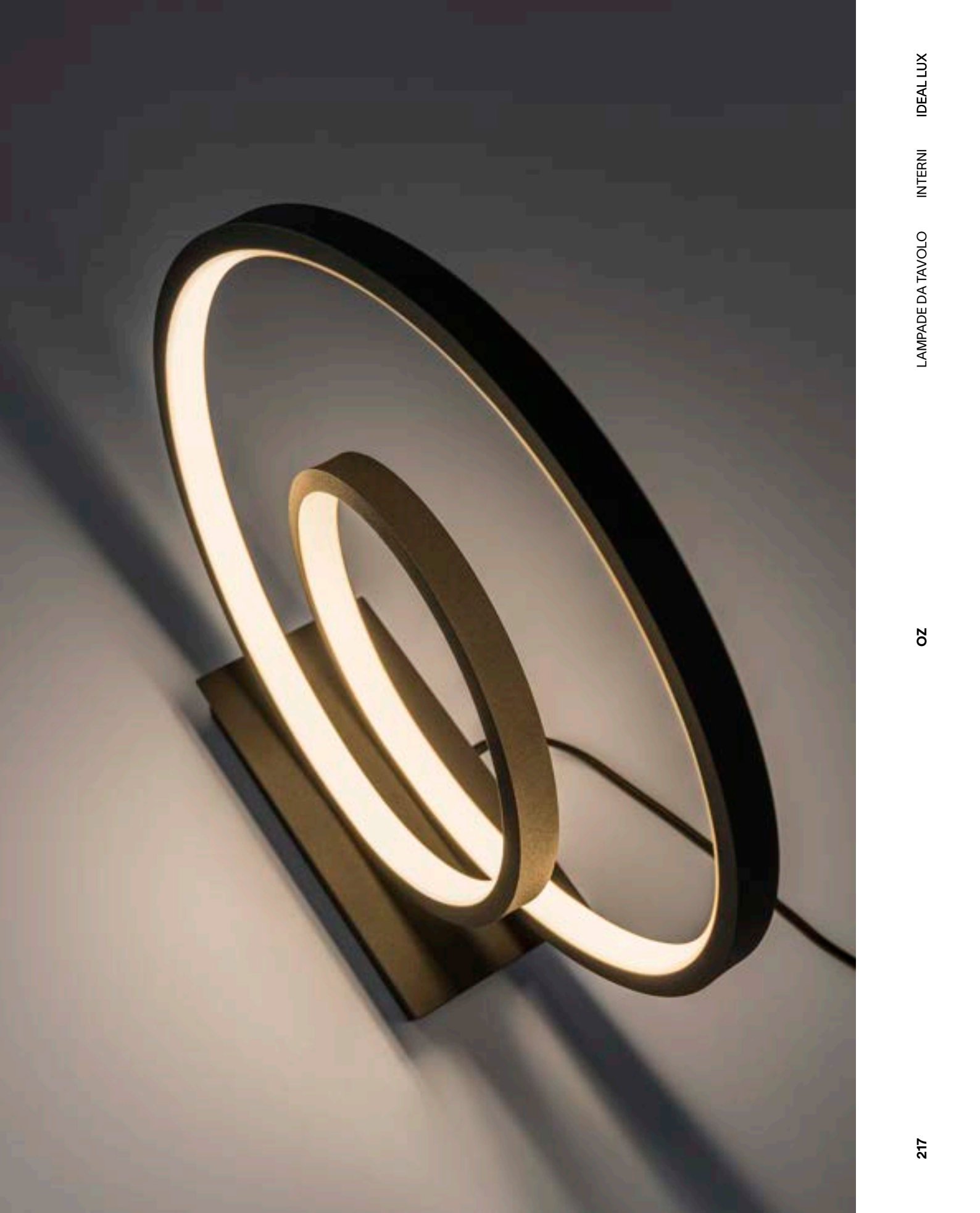







## SET UP

Montatura in metallo verniciato a polveri o placcato. Paralumi in pvc ignifugo rivestito di tessuto. Cavo in pvc. Colori montature: bianco, nero, nichel satinato o ottone spazzolato. Colori paralumi: beige, bianco, nero, tortora, legno.

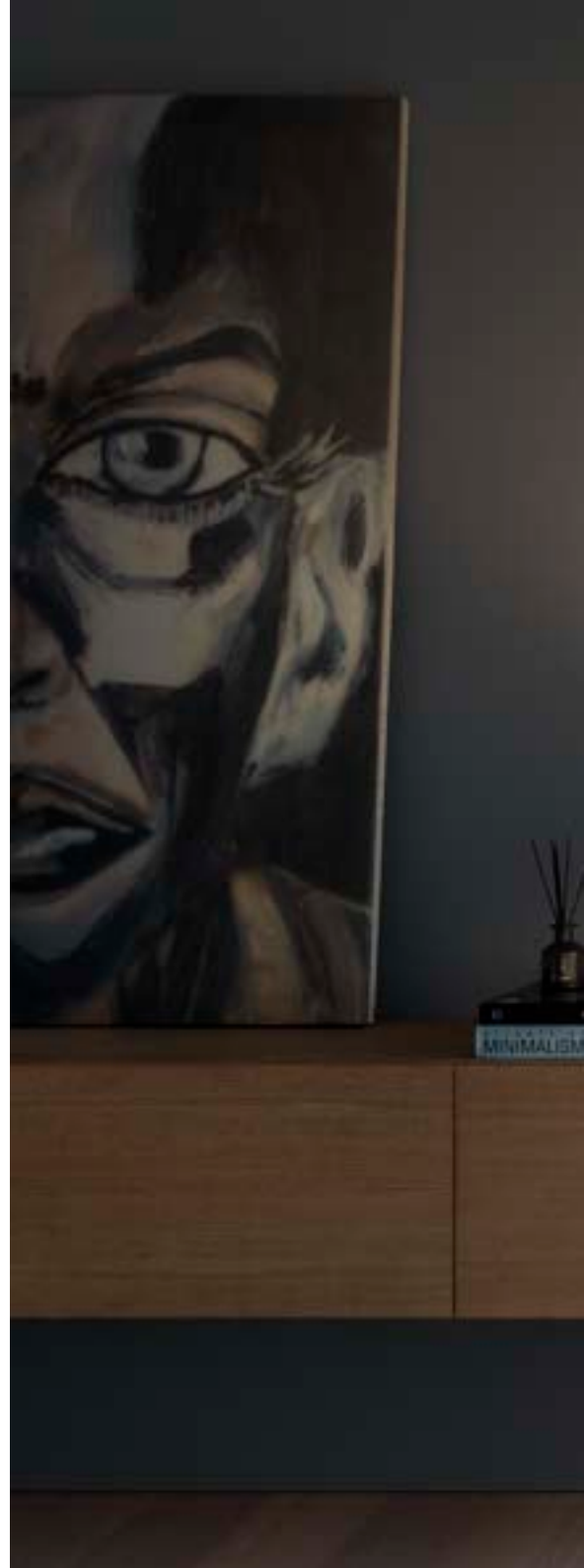



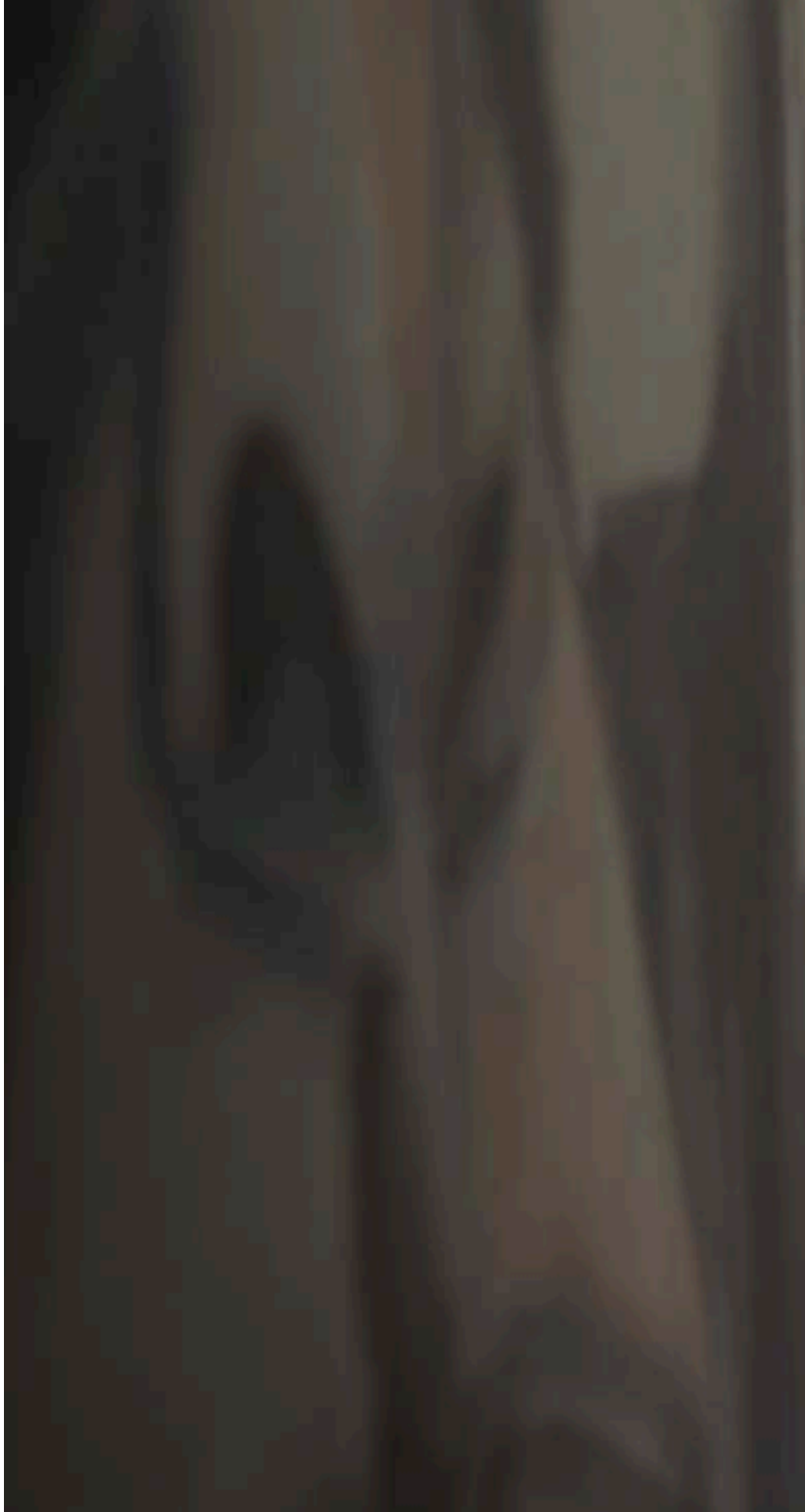









9905

## LAMPADE DA TERRA

PASSI  
CHE RISUONANO,  
CASA  
CHE ASPETTA.  
LUCE  
CHE ABBRACCIA.  
LA CALMA  
SI DIFFONDE,  
IL RIPOSO  
SI FA CONFIDENZA,  
I RICORDI  
DANZANO  
NELL'ARIA.





Indice



228 **Birds**  
234 **Diesis**  
242 **Dorsale**  
248 **Equinoxe**  
254 **Filo**  
260 **Perlage**  
266 **Set Up**

SOLO SCHEDE TECNICHE

495	Ego
507	Frame
508	Futura
511	Look
516	Mix Up



## BIRDS

Montatura in metallo verniciato con disco decorativo in ottone satinato. Diffusori in vetro soffiato bianco acidato. Cavo in pvc con interruttore e spina. Colore: nero opaco con dettaglio ottone satinato.

















## DIESIS

Montatura in metallo verniciato a polveri o placcato. Diffusore orientabile in rotazione e inclinazione. Cavo in pvc con interruttore. Colori: nero, nickel satinato oppure ottone satinato.





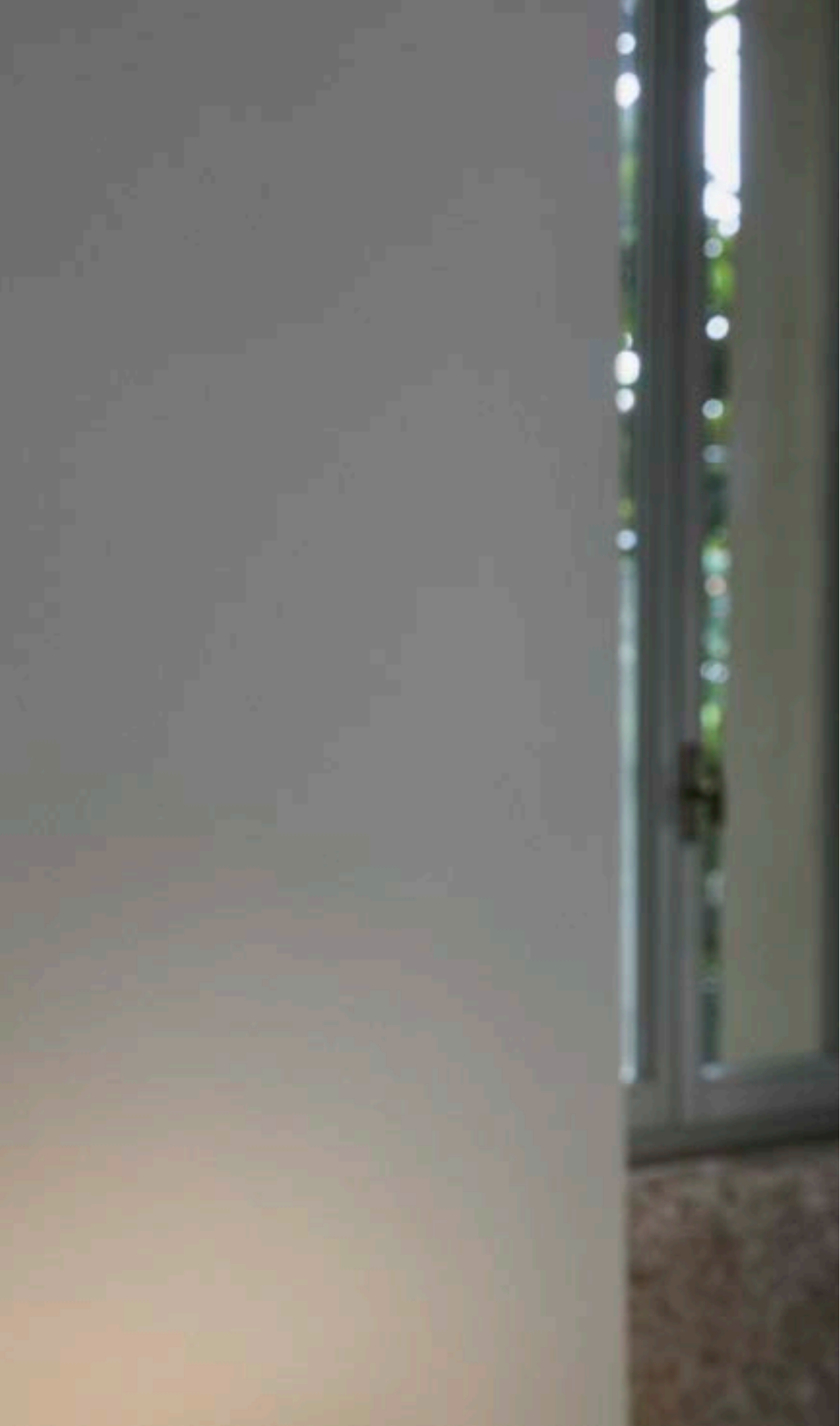













## DORSALE

Montatura in metallo rifinito in cromo o con vernice opaca bianca o nera. Braccio a sezione quadrata composto da tre elementi. Paralume in lamina di PVC, disponibile in colore cromo o rivestita in tessuto bianco o nero.

















## EQUINOXE

Montatura in metallo placcato.  
Diffusori in vetro borosilicato  
trasparente. Cavo in pvc nero.  
Colori: montatura cromo con  
vetro trasparente o fumè sfumato,  
montatura ottone antico con vetro  
trasparente o ambra sfumato.















## FILO

Rosone, corpo luce e base a terra in metallo verniciato a polveri o placcato. Diffusore in PC opale satinato. Cavo di sostegno in PVC nero. Alimentato dalla base a terra da cavo nero in PVC con spina. Finiture: bianco, nero oppure ottone.





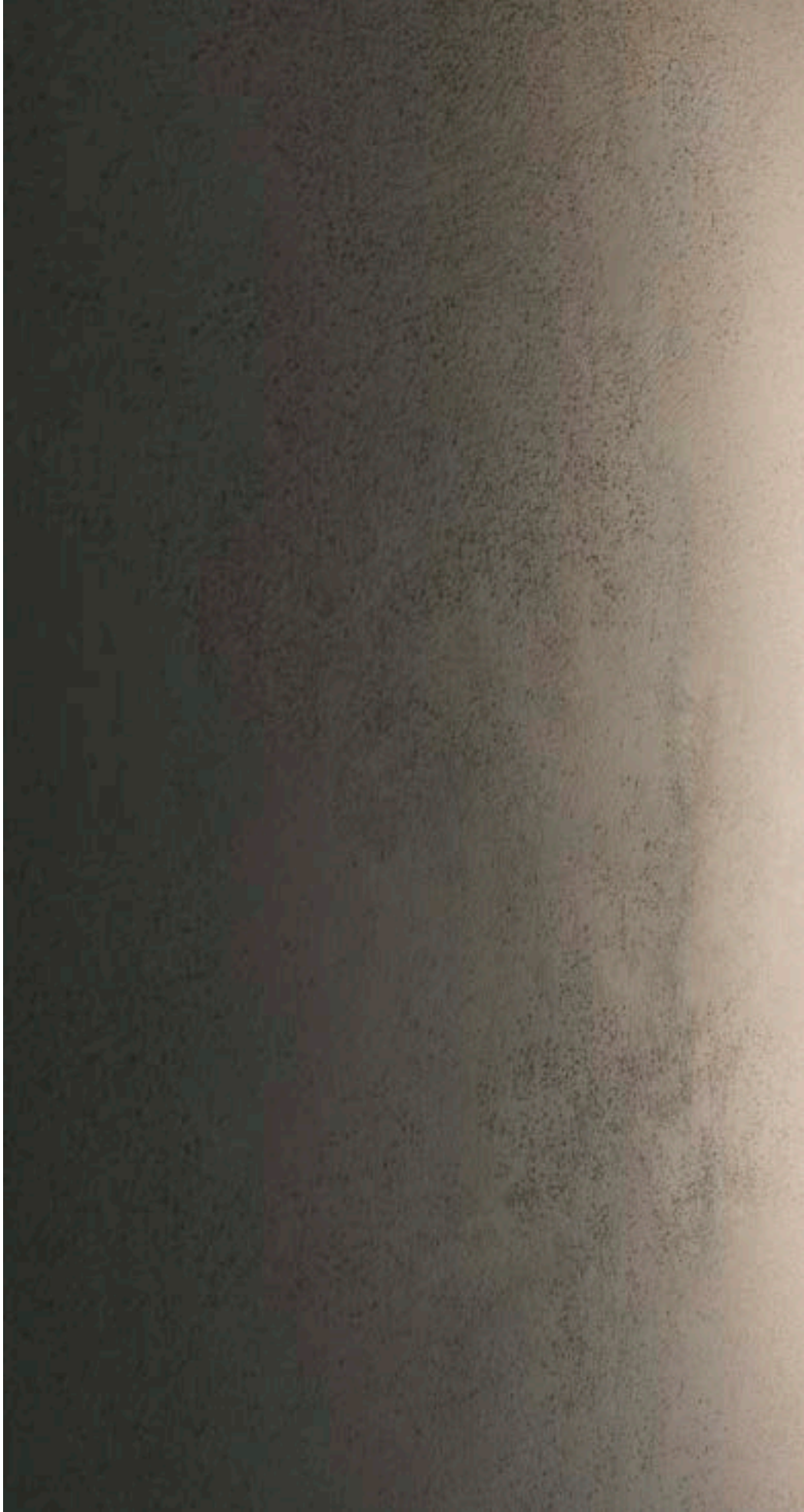



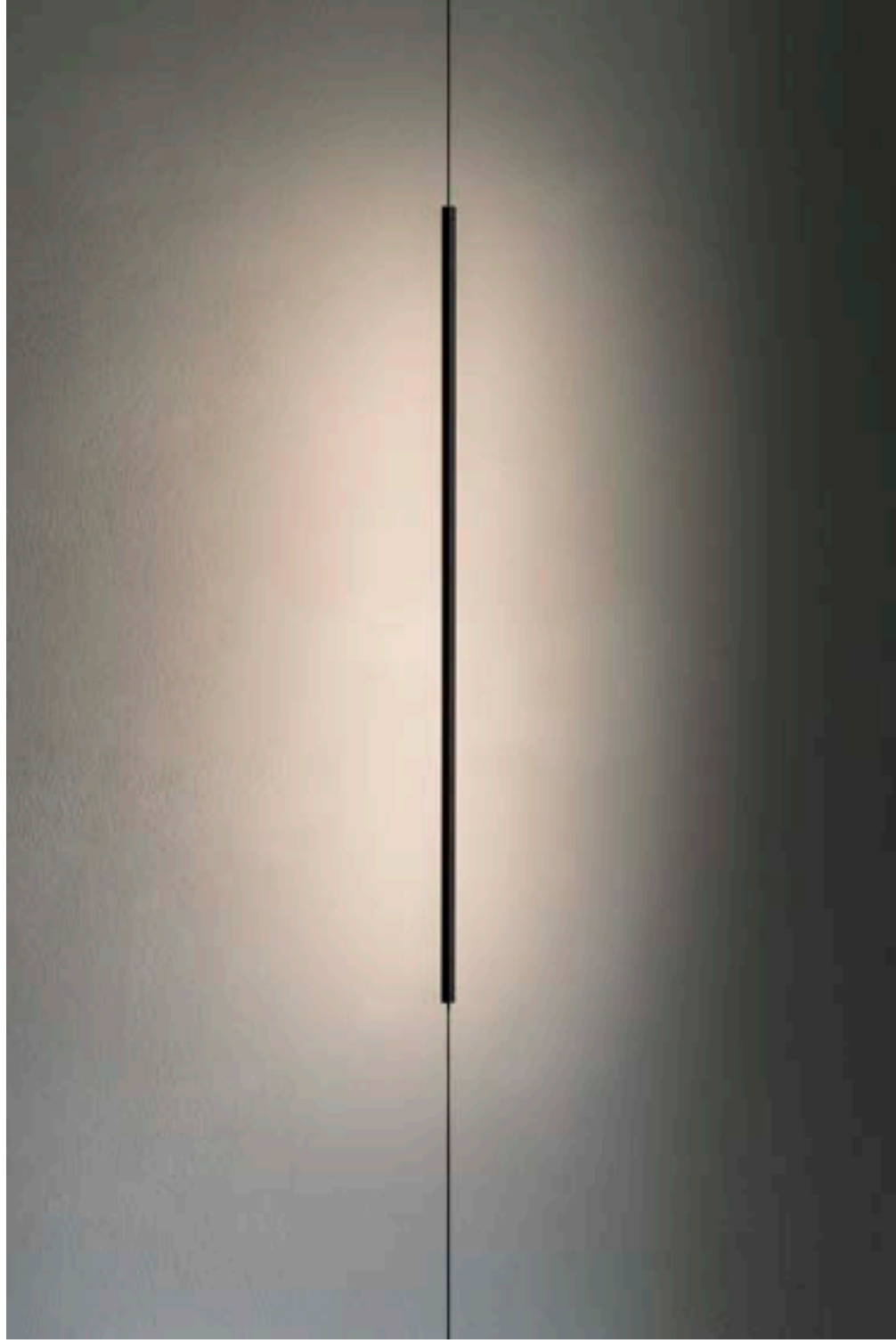





## PERLAGE

Montatura in metallo. Diffusori in vetro soffiato. Finiture: nero opaco con vetri ambra o pirex fumé oppure ottone satinato con vetri bianchi acidati.















## SET UP

Montatura in metallo verniciato a polveri o placcato. Paralumi in pvc ignifugo rivestito di tessuto. Cavo in pvc. Colori montature: bianco, nero, nichel satinato o ottone spazzolato. Colori paralumi: beige, bianco, nero, tortora, legno.







## SISTEMI, PROIETTORI E BINARI

LIBRO  
APERTO,  
LUCE CHE  
SI POSIZIONA,  
PAGINE  
CHE VOLANO,  
PAROLE CHE  
SI ESPANDONO,  
CONTORNI  
CHE SI  
DELINEANO,  
OCCHI CHE  
SI POSANO,  
MENTE  
CHE SI APRE,  
ANIMA  
CHE SI LIBERA.







Indice



272 **Deva**  
278 **Display**  
286 **Ego**  
306 **Eos**  
314 **Fluo**  
320 **Fox**  
324 **Linus**  
330 **Quick**  
336 **Tesi**

SOLO SCHEDE TECNICHE

588 **Link**  
512 **Look**  
604 **Spike Track**



## DEVA

Sistema lineare composto da un profilo in alluminio estruso ed elementi di illuminazione a fissaggio magnetico. Il sistema è disponibile in colore nero opaco verniciato o anodizzato, nella modalità d'installazione a plafone o sospensione (SURFACE), incasso rapido a scomparsa nel cartongesso (RECESSED EASY) o incasso senza bordo fra due pannelli di cartongesso (RECESSED). Possibilità di composizione con diversi moduli luminosi a seconda della disposizione desiderata, modificabile all'occorrenza.















## DISPLAY

Proiettore lineare in alluminio verniciato per binario trifase LINK, finitura bianca o nera, diffusore in PMMA. Disponibile nel modello WIDE diffondente, nel modello UGR microprismatizzato e nel modello ACCENT (UGR < 16). Il driver di alimentazione integrato è alloggiato all'interno del binario per minimizzare l'ingombro del prodotto visibile.

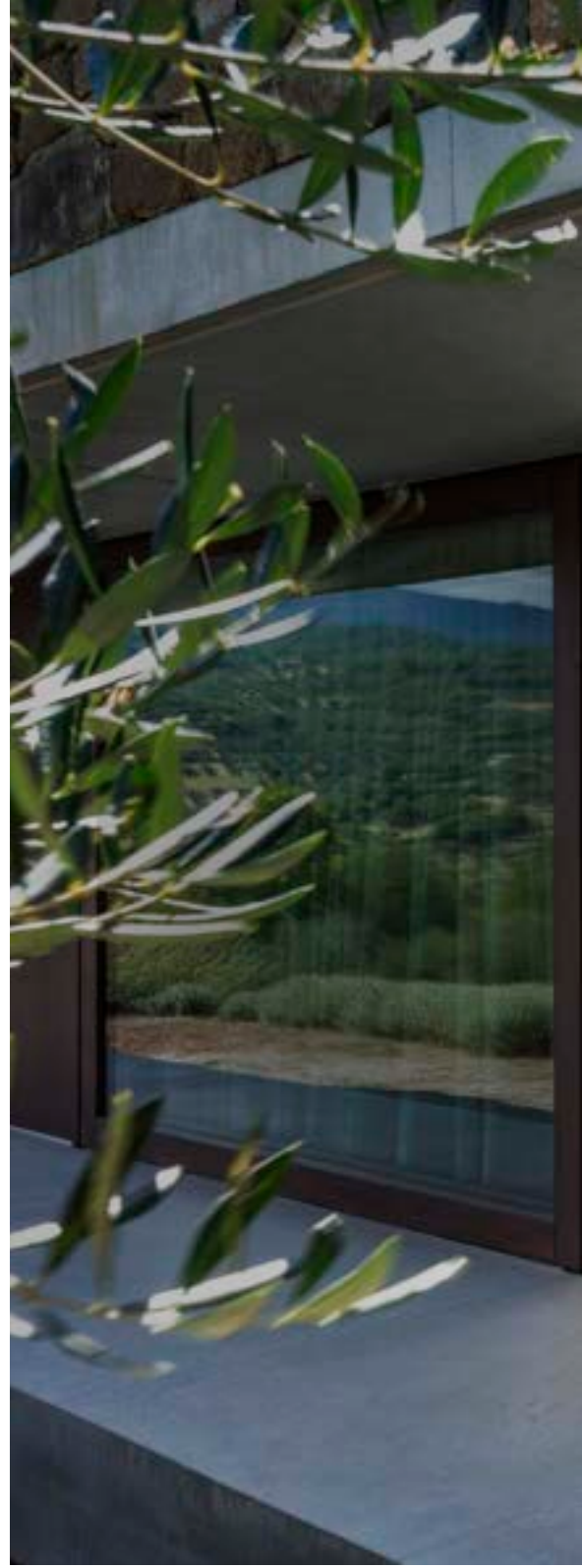



















## EGO

Sistema lineare composto da un profilo in alluminio estruso ed elementi di illuminazione con fissaggio meccanico di sicurezza. Il sistema è disponibile in colore nero opaco RAL 9005, bianco opaco RAL 9016 oppure ottone satinato anodizzato, nella modalità d'installazione a plafone o sospensione (LOW e HIGH), incasso senza bordo a scomparsa nel cartongesso (RECESSED), incasso rapido nel cartongesso (RECESSED EASY) o incasso con bordo per controsoffitti in cartongesso o a pannelli (RECESSED TRIM).

Possibilità di composizione con diversi moduli luminosi a seconda della disposizione desiderata, modificabile all'occorrenza.

Ideale per l'illuminazione di piccoli e grandi ambienti dove viene richiesta ampia flessibilità ed elevata qualità di illuminazione, ad esempio spazi museali, commerciali, residenziali e retail.







Indice  
EGO



555 **Accent**  
551 **Track Single**  
554 **Track Flat**  
556 **Wide**

SOLO SCHEDE TECNICHE

568	Bi-emission
572	Drivers
558	Flexible
562	High
560	Low
559	Pendant
564	Recessed
554	Track Big
553	Track Double
555	Track Zoom



## EGO Track Single

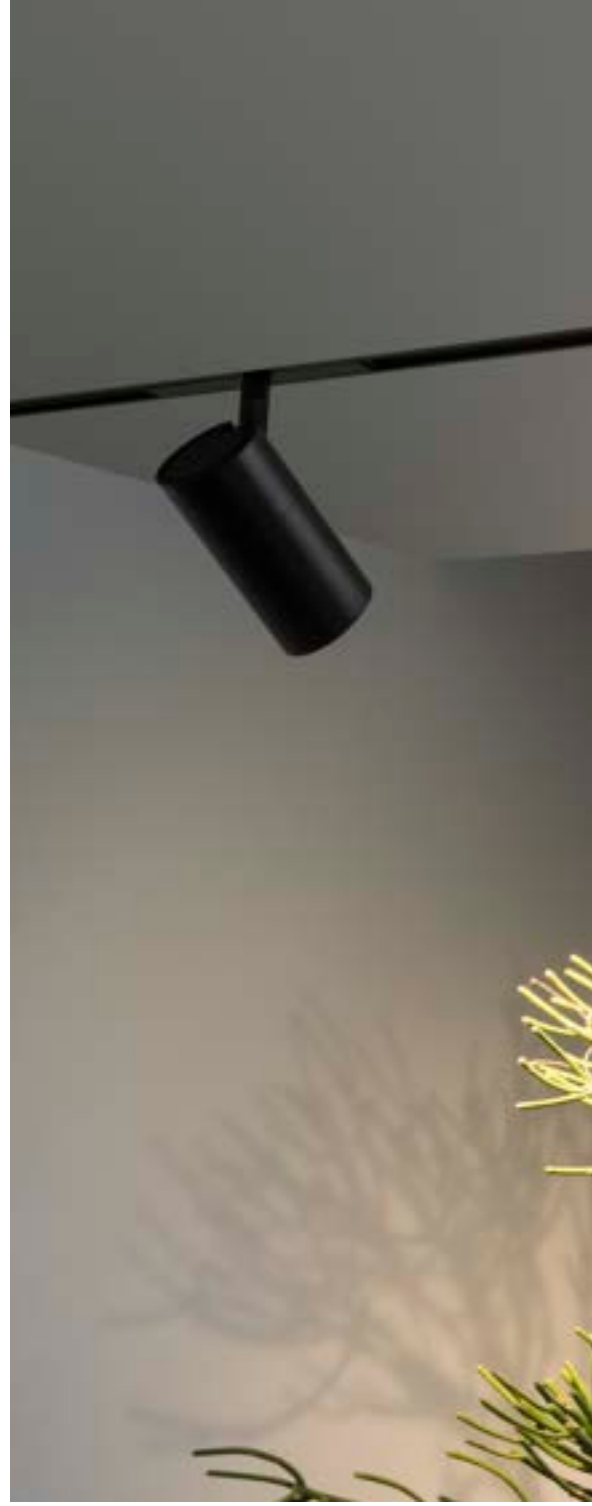









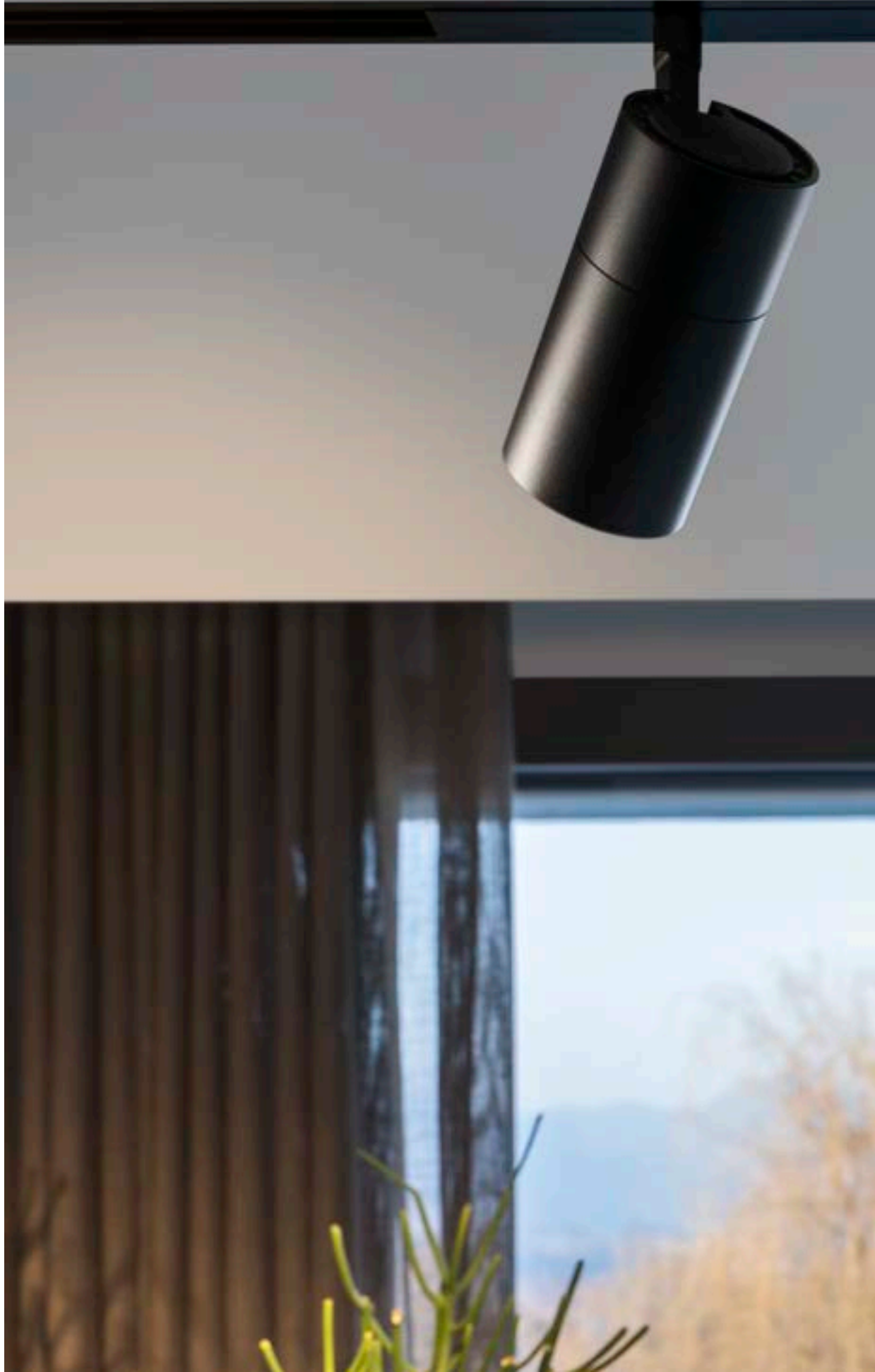

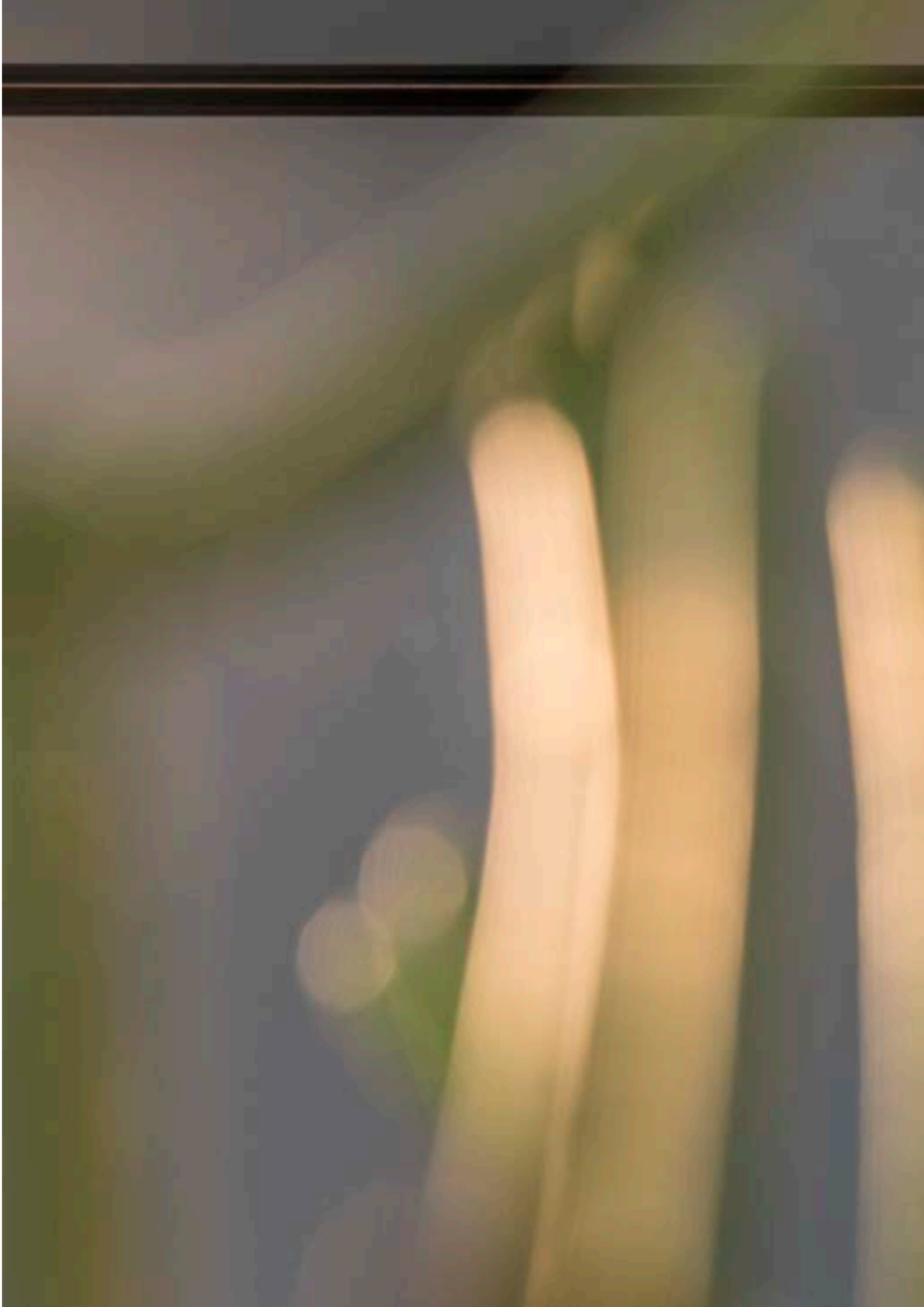







## EGO Track Flat





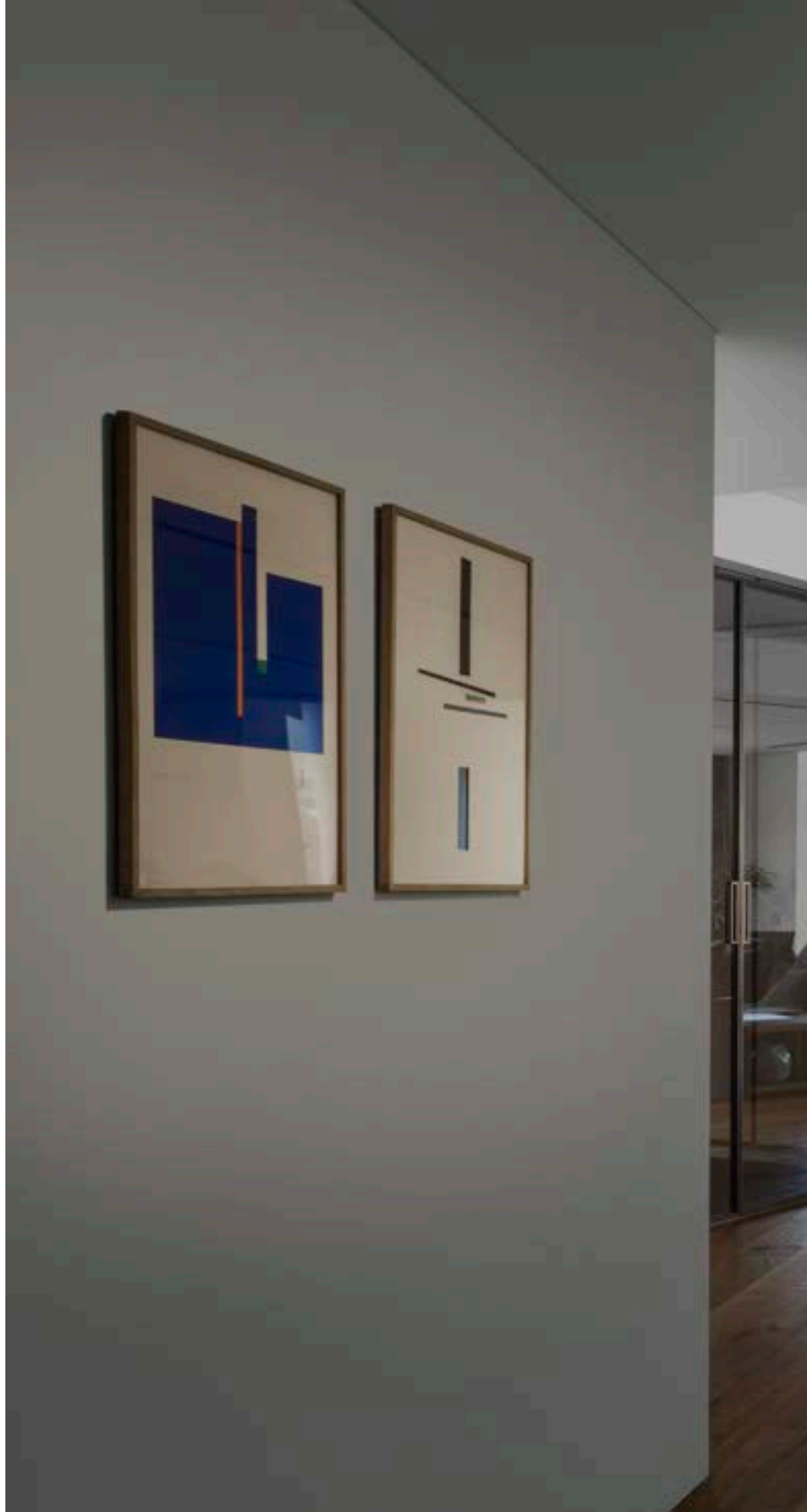





## EGO Wide















## EOS

Proiettore cilindrico in alluminio estruso con fascio di apertura variabile da stretto ad ampio (20°-55°), adatto per installazione su binario monofase o trifase LINK. Verniciatura a polveri in bianco o nero, testata girevole 355° e orientabile fino a 90°; il driver di alimentazione è incluso e trova alloggiamento nel corpo cilindrico del proiettore stesso. Ideale per l'illuminazione di grandi ambienti dove viene richiesta ampia flessibilità e alta resa cromatica, ad esempio aree espositive, spazi museali e retail.













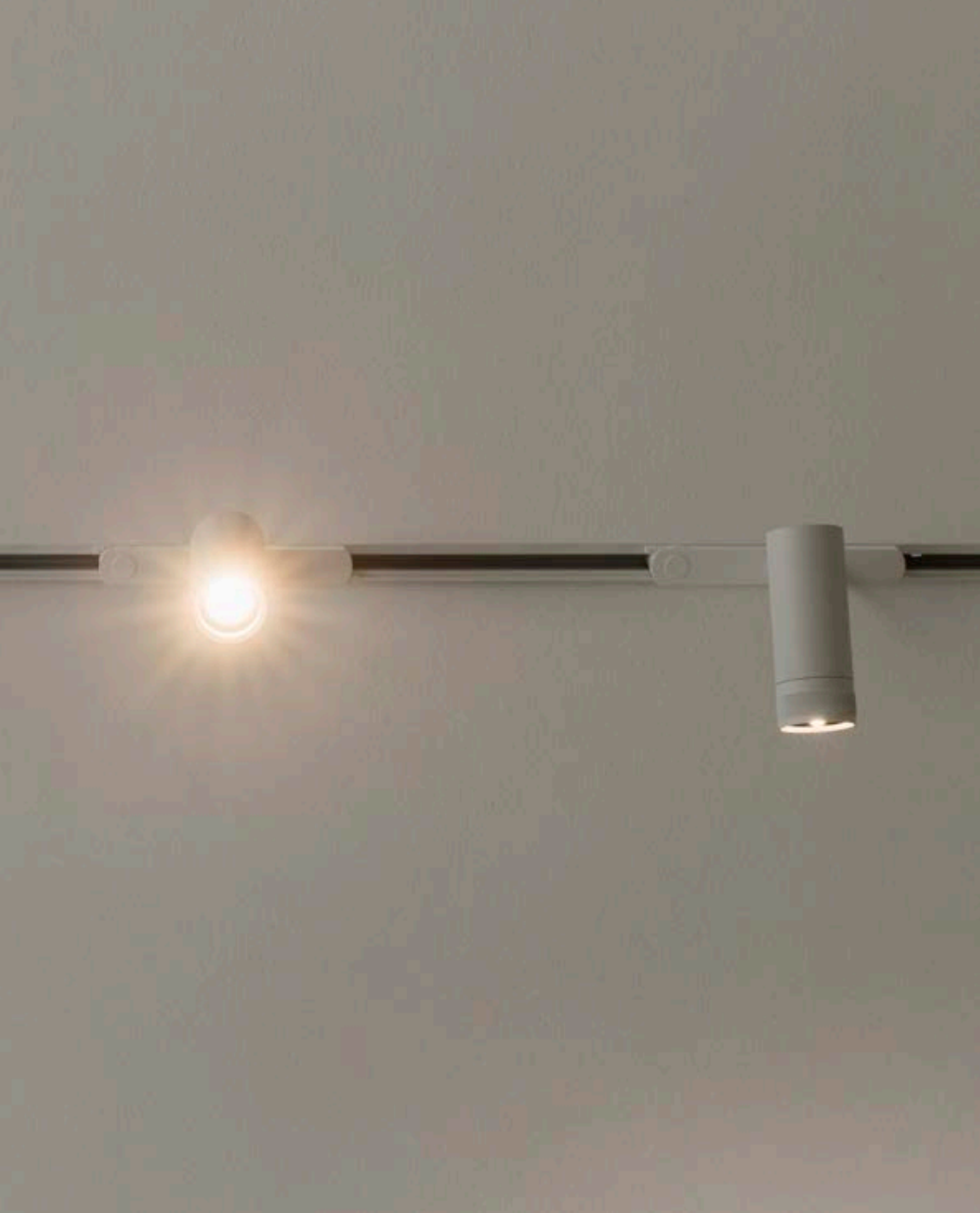







## FLUO

Sistema lineare di lampade con scocca in alluminio estruso di sezione larga 50 mm e alta 80 mm. Moduli disponibili in due lunghezze: 1200 mm e 1800 mm, componibili tra loro a seconda della disposizione desiderata. Il sistema è disponibile con due diverse configurazioni: il modello WIDE diffondente e il modello BI-EMISSION con componente luminosa per l'illuminazione indiretta.















## FOX

Proiettore cilindrico in alluminio estruso, adatto per installazione su binario monofase e trifase LINK. Verniciatura a polveri in bianco, nero oppure ottone satinato, testata girevole 350° e orientabile fino a 90°; il driver di alimentazione è incluso e trova alloggiamento nel corpo cilindrico del proiettore stesso. Ideale per l'illuminazione di piccoli e medi ambienti dove vengono richiesti ampia flessibilità di disposizione, ad esempio in spazi commerciali e retail, e un rapporto ottimale tra prestazioni e prezzo.









## LINUS

Lampada lineare in alluminio con illuminazione diretta e indiretta per applicazione a parete. La lampada è modulare e può essere proposta singolarmente oppure in linea continua. È disponibile in finitura bianca o nera.

















## QUICK

Proiettore cilindrico in alluminio estruso adatto per installazione su binario trifase. Verniciatura a polveri bianco o nero, testata girevole 355° e orientabile 90°. Il driver di alimentazione incluso, trova alloggiamento nel corpo cilindrico del proiettore stesso. Ideale per l'illuminazione di grandi ambienti dove viene richiesta ampia flessibilità e resa cromatica, ad esempio spazi museali, commerciali e retail.















## TESI

Nastro flessibile in acciaio per applicazione in tensione da parete a parete, da utilizzare come supporto per l'applicazione di strip LED per illuminazione indiretta. Nastro disponibile in due larghezze di 8 mm e 20 mm, lunghezza massima di 5 o 10 metri sezionabile su misura, supporti in alluminio con sistema di bloccaggio, disponibile nelle finiture acciaio, bianco oppure nero. Ideale per ambienti dal carattere storico e architettonico già fortemente personalizzati, con la sua sezione minimale scompare all'interno dell'ambiente per garantire un risultato di estrema pulizia formale.







**TESI**

SISTEMI, PROIETTORI E BINARI

INTERNI

IDEAL LUX

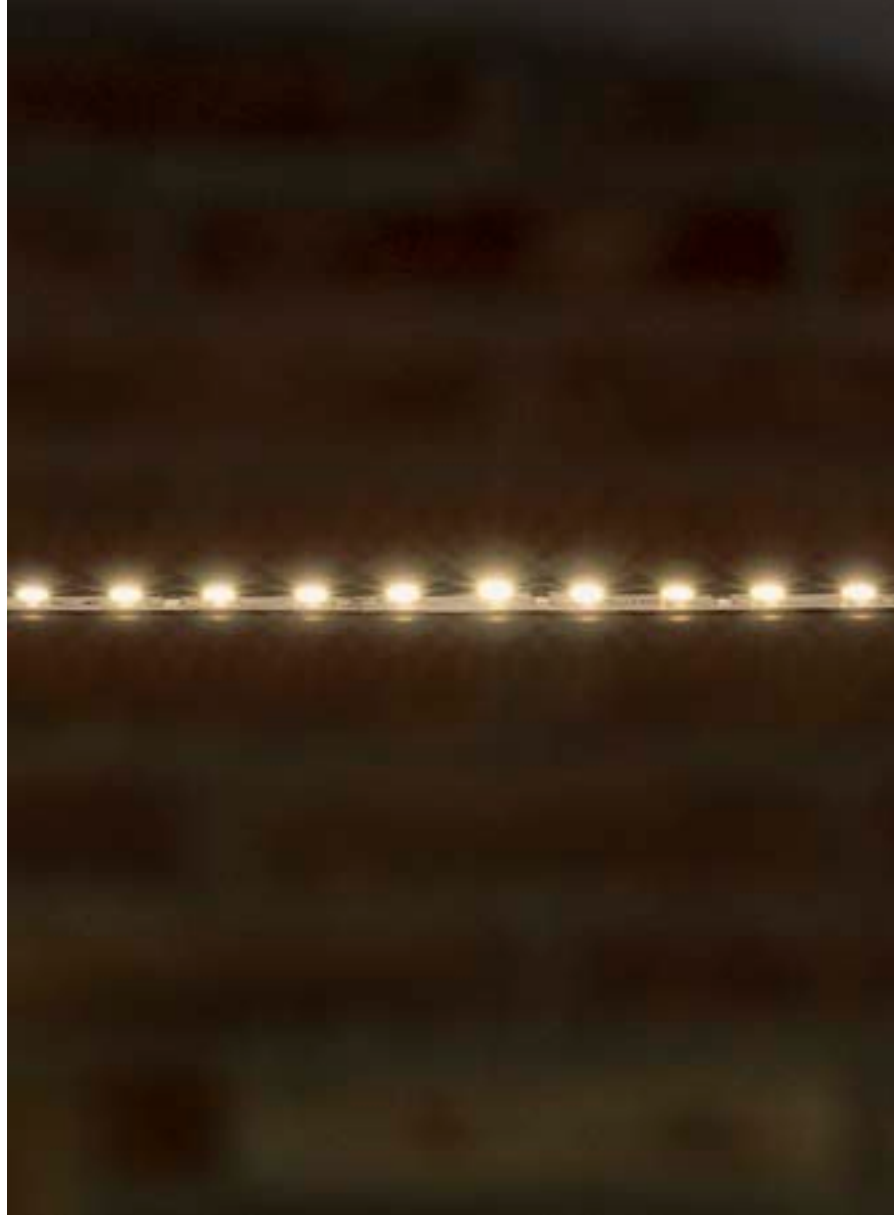



## LAMPADE DA INCASSO

TENDE TIRATE,  
LAMPADE  
CHE SI SPENGONO,  
MATTINO  
CHE VIBRA,  
GIARDINO  
CHE DÀ PACE.  
SVEGLIARSI  
IN ARMONIA,  
BRINA CHE  
SI DISSOLVE,  
QUIETE  
CHE ABBRACCIA,  
NELL'ALBA  
CHE SI POSA.





Indice

↳

342 **Game**  
348 **Lika**  
352 **Nova**  
358 **Virus**  
362 **Zeus**



## GAME

Faretto ad incasso in alluminio pressofuso con ghiera rotonda o quadrata, adatto per installazione su soffitti in cartongesso o a pannelli. Finitura argento opaca, bianca opaca RAL 9001, nera opaca RAL 9011, oro opaca RAL 1032. Disponibile in versione con cornice esterna (TRIM), a scomparsa senza cornice per cartongesso (TRIMLESS), oppure con cornice e protezione frontale migliorata (IP65).

















## LIKA

Proiettore ad incasso rettangolare in alluminio pressofuso verniciato, con sorgenti luminose arretrate, disponibile nelle versioni TRIM con bordo e TRIMLESS senza bordo, con riflettore in policarbonato nero lucido, e SLIM con dimensioni ridotte.











## NOVA

Proiettore ad incasso in alluminio pressofuso con ghiera rotonda, adatto per installazione su controsoffitti in cartongesso. Sorgente orientabile a 360° ed estraibile fino a 90° rispetto all'asse verticale. Finitura bianca opaca o nera opaca







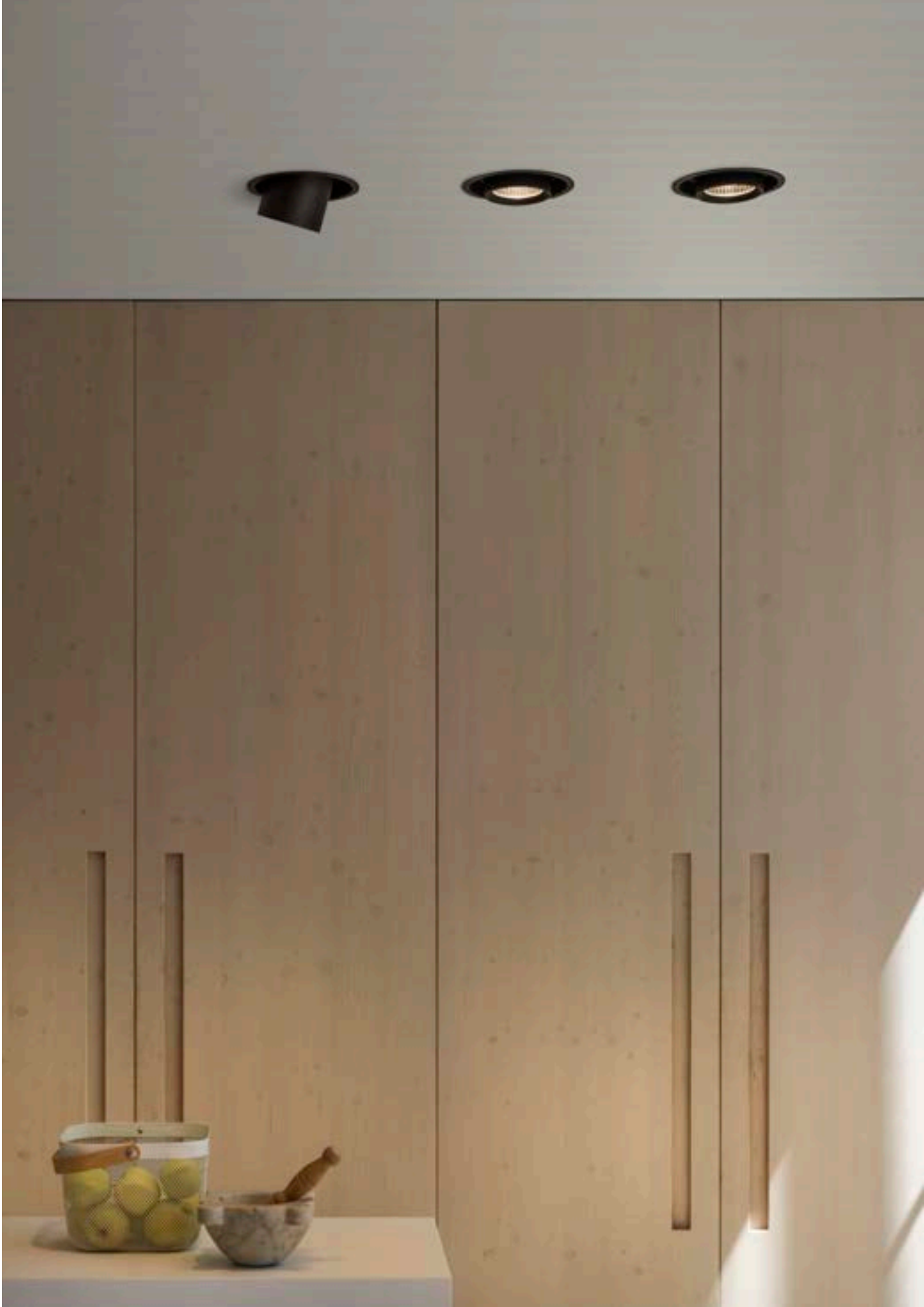





## VIRUS

Mini-faretto a incasso in alluminio con ghiera rotonda, adatto per installazione su soffitti in cartongesso o a pannelli. Finitura bianca opaca, nera opaca, oro opaco. Tecnologia LED SMD; disponibile in temperatura di colore 3000 K; CRI  $\geq$  90; protezione IP20; classe isolamento II; durata utile LED 30.000 h L70B50. L'elevata resa cromatica e le dimensioni ridotte lo rendono ideale per l'illuminazione di accento in nicchie e vetrine negli ambienti interni domestici e retail.













## ZEUS

Sistema componibile di elementi ad incasso costituito da sorgente orientabile, riflettore e ghiera rotonda o quadrata, con lenti e accessori schermanti in opzione; finitura bianca e nera; ghiera disponibile in versione TRIM con cornice o TRIMLESS senza cornice per installazione in controsoffitti in cartongesso; due diversi angoli di emissione a scelta.













## LAMPADE DA ESTERNO

PROFUMO  
DI FIORI  
CHE SI SPECCHIANO  
IN PISCINA,  
IL SOLE  
CHE SI RITIRA,  
IL GIARDINO  
CHE S'ILLUMINA.  
LUCI DANZANTI,  
PREPARANO  
LA SCENA  
DELLA SERA.  
BICCHIERI  
CHE TINTINNO,  
PREPARANDOSI  
PER LA CENA.

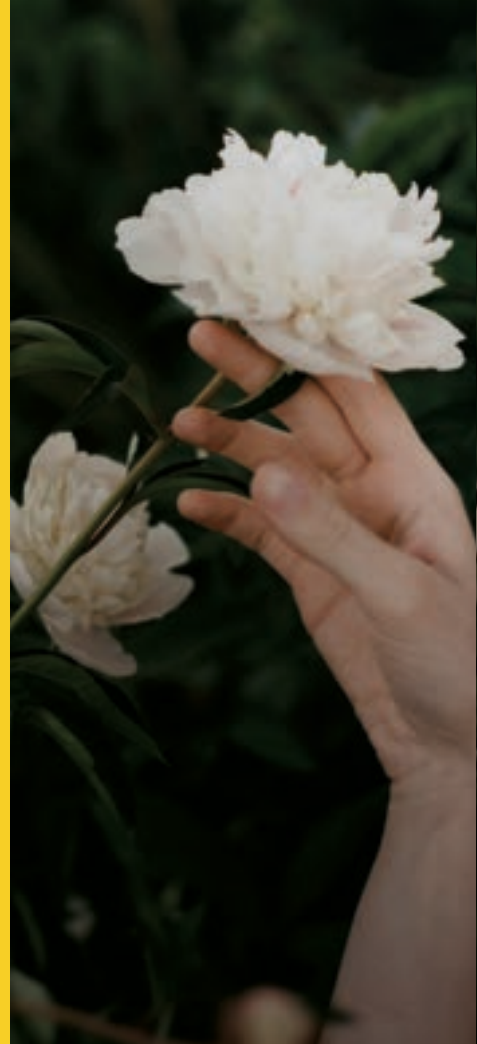



Indice

↳

370 **Agos**  
378 **Andromeda**  
382 **Atom**  
388 **Gun**  
396 **Jedi**  
402 **Linea**  
406 **Lolita**  
414 **Punto**  
418 **Pure**  
422 **Sirio**

430 **Sole**  
436 **Starlight**  
442 **Style**  
448 **Swipe**  
454 **Taurus**  
460 **Techo**  
466 **Tesla**  
472 **Vega**



## AGOS

Corpo luce in alluminio pressofuso verniciato a polveri. Diffusore in acrilico trasparente satinato. Colori: antracite o coffee.





LAMPADE DA TERRA ESTERNI IDEAL LUX

















## ANDROMEDA

Corpo luce in alluminio pressofuso verniciato. Doppio diffusore, superiore e inferiore, in vetro pirex satinato. Disponibile nelle finiture antracite, bianco, coffee, grigio o nero.









## ATOM

Corpo luce in alluminio verniciato a polveri. Diffusori in vetro. Doppio fascio luminoso, sopra e sotto, ad ampiezza regolabile con alette mobili.

















## GUN

Corpo luce in alluminio con finitura naturale spazzolata o in vernice con varie finiture. Diffusore in vetro pirex trasparente. Emissione luce sopra e sotto.





















## JEDI

Base e corpo luce in alluminio verniciato a polveri. Diffusore in policarbonato opale lucido. Fornito con picchetto per installazione su terreno. Finiture: antracite oppure nero.







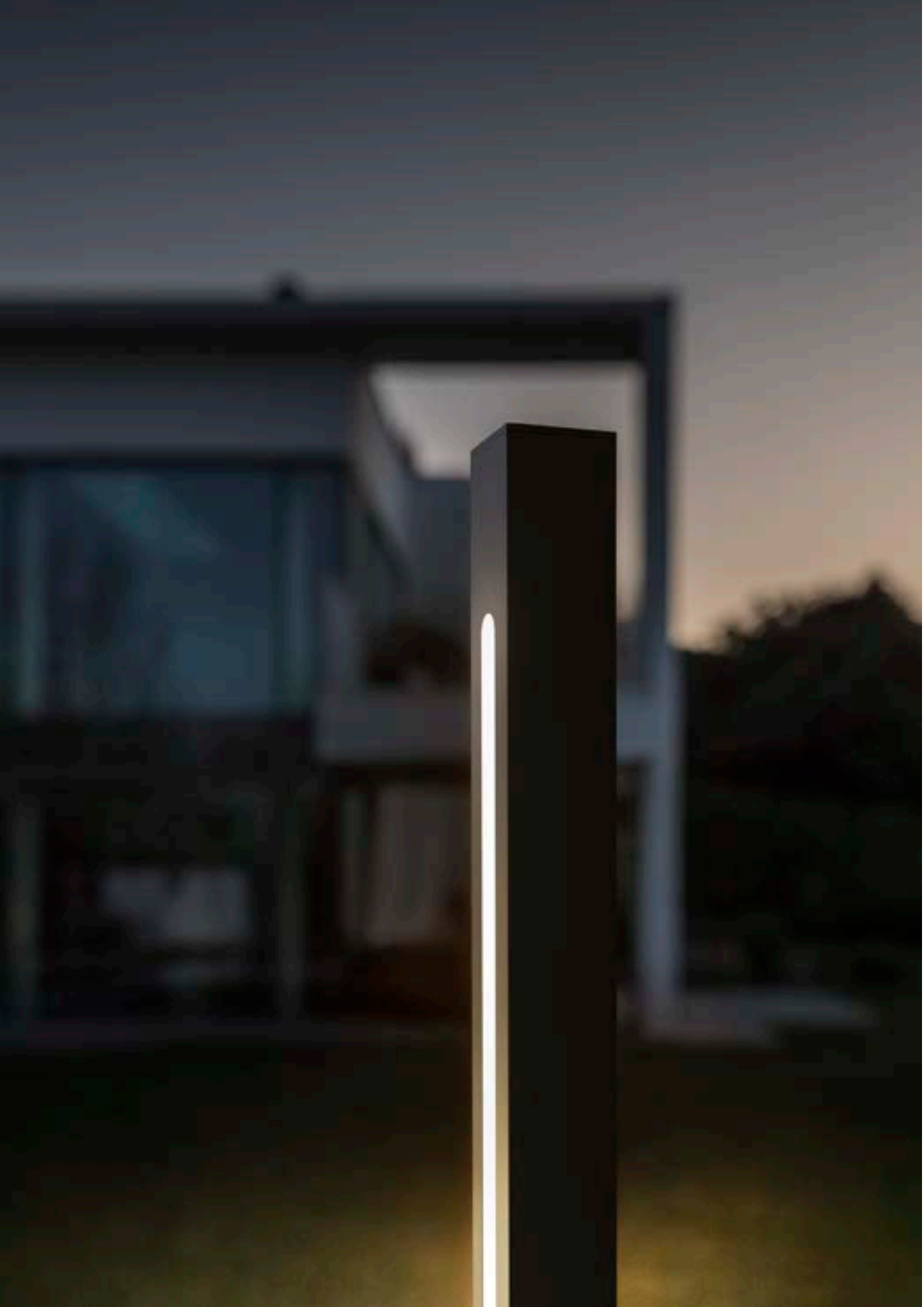

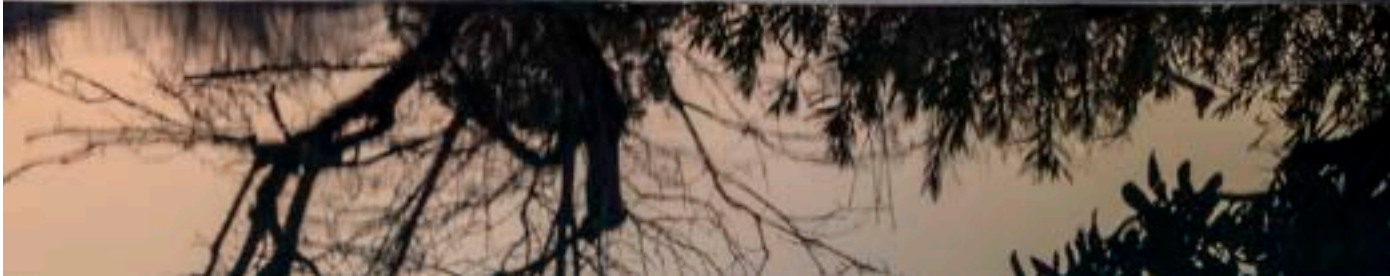





## LINEA

Base e corpo luce in alluminio verniciato a polveri. Diffusori in vetro. Emissione luce indiretta. Finiture: antracite, bianco, coffee, nero.











## LOLITA

Lampada da tavolo a batteria ricaricabile con finitura bianca, grigia, nera o coffee. Base in plastica. Montatura in metallo. Diffusore in materiale plastico. Autonomia di 14 ore. Tempo di ricarica della batteria 7 ore.







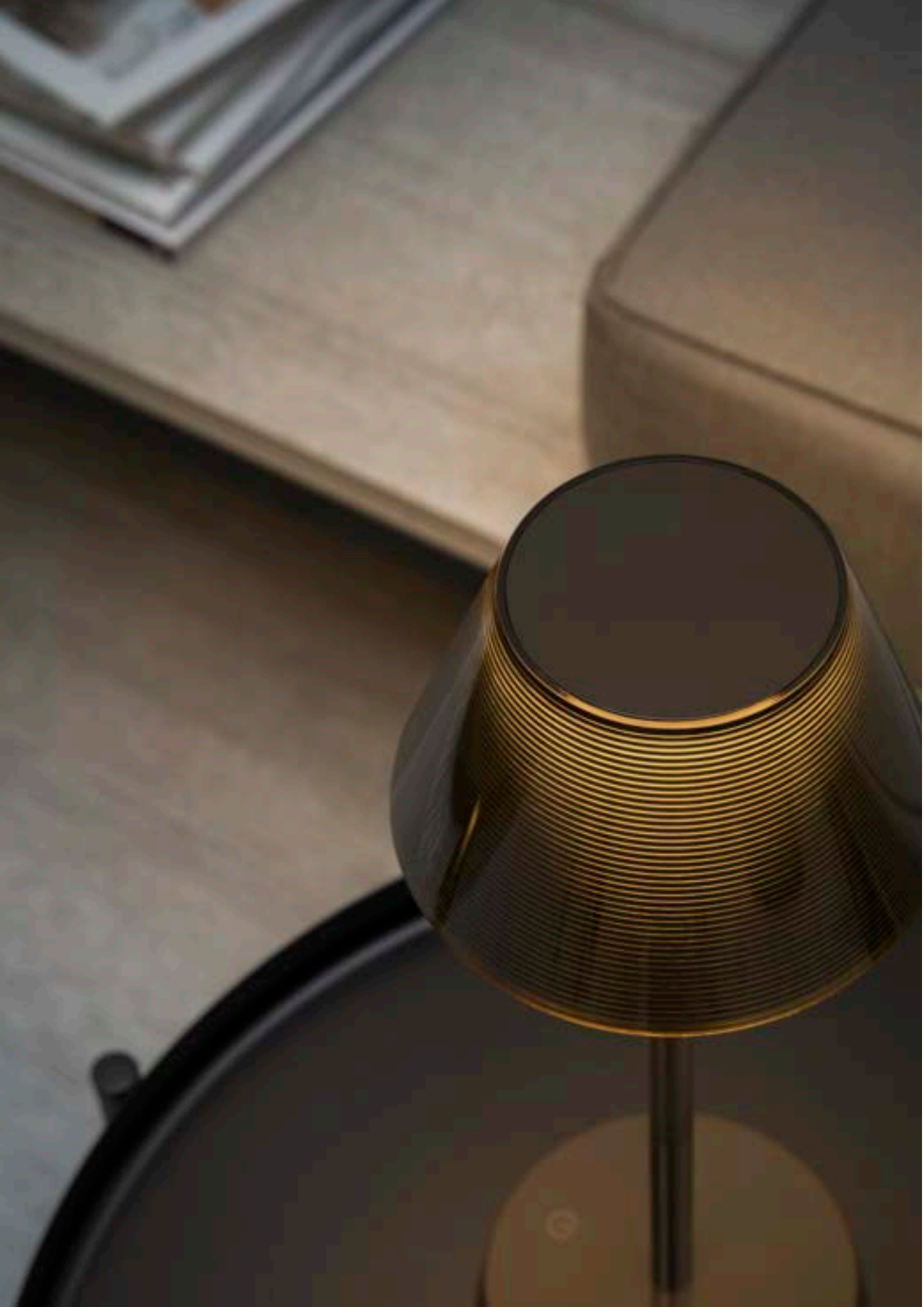

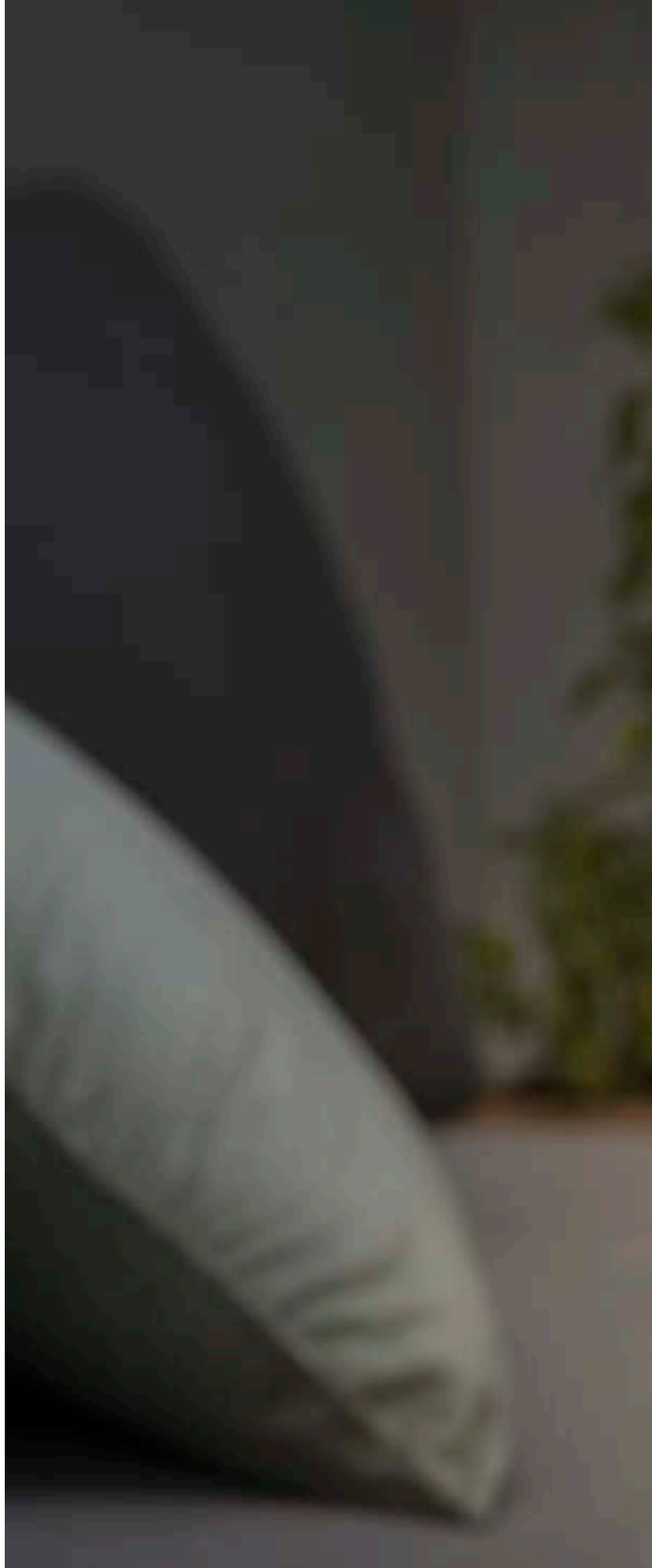









## PUNTO

Base e corpo luce in alluminio verniciato a polveri. Diffusori in vetro. Emissione luce indiretta. Finiture: antracite, bianco, coffee, nero.













## PURE

Base, stelo e paralume in metallo verniciato opaco. Diffusore in acrilico. Batteria ricaricabile e interruttore touch integrato. Finiture: bianco, coffee, nero. Tempo di ricarica della batteria 6 ore.









## SIRIO

Corpo luce in alluminio verniciato a polveri. Diffusore in vetro pirex trasparente. Disponibile nelle finiture antracite, bianco, coffee, grigio o nero.











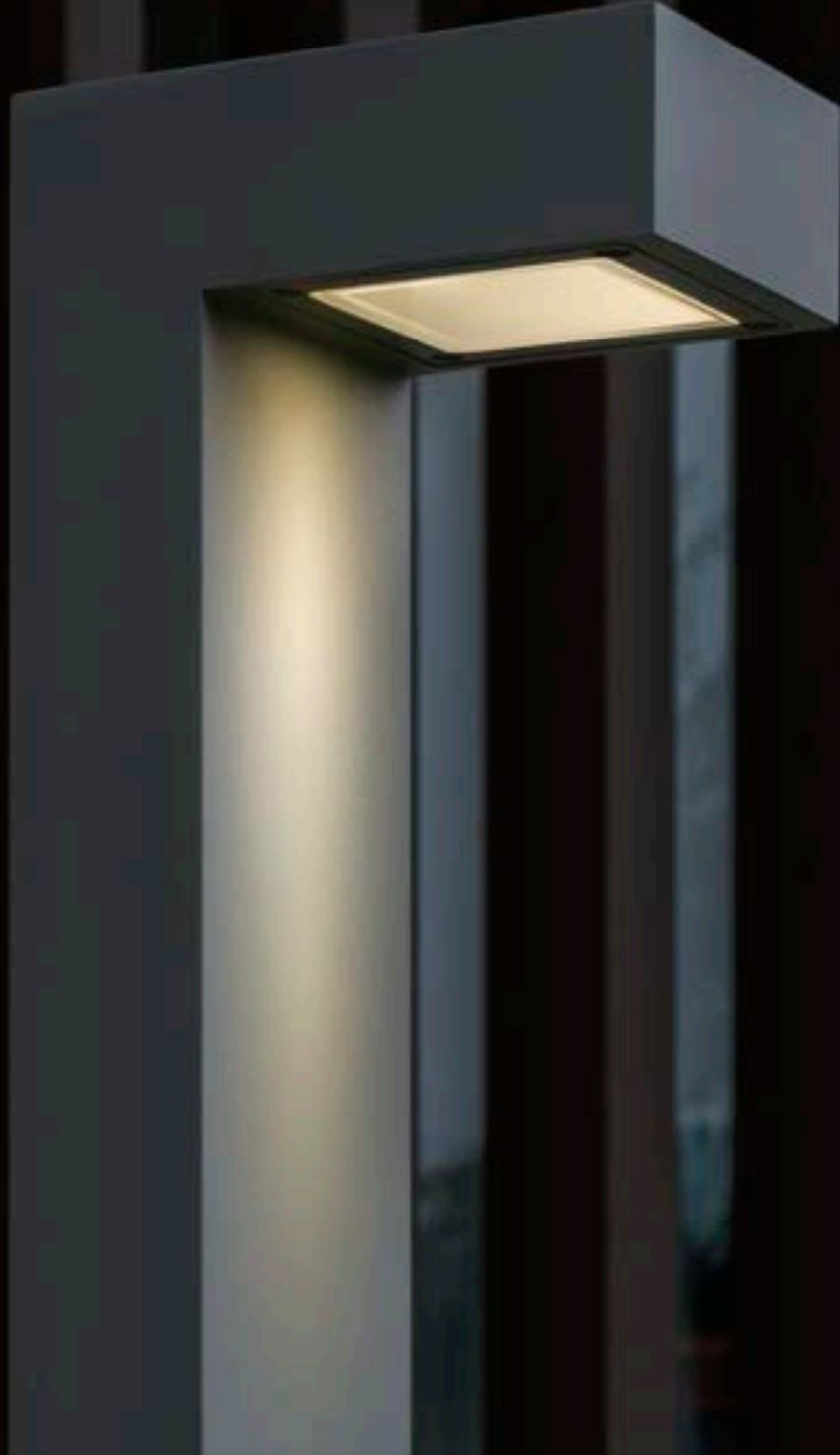









## SOLE

Diffusore in materiale plastico opale. Fornito con spina e picchetto per terreno.









LAMPADE DA TERRA

ESTERNI

IDEAL LUX







## STARLIGHT

Proiettore orientabile in alluminio con fissaggio a plafone o con picchetto; superficie anodizzata e verniciata a polveri in grigio scuro; LED integrato ad efficienza energetica con elevata resa cromatica; disponibile in temperatura di colore 3000K e 4000K; durata utile LED 50.000 h. Visiera antiabbagliamento in opzione.















## STYLE

Corpo luce in alluminio verniciato a polveri. Diffusore in materiale plastico opale. Sorgente luminosa a led integrato. Disponibile nelle finiture antracite, bianco, coffee, grigio o nero.

















## SWIPE

Corpo luce in alluminio verniciato a polveri. Diffusore orientabile con schermo in policarbonato opale lucido. Disponibile con sensore crepuscolare e di movimento. Finiture: antracite, bianco, grigio, coffee oppure nero.



LAMPADE DA PARETE ESTERNI IDEAL LUX

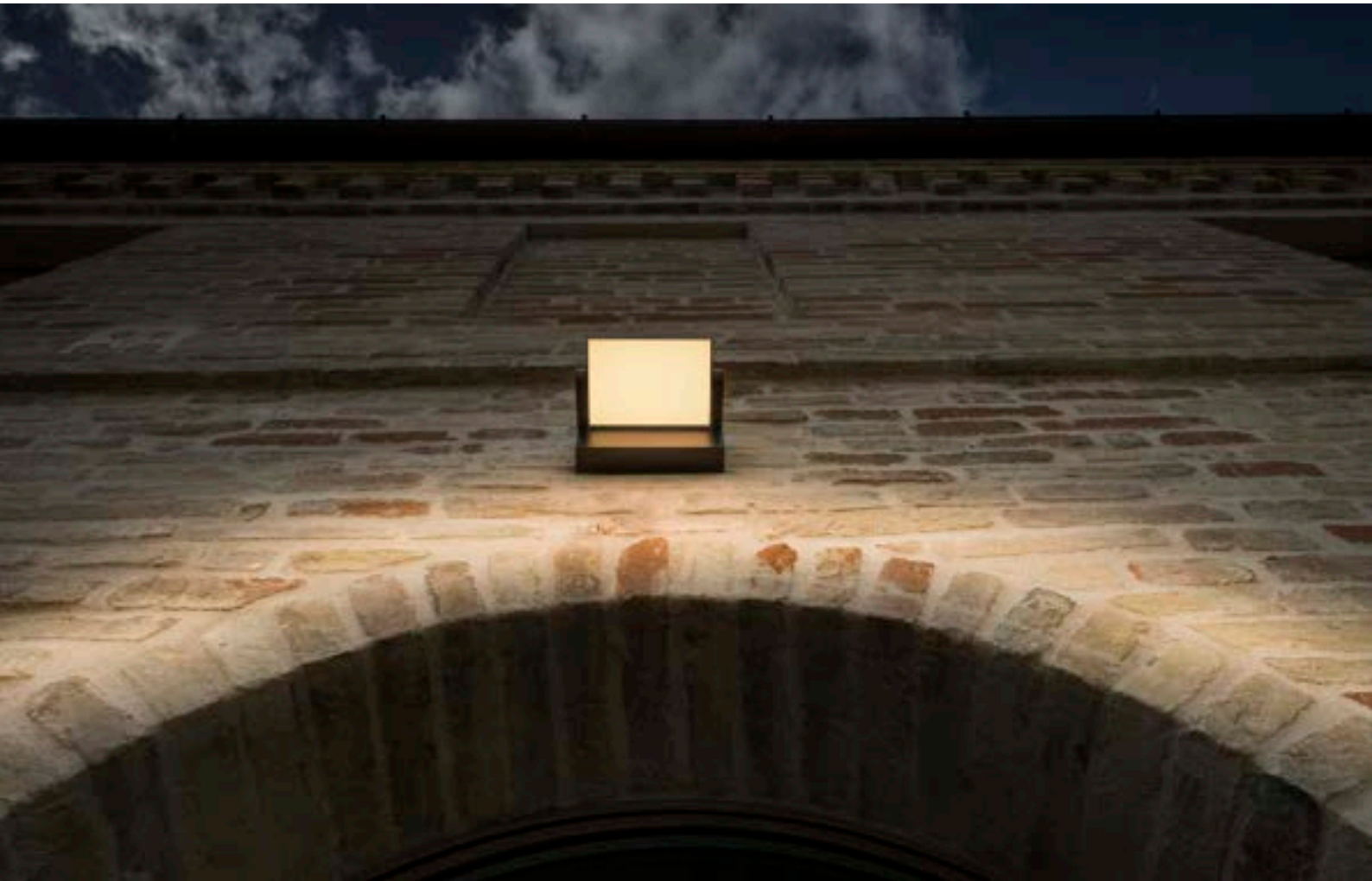









## TAURUS

Proiettore da incasso per installazione a pavimento, parete o soffitto. Corpo in alluminio pressofuso, ghiera in acciaio inox 316L, diffusore in vetro, calpestabile (IP67, IK10), cassaforma inclusa. Moduli luminosi singolarmente orientabili di +/- 30° mediante perno esterno per restringere o direzionare il fascio luminoso.















## TECHO

Corpo luce in alluminio pressofuso verniciato a polveri. Diffusore in vetro temperato trasparente smerigliato. Colori: antracite, bianco, coffee o nero.

















## TESLA

Corpo luce in alluminio verniciato a polveri. Diffusore con schermo in materiale plastico bianco. Emissione luce verso il basso. Disponibile nelle finiture antracite, bianco, coffee, nero.

















## VEGA

Corpo luce in alluminio con finitura in vernice opaca a polveri. Diffusore in vetro temperato trasparente. Disponibile nelle finiture antracite, bianco, coffee, grigio o nero.













# ELENCO FINITURE





TRASPARENTE



BIANCO



CROMO SFUMATO



ACCIAIO



ARGENTO



CROMO



ALLUMINIO



GRIGIO



NICKEL



FUMÈ

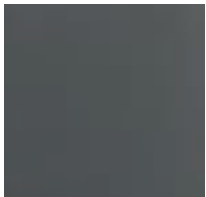

ANTRACITE

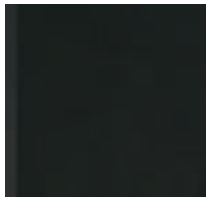

NERO



AMBRA



BEIGE



TORTORA



ORO

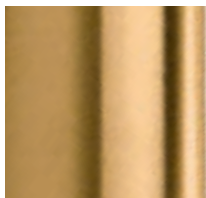

OTTONE

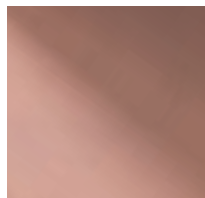

RAME



COFFEE



BRUNITO

NOTE: Le finiture rappresentate hanno scopo illustrativo. Le tonalità sono soggette a variazioni dettate dal tipo di materiale impiegato e dalla sua lavorazione che possono alterarne la resa,

di conseguenza articoli catalogati con medesima finitura potranno presentare delle differenze nella percezione del colore.



SCHEDE TECNICHE

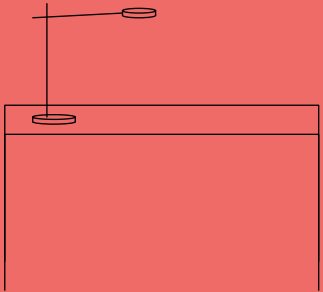
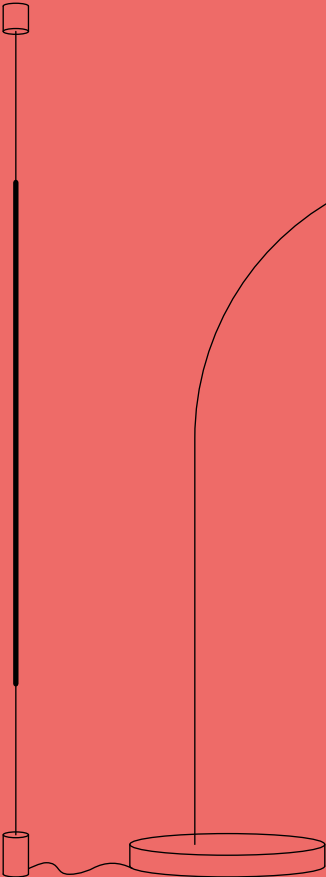
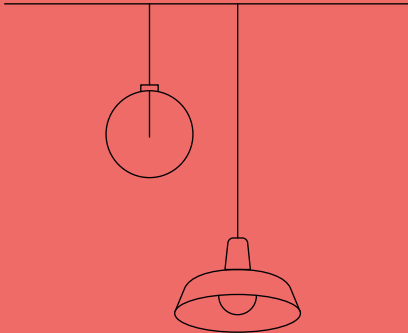
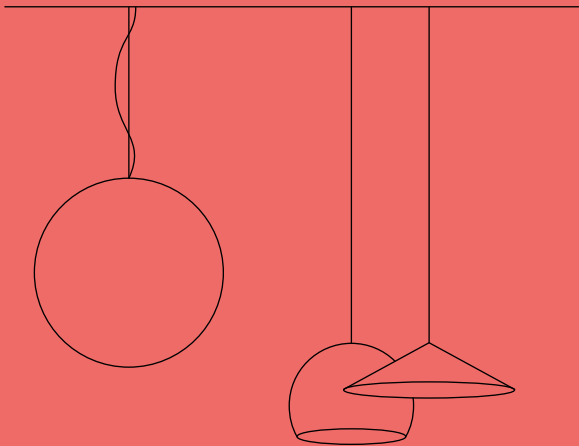

# SCHEDE TECNICHE INTERNI

Lampade decorative:  
indice alfabetico per icone

↳

BEAN



488

EGO



495

BINOMIO



488

EQUINOXE



496

BIRDS



489

ESSENCE



498

CLIP

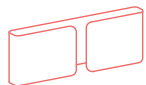

491

FILO



499

COVER



492

FLY



502

DELTA



493

FOCUS

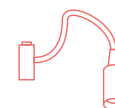

506

DIESIS



493

FRAME

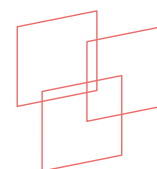

506

DORSALE

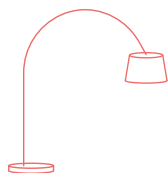

494

FUTURA

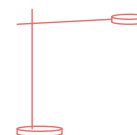

508

DYNAMITE

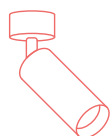

495

GEMINI

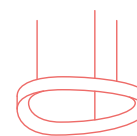

508

LOOK



510

OZ



524

MAPA



512

PERLAGE



525

MINT



515

PIANO

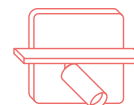

528

MIX UP

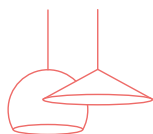

515

SET UP



528

MOBY



516

SMARTIES



532

NEMO



517

SPIKE



533

NINFEA



518

ULTRATHIN



534

NITRO



519

ZIG ZAG



535

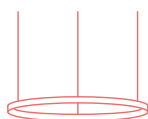

ORACLE SLIM



521

Lampade tecniche:  
indice alfabetico per icone



			LIKA		585
DEVA		536	LINK		588
DISPLAY		548	LINUS		600
EGO		551	NOVA		601
EOS		573	QUICK		602
FLUO		574	TESI		605
FOX		578	VIRUS		606
GAME		581	ZEUS		608

# SCHEDE TECNICHE ESTERNI

Lampade per esterni:  
indice alfabetico per icone

↳



AGOS



610

SIRIO

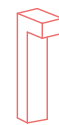

614

ANDROMEDA

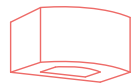

610

SOLE



615

ATOM



611

STARLIGHT



617

GUN

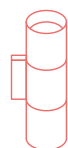

611

STYLE



618

JEDI



612

SWIPE

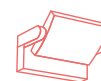

619

LINEA



612

TAURUS



620

LOLITA



613

TECHO



621

PUNTO



613

TESLA



622

PURE



614

VEGA



622

# BEAN

DA PARETE



IP20



FOTO p. 144

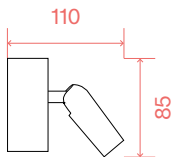

FINITURA	CODICE	€
Bianco	260648	55
Nickel	260679	55
Nero	260655	55
Ottone	260662	55

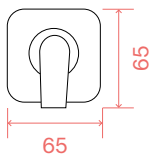

Sorgente luminosa LED  
3000 K, 30.000 h di durata.



0,180 Kg  
0,0008 m<sup>3</sup>  
LED 3W / 260 lm

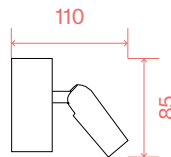

FINITURA	CODICE	€
Bianco	260600	55
Nickel	260631	55
Nero	260617	55
Ottone	260624	55

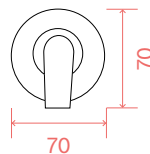

Sorgente luminosa LED  
3000 K, 30.000 h di durata.



0,180 Kg  
0,0005 m<sup>3</sup>  
LED 3W / 260 lm

# BINOMIO

DA PARETE



IP20



FOTO p. 148

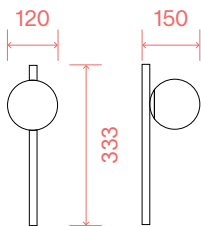

(CONSIGLIATA)

LUMEN	CCT	CODICE	€
510 lm	3000 K	305486	6

FINITURA	CODICE	€
Bianco	328478	55
Nero	310664	55
Ottone	311319	55

Lampadine LED G9 3W 3000 K  
includ. Cod. 209043

0,5000 Kg  
0,0081 m<sup>3</sup>  
G9 max 1 x 4W

# BINOMIO

DA PARETE / SOFFITTO  IP20

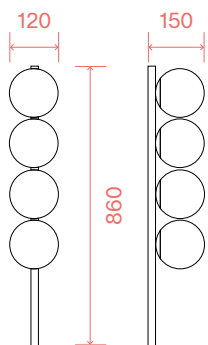

(CONSIGLIATA)

LUMEN	CCT	CODICE	€
510 lm	3000 K	305486	6

FINITURA	CODICE	€
Bianco	328454	130
Nero	310688	130
Ottone	328461	130

 Lampadine LED G9 3W 3000 K include. Cod. 209043

1,550 Kg  
0,0240 m<sup>3</sup>  
G9 max 4 x 4W

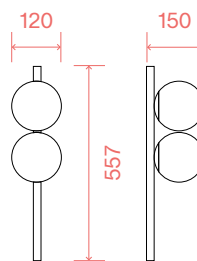

(CONSIGLIATA)

LUMEN	CCT	CODICE	€
510 lm	3000 K	305486	6

FINITURA	CODICE	€
Bianco	328430	90
Nero	310671	90
Ottone	328447	90

 Lampadine LED G9 3W 3000 K include. Cod. 209043

1,200 Kg  
0,0145 m<sup>3</sup>  
G9 max 2 x 4W

# BIRDS

SOSPENSIONE  IP20

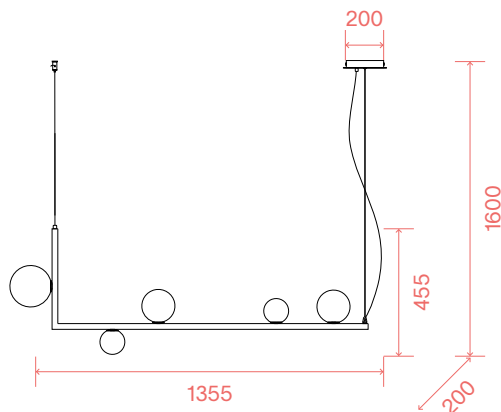

(CONSIGLIATA)

LUMEN	CCT	CODICE	€
510 lm	3000 K	305486	6

FINITURA	CODICE	€
Nero	273648	283

 Lampadine LED G9 3W 3000 K include. Cod. 209043

2,750 Kg  
0,1353 m<sup>3</sup>  
G9 max 5 x 15W

# BIRDS

DA SOFFITTO



IP20



FOTO p. 114

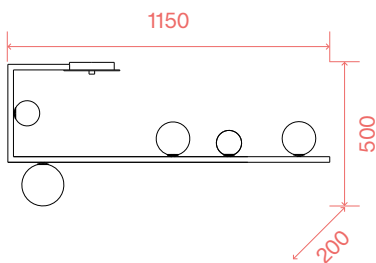

2,800 Kg  
0,1535 m<sup>3</sup>  
G9 max 5 x 15W

(CONSIGLIATA)

LUMEN	CCT	CODICE	€
510 lm	3000 K	305486	6

FINITURA	CODICE	€
Nero	273631	278

Lampadine LED G9 3W 3000 K  
includ. Cod. 209043

DA PARETE



IP20

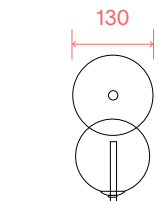
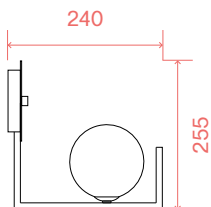

0,670 Kg  
0,0192 m<sup>3</sup>  
G9 max 1 x 15W

(CONSIGLIATA)

LUMEN	CCT	CODICE	€
510 lm	3000 K	305486	6

FINITURA	CODICE	€
Nero	273655	73

Lampadine LED G9 3W 3000 K  
includ. Cod. 209043

DA TAVOLO



IP20

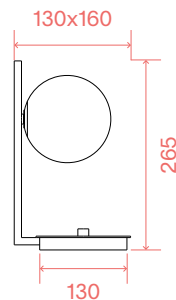

0,900 Kg  
0,0163 m<sup>3</sup>  
G9 max 1 x 15W

(CONSIGLIATA)

LUMEN	CCT	CODICE	€
510 lm	3000 K	305486	6

FINITURA	CODICE	€
Nero	273679	86

Lampadine LED G9 3W 3000 K  
includ. Cod. 209043



# BIRDS

DA TERRA

 IP20  **FOTO** p. 228

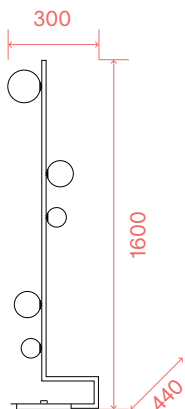

(CONSIGLIATA)

LUMEN	CCT	CODICE	€
510 lm	3000 K	305486	6

FINITURA	CODICE	€
Nero	273662	340



 Lampadine LED G9 3W 3000 K incluse. Cod. 209043



5,640 Kg  
0,1536 m<sup>3</sup>  
G9 max 5 x 15W

# CLIP

DA PARETE

 IP20  **FOTO** p. 152

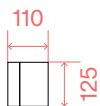
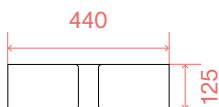

(CONSIGLIATA)

LUMEN	CCT	CODICE	€
430 lm	3000 K	101279	2

FINITURA	CODICE	€
Bianco	014166	107
Argento	088273	107
Cromo	031361	107
Oro	088266	107
Coffee	187365	107

1,210 Kg  
0,0161 m<sup>3</sup>  
E27 max 2 x 60W

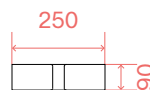

(CONSIGLIATA)

LUMEN	CCT	CODICE	€
510 lm	3000 K	305486	6

FINITURA	CODICE	€
Bianco	049236	95
Argento	091136	95
Cromo	049229	95
Oro	091129	95
Coffee	170923	95

0,680 Kg  
0,0035 m<sup>3</sup>  
G9 max 2 x 40W

 Lampadine LED G9 3W 3000 K incluse. Cod. 209043

# COVER

DA PARETE / SOFFITTO  IP20  FOTO p. 156

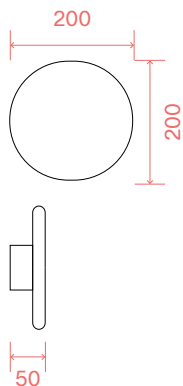

FINITURA	CODICE	€
Bianco	195711	100
Nero	195759	100

 Sorgente luminosa LED  
3000 K, 30.000 h di durata.

0,690 Kg  
0,0028 m<sup>3</sup>  
LED 11W / 1100 lm

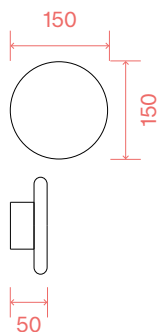

FINITURA	CODICE	€
Bianco	195704	88
Nero	195742	88

 Sorgente luminosa LED  
3000 K, 30.000 h di durata.

0,390 Kg  
0,0018 m<sup>3</sup>  
LED 9,5W / 730 lm

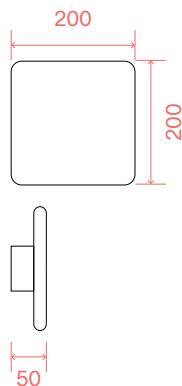

FINITURA	CODICE	€
Bianco	195735	100
Nero	195773	100

 Sorgente luminosa LED  
3000 K, 30.000 h di durata.

0,860 Kg  
0,0028 m<sup>3</sup>  
LED 11W / 1100 lm

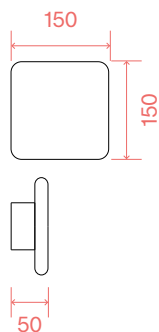

FINITURA	CODICE	€
Bianco	195728	88
Nero	195766	88

 Sorgente luminosa LED  
3000 K, 30.000 h di durata.

0,510 Kg  
0,0018 m<sup>3</sup>  
LED 9,5W / 730 lm

# DELTA

DA PARETE  IP20  FOTO p. 162

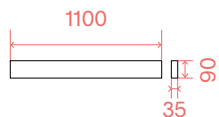

FINITURA	CCT	CODICE	€
Bianco	3000 K	287607	185
Bianco	4000 K	307053	185
Nero	3000 K	287591	185
Nero	4000 K	307060	185

 Sorgente luminosa LED  
3000/4000 K, 35.000 h  
di durata.

2,400 Kg  
0,0102 m<sup>3</sup>  
LED 37W  
4300/4550 lm

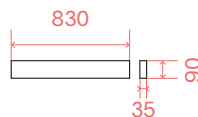

FINITURA	CCT	CODICE	€
Bianco	3000 K	287621	160
Bianco	4000 K	307039	160
Nero	3000 K	287614	160
Nero	4000 K	307046	160

 Sorgente luminosa LED  
3000/4000 K, 35.000 h  
di durata.

0,900 Kg  
0,0078 m<sup>3</sup>  
LED 30W  
3350/3500 lm

# DELTA

DA PARETE



IP20



FOTO p. 162

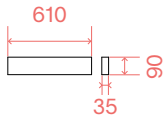

0,950 Kg  
0,0058 m<sup>3</sup>  
LED 19,5W  
2200/2250 lm

FINITURA	CCT	CODICE	€
Bianco	3000 K	287645	110
Bianco	4000 K	307015	110
Nero	3000 K	287638	110
Nero	4000 K	307022	110

Sorgente luminosa LED  
3000/4000 K,  
35.000 h di durata.

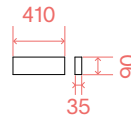

0,580 Kg  
0,0042 m<sup>3</sup>  
LED 14W  
1550/1650 lm

FINITURA	CCT	CODICE	€
Bianco	3000 K	316789	81
Bianco	4000 K	345192	81
Nero	3000 K	345185	81
Nero	4000 K	345208	81

Sorgente luminosa LED  
3000/4000 K,  
35.000 h di durata.

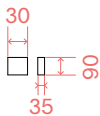

0,450 Kg  
0,0030 m<sup>3</sup>  
LED 10W  
1700/1800 lm

FINITURA	CCT	CODICE	€
Bianco	3000 K	345154	64
Bianco	4000 K	345161	64
Nero	3000 K	336510	64
Nero	4000 K	345178	64

Sorgente luminosa LED  
3000/4000 K,  
35.000 h di durata.

# DIESIS

SOSPENSIONE



IP20

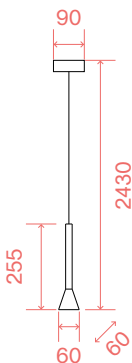

0,450 Kg  
0,0054 m<sup>3</sup>  
LED 7W / 500 lm

FINITURA	CODICE	€
Nickel	285122	110
Nero	279770	110
Ottone	279794	110

Sorgente luminosa LED  
3000 K, 20.000 h di durata.

DA TAVOLO



IP20

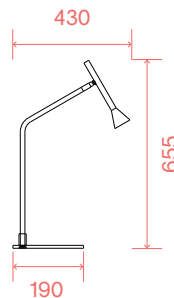

1,700 Kg  
0,0637 m<sup>3</sup>  
LED 6,5W / 500 lm

FINITURA	CODICE	€
Nickel	291093	150
Nero	283333	150
Ottone	291109	150

Sorgente luminosa LED  
3000 K, 30.000 h di durata.



# DIESIS

DA TERRA



IP20



FOTO p. 234

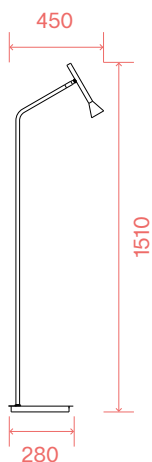

FINITURA	CODICE	€
Nickel	285337	180
Nero	279800	180
Ottone	285344	180

 Sorgente luminosa LED  
3000 K, 20.000 h di durata.



3,500 Kg  
0,0222 m<sup>3</sup>  
LED 4,5W / 280 lm

# DORSALE

DA TERRA



IP20



FOTO p. 242

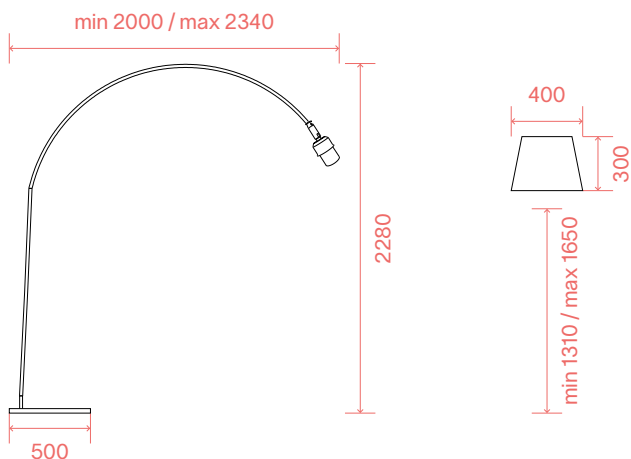

12,000 Kg  
0,0856 m<sup>3</sup>  
E27 max 1 x 60W

0,430 Kg  
0,0709 m<sup>3</sup>

(CONSIGLIATA)

LUMEN	CCT	CODICE	€
1050 lm	3000 K	101347	6

FINITURA	CODICE	€
Bianco	286686	600
Cromo	286662	600
Nero	286679	600



PARALUME

FINITURA	CODICE	€
Bianco	046723	75
Cromo	041742	75
Nero	046471	75



# DYNAMITE

SOSPENSIONE



IP20

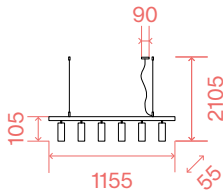

(CONSIGLIATA)

LUMEN	CCT	CODICE	€
540 lm	3000 K	123943	3,50

FINITURA	CODICE	€
Bianco	231433	350
Nero	231396	350
Ottone	244648	350

2,700 Kg  
0,0360 m<sup>3</sup>  
GU10 max 6 x 28W

Lampadine LED GU10 7W  
3000 K incluse. Cod. 123943

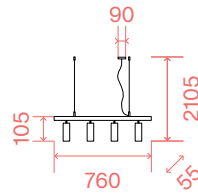

(CONSIGLIATA)

LUMEN	CCT	CODICE	€
540 lm	3000 K	123943	3,50

FINITURA	CODICE	€
Bianco	231372	275
Nero	231341	275
Ottone	244624	275

2,310 Kg  
0,0243 m<sup>3</sup>  
GU10 max 4 x 28W

Lampadine LED GU10 7W  
3000 K incluse. Cod. 123943

# EGO

DA PARETE / SOFFITTO



IP20

FOTO p. 118

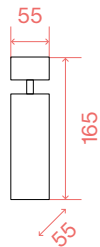

(CONSIGLIATA)

LUMEN	CCT	CODICE	€
540 lm	3000 K	123943	3,50

FINITURA	CODICE	€
Bianco	231495	98
Nero	231471	98
Ottone	244662	98

0,430 Kg  
0,0037 m<sup>3</sup>  
GU10 max 1 x 28W

Lampadine LED GU10 7W  
3000 K incluse. Cod. 123943

DA TERRA



IP20

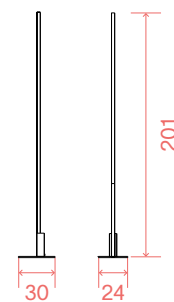

FINITURA	CODICE	€
Nero	344775	300

Sorgenti componibili con  
moduli luminosi 1-10V della  
serie Ego (max 95 W,  
lunghezza totale 1250 mm)



10,600 Kg  
0,0259 m<sup>3</sup>

# EQUINOXE

SOSPENSIONE



IP20



FOTO p. 16

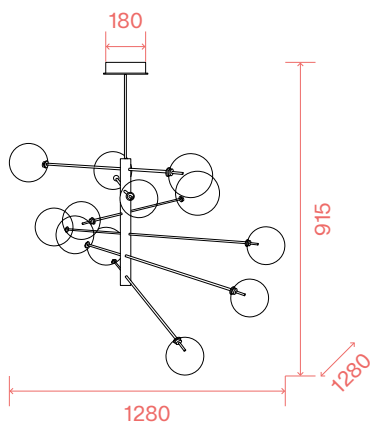

8,000 Kg  
0,1487 m<sup>3</sup>  
G4 max 12 x 2W

(CONSIGLIATA)

LUMEN	CCT	CODICE	€
200 lm	3000 K	222257	4

FINITURA	CODICE	€
Cromo	200118	1045
Ottone	200125	1045
Fumé sfum.	345390	1045
Ambra sfum.	345383	1045



Lampadine LED G4 2W 3000 K  
includ. Cod. 222257

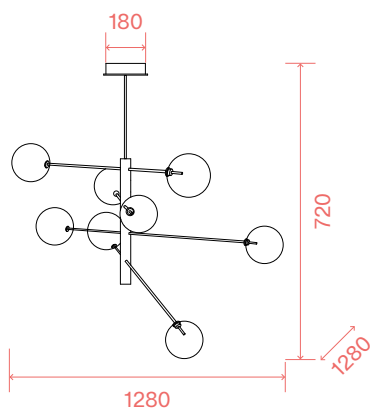

5,200Kg  
0,0938 m<sup>3</sup>  
G4 max 8 x 2W

(CONSIGLIATA)

LUMEN	CCT	CODICE	€
200 lm	3000 K	222257	4

FINITURA	CODICE	€
Cromo	275178	825
Ottone	275215	825
Fumé sfum.	345437	825
Ambra sfum.	345420	825



Lampadine LED G4 2W 3000 K  
includ. Cod. 222257

# EQUINOXE

SOSPENSIONE

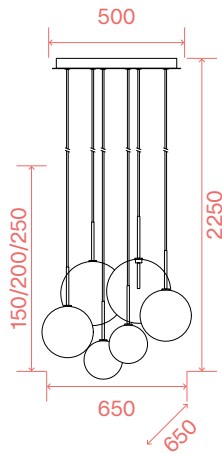

(CONSIGLIATA)

LUMEN	CCT	CODICE	€
200 lm	3000 K	222257	4

FINITURA	CODICE	€
Cromo	317250	715
Ottone	317243	715
Fumé sfum.	345413	715
Ambra sfum.	345406	715

LED Lampadine LED G4 2W 3000 K include. Cod. 222257

7,000 Kg  
0,1274 m<sup>3</sup>  
G4 max 6 x 2W

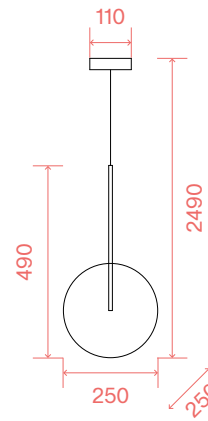

(CONSIGLIATA)

LUMEN	CCT	CODICE	€
200 lm	3000 K	222257	4

FINITURA	CODICE	€
Cromo	306551	198
Ottone	277394	198
Fumé sfum.	345376	198
Ambra sfum.	326368	198

LED Lampadine LED G4 2W 3000 K include. Cod. 222257

0,850 Kg  
0,0326 m<sup>3</sup>  
G4 max 1 x 2W

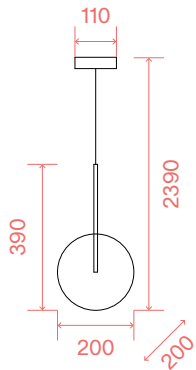

(CONSIGLIATA)

LUMEN	CCT	CODICE	€
200 lm	3000 K	222257	4

FINITURA	CODICE	€
Cromo	306544	154
Ottone	277387	154
Fumé sfum.	345369	154
Ambra sfum.	345352	154

LED Lampadine LED G4 2W 3000 K include. Cod. 222257

0,700 Kg  
0,0211 m<sup>3</sup>  
G4 max 1 x 2W

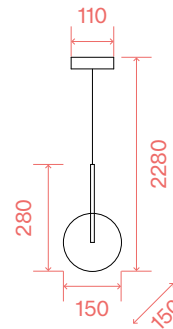

(CONSIGLIATA)

LUMEN	CCT	CODICE	€
200 lm	3000 K	222257	4

FINITURA	CODICE	€
Cromo	306537	132
Ottone	277370	132
Fumé sfum.	326351	132
Ambra sfum.	345345	132

LED Lampadine LED G4 2W 3000 K include. Cod. 222257

0,640 Kg  
0,0170 m<sup>3</sup>  
G4 max 1 x 2W

# EQUINOXE

DA PARETE

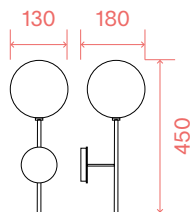

0,990 Kg  
0,0243 m<sup>3</sup>  
G4 max 1 x 2W

(CONSIGLIATA)

LUMEN	CCT	CODICE	€
200 lm	3000 K	222257	4

FINITURA	CODICE	€
Cromo	200132	145
Ottone	200149	145
Fumé sfum.	345338	145
Ambra sfum.	345321	145

Lampadine LED G4 2W 3000 K incluse. Cod. 222257

DA TERRA



IP20



FOTO p. 248

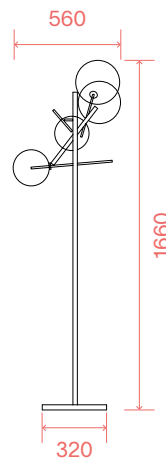

6,500 Kg  
0,0882 m<sup>3</sup>  
G4 max 4 x 2W

(CONSIGLIATA)

LUMEN	CCT	CODICE	€
200 lm	3000 K	222257	4

FINITURA	CODICE	€
Cromo	290959	550
Ottone	290966	550
Fumé sfum.	348292	550
Ambra sfum.	348285	550

Lampadine LED G4 2W 3000 K incluse. Cod. 222257



# ESSENCE

SOSPENSIONE

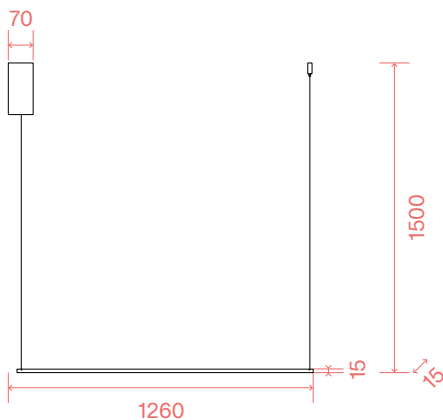

0,900 Kg  
0,0165 m<sup>3</sup>  
LED 19W  
2500/2750 lm

FINITURA	CCT	CODICE	€
Bianco	3000 K	285085	275
Nero	2700 K	341033	275
Nero	3000 K	285092	275
Nero	4000 K	341040	275

Sorgente luminosa LED 2700/3000/4000 K, 30.000 h di durata.

# ESSENCE

DA PARETE / SOFFITTO  IP20  FOTO p. 168

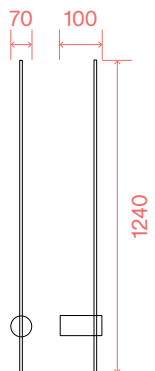

FINITURA	CCT	CODICE	€
Bianco	3000 K	265575	240
Nero	2700 K	341019	240
Nero	3000 K	285108	240
Nero	4000 K	341026	240

 Sorgente luminosa LED  
2700/3000/4000 K, 30.000 h  
di durata.

1,040 Kg  
0,0163 m<sup>3</sup>  
LED 19W  
2500/2700 lm

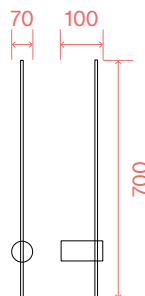

FINITURA	CCT	CODICE	€
Bianco	3000 K	285115	182
Nero	2700 K	340999	182
Nero	3000 K	265643	182
Nero	4000 K	341002	182

 Sorgente luminosa LED  
2700/3000/4000 K, 30.000 h  
di durata.

0,800 Kg  
0,0205 m<sup>3</sup>  
LED 12W  
1550/1700 lm

# FILO

SOSPENSIONE  IP20  FOTO p. 20

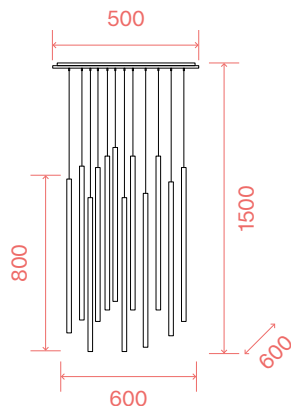

FINITURA	CCT	CODICE	€
Bianco	2700 K	341088	450
Bianco	3000 K	263441	450
Nero	2700 K	341095	450
Nero	3000 K	263434	450
Ottone	2700 K	341101	450
Ottone	3000 K	263663	450

 Sorgente luminosa LED  
2700/3000 K, 20.000 h di  
durata.

8,600 Kg  
0,0635 m<sup>3</sup>  
LED 19W  
1550/1650 lm

# FILO

SOSPENSIONE



IP20



IP20

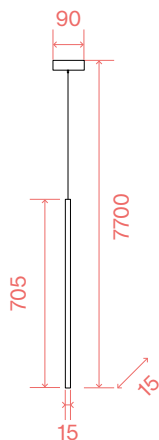

FINITURA	CODICE	€
Bianco	300818	110
Nero	300801	110
Ottone	300825	110

Sorgente luminosa LED  
3000 K, 20.000 h di durata.



0,830 Kg  
0,0105 m<sup>3</sup>  
LED 3,5W / 220 lm

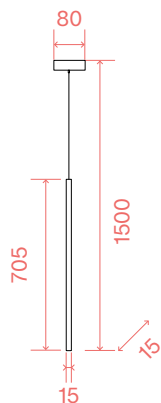

FINITURA	CCT	CODICE	€
Bianco	2700 K	341057	75
Bianco	3000 K	263687	75
Nero	2700 K	341064	75
Nero	3000 K	263670	75
Ottone	2700 K	341071	75
Ottone	3000 K	263700	75

Sorgente luminosa LED  
2700/3000 K, 20.000 h di durata.

0,530 Kg  
0,0142 m<sup>3</sup>  
LED 3,5W / 220 lm

DA PARETE / SOFFITTO



IP20

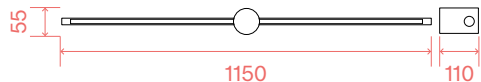

FINITURA	CODICE	€
Bianco	327778	220
Nero	310152	220
Ottone	327785	220

Sorgente luminosa LED  
3000 K, 20.000 h di durata.

0,610 Kg  
0,0138 m<sup>3</sup>  
LED 16W / 1950 lm

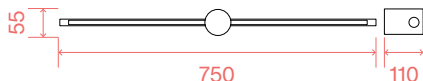

FINITURA	CODICE	€
Bianco	310138	190
Nero	310145	190
Ottone	327792	190

Sorgente luminosa LED  
3000 K, 20.000 h di durata.

0,500 Kg  
0,0093 m<sup>3</sup>  
LED 13W / 1400 lm

# FILO

DA TERRA



IP20



FOTO p. 254

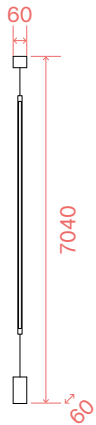

FINITURA	CCT	CODICE	€
Bianco	2700 K	341118	250
Bianco	3000 K	301051	250
Nero	2700 K	341125	250
Nero	3000 K	301068	250
Ottone	2700 K	341132	250
Ottone	3000 K	301075	250

 Sorgente luminosa LED  
2700/3000 K, 20.000 h di  
durata.



1,200 Kg  
0,0124 m<sup>3</sup>  
LED 14W  
1800/1850 lm

DA TAVOLO



IP20

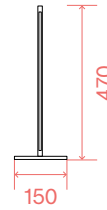

FINITURA	CODICE	€
Bianco	310107	150
Nero	310114	150
Ottone	310121	150

 Sorgente luminosa LED  
3000 K, 20.000 h di durata.



0,500 Kg  
0,0093 m<sup>3</sup>  
LED 10W / 1100 lm

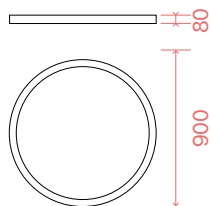

13,000 Kg  
0,1441 m<sup>3</sup>

#### KIT PENDANT (OPTIONAL)

Bianco  
cod. 254289, € 50  
Nero  
cod. 307244, € 50

#### LED SMD SAMSUNG, DRIVER TRIDONIC ON/OFF (INCLUSO)

POTENZA	ANGOLO	LUMEN	CCT	FINITURA	CODICE	€
68 W	87°	7350 lm	2700 K	Bianco	341200	1180
68 W	87°	7350 lm	2700 K	Nero	341217	1180
68 W	87°	9000 lm	3000 K	Bianco	270326	1180
68 W	87°	9000 lm	3000 K	Nero	306629	1180
68 W	87°	9550 lm	4000 K	Bianco	270241	1180
68 W	87°	9550 lm	4000 K	Nero	306636	1180

#### DIMMABLE DRIVER (NON INCLUSO/OPTIONAL)

	POTENZA	OUTPUT	MISURE	CODICE	€
1-10V	68 W	1400 mA	130 x 25 x 75 mm	270357	125
DALI / Push	100 W	1400 mA	140 x 30 x 100 mm	270388	180

#### UPLIGHT (NON INCLUSO/OPTIONAL)

POTENZA	ANGOLO	LUMEN	CCT	CODICE	€
25 W	120°	3500 lm	3000 K	271002	225
25 W	120°	3650 lm	4000 K	270715	225

#### LED SMD SAMSUNG, DRIVER TRIDONIC ON/OFF (INCLUSO)

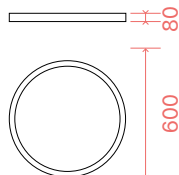

7,200 Kg  
0,0694 m<sup>3</sup>

#### KIT PENDANT (OPTIONAL)

Bianco  
cod. 254289, € 50  
Nero  
cod. 307244, € 50

#### DIMMABLE DRIVER (NON INCLUSO/OPTIONAL)

	POTENZA	OUTPUT	MISURE	CODICE	€
1-10V	60 W	1400 mA	124 x 23 x 82 mm	270340	112
DALI / Push	60 W	1400 mA	125 x 28 x 85 mm	270371	135

#### UPLIGHT (NON INCLUSO/OPTIONAL)

POTENZA	ANGOLO	LUMEN	CCT	CODICE	€
17,5 W	120°	2500 lm	3000 K	270401	150
17,5 W	120°	2650 lm	4000 K	270265	150



# FLY

DA PARETE / SOFFITTO  IP40 MacAdam: SDCM 3 UGR: <19 CRI >90 DURATA LED: 50.000 h

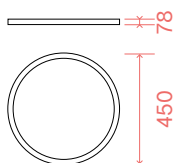

3,800 Kg  
0,0251 m<sup>3</sup>

## KIT PENDANT (OPTIONAL)

Bianco  
cod. 254289, € 50  
Nero  
cod. 307244, € 50

## LED SMD SAMSUNG, DRIVER TRIDONIC ON/OFF (INCLUSO)

POTENZA	ANGOLO	LUMEN	CCT	FINITURA	CODICE	€
26 W	87°	3000 lm	2700 K	Bianco	341163	420
26 W	87°	3000 lm	2700 K	Nero	341170	420
26 W	87°	3900 lm	3000 K	Bianco	254272	420
26 W	87°	3900 lm	3000 K	Nero	306599	420
26 W	87°	4300 lm	4000 K	Bianco	270296	420
26 W	87°	4300 lm	4000 K	Nero	306605	420

## DIMMABLE DRIVER (NON INCLUSO/OPTIONAL)

	POTENZA	OUTPUT	MISURE	CODICE	€
1-10V / Push	32 W	700 mA	94 x 21 x 67 mm	270586	75
DALI / Push	38 W	700 mA	94 x 21 x 67 mm	270593	95

## UPLIGHT (NON INCLUSO/OPTIONAL)

POTENZA	ANGOLO	LUMEN	CCT	CODICE	€
11 W	120°	1350 lm	3000 K	270258	85
11 W	120°	1700 lm	4000 K	270395	85

## LED SMD SAMSUNG, DRIVER TRIDONIC ON/OFF (INCLUSO)

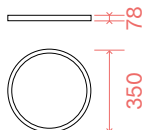

3,000 Kg  
0,0160 m<sup>3</sup>

## KIT PENDANT (OPTIONAL)

Bianco  
cod. 254289, € 50  
Nero  
cod. 307244, € 50

POTENZA	ANGOLO	LUMEN	CCT	FINITURA	CODICE	€
18 W	87°	2150 lm	2700 K	Bianco	341149	315
18 W	87°	2150 lm	2700 K	Nero	341156	315
18 W	87°	2800 lm	3000 K	Bianco	270272	315
18 W	87°	2800 lm	3000 K	Nero	306575	315
18 W	87°	3000 lm	4000 K	Bianco	270289	315
18 W	87°	3000 lm	4000 K	Nero	306582	315

## DIMMABLE DRIVER (NON INCLUSO/OPTIONAL)

	POTENZA	OUTPUT	MISURE	CODICE	€
1-10V / Push	20 W	500 mA	108 x 22 x 52 mm	270333	65
DALI	20 W	500 mA	108 x 22 x 52 mm	270364	85

## UPLIGHT (NON INCLUSO/OPTIONAL)

POTENZA	ANGOLO	LUMEN	CCT	CODICE	€
11 W	120°	1000 lm	3000 K	270258	85
11 W	120°	1300 lm	4000 K	270395	85

# FLY SLIM

DA PARETE / SOFFITTO  IP40 MacAdam: SDCM 3 UGR: <19 CRI >90 DURATA LED: 50.000 h

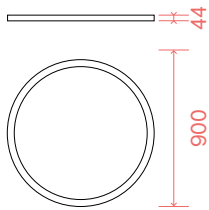

13,000 Kg  
0,1448 m<sup>3</sup>

KIT PENDANT  
(OPTIONAL)  
Bianco  
cod. 254289, € 50

## LED SMD SAMSUNG, DRIVER TRIDONIC ON/OFF (INCLUSO)

POTENZA	ANGOLO	LUMEN	CCT	FINITURA	CODICE	€
68 W	87°	7350 lm	2700 K	Bianco	341255	1125
68 W	87°	9000 lm	3000 K	Bianco	306681	1125
68 W	87°	9550 lm	4000 K	Bianco	306698	1125

## DIMMABLE DRIVER (NON INCLUSO/OPTIONAL)

	POTENZA	OUTPUT	MISURE	CODICE	€
1-10V	68 W	1400 mA	130 x 25 x 75 mm	270357	125
DALI / Push	100 W	1400 mA	140 x 30 x 100 mm	270388	180

## UPLIGHT (NON INCLUSO/OPTIONAL)

POTENZA	ANGOLO	LUMEN	CCT	CODICE	€
25 W	120°	3500 lm	3000 K	271002	225
25 W	120°	3650 lm	4000 K	270715	225

## LED SMD SAMSUNG, DRIVER TRIDONIC ON/OFF (INCLUSO)

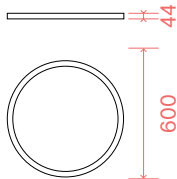

6,150 Kg  
0,0694 m<sup>3</sup>

KIT PENDANT  
(OPTIONAL)  
Bianco  
cod. 254289, € 50

POTENZA	ANGOLO	LUMEN	CCT	FINITURA	CODICE	€
53 W	87°	5600 lm	2700 K	Bianco	341248	575
53 W	87°	7200 lm	3000 K	Bianco	292250	575
53 W	87°	7700 lm	4000 K	Bianco	306674	575

## DIMMABLE DRIVER (NON INCLUSO/OPTIONAL)

	POTENZA	OUTPUT	MISURE	CODICE	€
1-10V	60 W	1400 mA	124 x 23 x 82 mm	270340	112
DALI / Push	60 W	1400 mA	125 x 28 x 85 mm	270371	135

## UPLIGHT (NON INCLUSO/OPTIONAL)

POTENZA	ANGOLO	LUMEN	CCT	CODICE	€
17,5 W	120°	2500 lm	3000 K	270401	150
17,5 W	120°	2650 lm	4000 K	270265	150

# FLY SLIM

DA PARETE / SOFFITTO  IP40 MacAdam: SDCM 3 UGR: <19 CRI >90 DURATA LED: 50.000 h

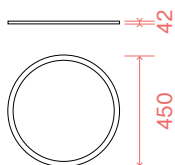

3,750 Kg  
0,0170 m<sup>3</sup>

KIT PENDANT  
(OPTIONAL)  
Bianco  
cod. 254289, € 50

## LED SMD SAMSUNG, DRIVER TRIDONIC ON/OFF (INCLUSO)

POTENZA	ANGOLO	LUMEN	CCT	FINITURA	CODICE	€
26 W	87°	3000 lm	2700 K	Bianco	341231	390
26 W	87°	3900 lm	3000 K	Bianco	292236	390
26 W	87°	4300 lm	4000 K	Bianco	306667	390

## DIMMABLE DRIVER (NON INCLUSO/OPTIONAL)

	POTENZA	OUTPUT	MISURE	CODICE	€
1-10V / Push	32 W	700 mA	94 x 21 x 67 mm	270586	75
DALI / Push	38 W	700 mA	94 x 21 x 67 mm	270593	95

## UPLIGHT (NON INCLUSO/OPTIONAL)

POTENZA	ANGOLO	LUMEN	CCT	CODICE	€
11 W	120°	1350 lm	3000 K	270258	85
11 W	120°	1700 lm	4000 K	270395	85

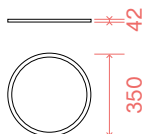

2,700 Kg  
0,0105 m<sup>3</sup>

KIT PENDANT  
(OPTIONAL)  
Bianco  
cod. 254289, € 50

## LED SMD SAMSUNG, DRIVER TRIDONIC ON/OFF (INCLUSO)

POTENZA	ANGOLO	LUMEN	CCT	FINITURA	CODICE	€
18 W	87°	2150 lm	2700 K	Bianco	341224	295
18 W	87°	2800 lm	3000 K	Bianco	306643	295
18 W	87°	3000 lm	4000 K	Bianco	306650	295

## DIMMABLE DRIVER (NON INCLUSO/OPTIONAL)

	POTENZA	OUTPUT	MISURE	CODICE	€
1-10V / Push	20 W	500 mA	108 x 22 x 52 mm	270333	65
DALI	20 W	500 mA	108 x 22 x 52 mm	270364	85

## UPLIGHT (NON INCLUSO/OPTIONAL)

POTENZA	ANGOLO	LUMEN	CCT	CODICE	€
11 W	120°	1000 lm	3000 K	270258	85
11 W	120°	1300 lm	4000 K	270395	85

# FOCUS

DA PARETE



IP20



FOTO p. 174

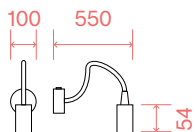

FINITURA	CODICE	€
Bianco	097183	65
Cromo	097206	65
Nero	097190	65

0,400 Kg  
0,0025 m<sup>3</sup>  
LED 4W / 310 lm



Sorgente luminosa LED  
3000 K, 30.000 h di durata.

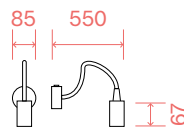

FINITURA	CODICE	€
Bianco	203171	70
Cromo	203188	70
Nero	203195	70

0,410 Kg  
0,0020 m<sup>3</sup>  
LED 3,5W / 280 lm



Sorgente luminosa LED  
3000 K, 20.000 h di durata.



# FRAME

SOSPENSIONE



IP20



FOTO p. 24

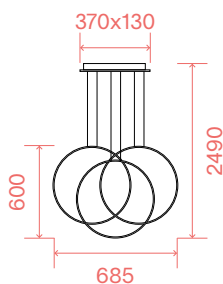

FINITURA	CODICE	€
Bianco	269351	400
Nero	269337	400



Sorgente luminosa LED  
3000 K, 30.000 h di durata.

3,500 Kg  
0,1050 m<sup>3</sup>  
LED 82W / 6850 lm

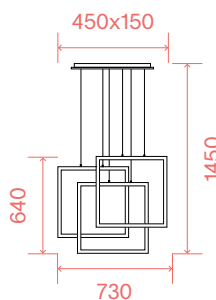

FINITURA	CODICE	€
Bianco	253596	580
Nero	269375	580



Sorgente luminosa LED  
3000 K, 30.000 h di durata.

4,270 Kg  
0,0689 m<sup>3</sup>  
LED 80W / 8550 lm

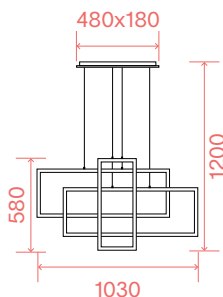

FINITURA	CODICE	€
Bianco	253589	600
Nero	269382	600



Sorgente luminosa LED  
3000 K, 30.000 h di durata.

4,300 Kg  
0,2100 m<sup>3</sup>  
LED 93W / 1005 lm

# FRAME

DA PARETE / SOFFITTO  IP20  FOTO p. 130

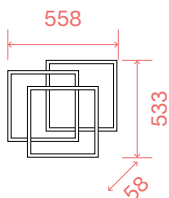

1,430 Kg  
0,0530 m<sup>3</sup>  
LED 33W  
3800/4200 lm

FINITURA	CCT	CODICE	€
Bianco	2700 K	341316	320
Bianco	3000 K	230702	320
Nero	3000 K	270678	320

 Sorgente luminosa LED  
2700/3000 K, 30.000 h di  
durata.

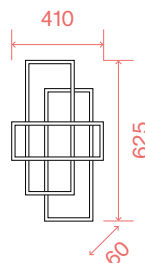

1,260 Kg  
0,0241 m<sup>3</sup>  
LED 33W  
3400/3850 lm

FINITURA	CCT	CODICE	€
Bianco	2700 K	341323	290
Bianco	3000 K	230726	290
Nero	3000 K	270661	290

 Sorgente luminosa LED  
2700/3000 K, 30.000 h di  
durata.

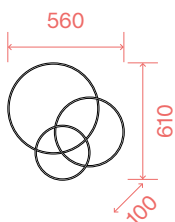

1,600 Kg  
0,0458 m<sup>3</sup>  
LED 41W  
4550/5000 lm

FINITURA	CCT	CODICE	€
Bianco	2700 K	341309	320
Bianco	3000 K	255019	320
Nero	3000 K	269825	320

 Sorgente luminosa LED  
2700/3000 K, 30.000 h di  
durata.

## DA TERRA

 IP20

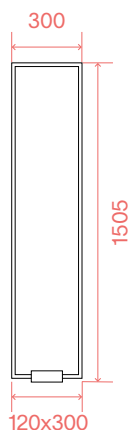

10,300 Kg  
0,0525 m<sup>3</sup>  
LED 30W / 3100 lm

FINITURA	CODICE	€
Bianco	299624	450
Nero	299617	450

 Sorgente luminosa LED  
3000 K, 30.000 h di durata.



# FUTURA

DA TAVOLO

IP20  FOTO p. 200

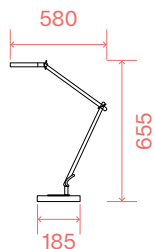

1,830 Kg  
0,0069 m<sup>3</sup>  
LED 12,5W / 1050 lm

FINITURA	CODICE	€
Bianco	272078	150
Alluminio	204895	150
Nero	204888	150

 Sorgente luminosa LED  
4000 K, 25.000 h di durata.



DA TERRA

IP20 

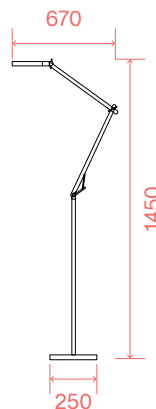

4,440 Kg  
0,0095 m<sup>3</sup>  
LED 12,5W / 1050 lm

FINITURA	CODICE	€
Bianco	272085	215
Alluminio	204956	215
Nero	204949	215

 Sorgente luminosa LED  
4000 K, 25.000 h di durata.



# GEMINI

SOSPENSIONE

IP20  FOTO p. 32

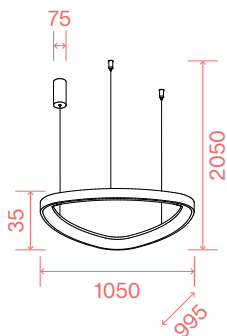

4,000 Kg  
0,1145 m<sup>3</sup>  
LED 78W  
8500/8700 lm

ON-OFF

FINITURA	CCT	CODICE	€
Bianco	2700 K	341613	650
Bianco	3000 K	303895	650
Nero	2700 K	341620	650
Nero	3000 K	307695	650
Ottone	2700 K	341637	650
Ottone	3000 K	307701	650

 Sorgente luminosa LED  
2700/3000 K, 50.000 h di  
durata.

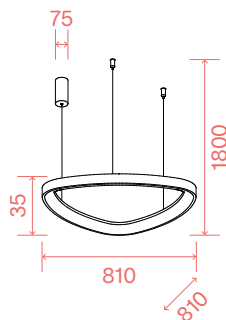

2,300 Kg  
0,0703 m<sup>3</sup>  
LED 55/56W  
6200/6300 lm

ON-OFF

FINITURA	CCT	CODICE	€
Bianco	2700 K	341583	430
Bianco	3000 K	247274	430
Nero	2700 K	341590	430
Nero	3000 K	247281	430
Ottone	2700 K	341606	430
Ottone	3000 K	269849	430

DALI/PUSH

FINITURA	CODICE	€
Bianco	304748	525
Nero	304724	525
Ottone	304731	525

 Sorgente luminosa LED  
2700/3000 K, 50.000 h di  
durata.

# GEMINI

SOSPENSIONE



IP20



FOTO p. 32

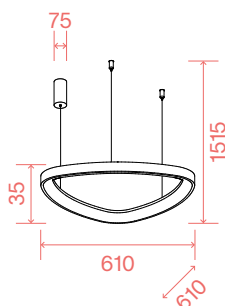

ON-OFF

FINITURA	CCT	CODICE	€
Bianco	2700 K	341552	330
Bianco	3000 K	247250	330
Nero	2700 K	341569	330
Nero	3000 K	247267	330
Ottone	2700 K	341576	330
Ottone	3000 K	269832	330

1,710 Kg  
0,0462 m<sup>3</sup>  
LED 47W  
4950/5100 lm

DALI/PUSH

FINITURA	CODICE	€
Bianco	304717	425
Nero	304694	425
Ottone	304700	425



Sorgente luminosa LED  
2700/3000 K, 50.000 h di  
durata.

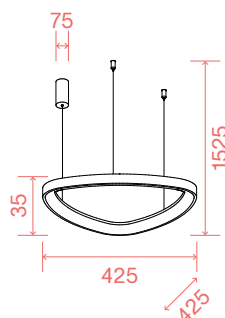

ON-OFF

FINITURA	CCT	CODICE	€
Bianco	2700 K	341521	240
Bianco	3000 K	247229	240
Nero	2700 K	341538	240
Nero	3000 K	247236	240
Ottone	2700 K	341545	240
Ottone	3000 K	247243	240

1,450 Kg  
0,0201 m<sup>3</sup>  
LED 36W  
4000/4150 lm



Sorgente luminosa LED  
2700/3000 K, 50.000 h di  
durata.

DA PARETE / SOFFITTO



IP20

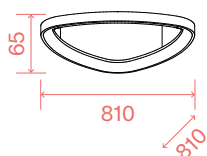

ON-OFF

FINITURA	CCT	CODICE	€
Bianco	2700 K	341491	390
Bianco	3000 K	328072	390
Nero	2700 K	341507	390
Nero	3000 K	328089	390
Ottone	2700 K	341514	390
Ottone	3000 K	328096	390

4,800 Kg  
0,0919 m<sup>3</sup>  
LED 42W  
4150/4450 lm

DALI/PUSH

FINITURA	CODICE	€
Bianco	328973	480
Nero	328980	480
Ottone	329260	480



Sorgente luminosa LED  
2700/3000 K, 50.000 h di  
durata.

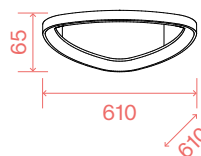

ON-OFF

FINITURA	CODICE	€	
Bianco	2700 K	341460	300
Bianco	3000 K	328041	300
Nero	2700 K	341477	300
Nero	3000 K	328058	300
Ottone	2700 K	341484	300
Ottone	3000 K	328065	300

3,200 Kg  
0,0507 m<sup>3</sup>  
LED 30W  
3300/3600 lm

LED 28W  
3100 lm

DALI/PUSH

FINITURA	CODICE	€
Bianco	328942	380
Nero	328959	380
Ottone	328966	380



Sorgente luminosa LED  
2700/3000 K, 50.000 h di  
durata.

# GEMINI

DA PARETE / SOFFITTO  IP20

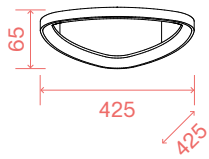

1,900 Kg  
0,0271 m<sup>3</sup>  
LED 24W  
2300/2900 lm

ON-OFF

FINITURA	CCT	CODICE	€
Bianco	2700 K	341439	220
Bianco	3000 K	328010	220
Nero	2700 K	341446	220
Nero	3000 K	328027	220
Ottone	2700 K	341453	220
Ottone	3000 K	328034	220

 Sorgente luminosa LED  
2700/3000 K, 50.000 h di  
durata.

# LOOK

SOSPENSIONE  IP20  FOTO p. 38

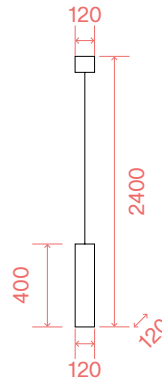

2,950 Kg  
0,0092 m<sup>3</sup>  
GU10 max 1 x 50W

(CONSIGLIATA)

LUMEN	CCT	CODICE	€
750 lm	3000 K	189031	15

FINITURA	CODICE	€
Nero	158723	140

 Lampadine LED GU10 10W  
3000 K include. Cod. 189031

# LOOK

SOSPENSIONE  IP20  FOTO p. 38

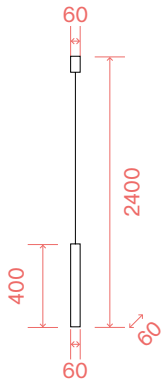

0,990 Kg  
0,0029 m<sup>3</sup>  
GU10 max 1 x 28W

(CONSIGLIATA)

LUMEN	CCT	CODICE	€
540 lm	3000 K	123943	3,50

FINITURA	CODICE	€
Bianco	104935	60
Cromo	104942	80
Nero	104928	60
Trasparente	194806	80
Argento	141800	80
Oro	141817	80
Ottone	259239	60
Brunito	141794	80
Rame	141855	80
Coffee	170589	80

 Lampadine LED GU10 7W  
3000 K include. Cod. 123943

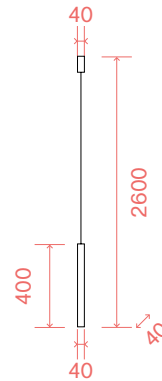

0,650 Kg  
0,0019 m<sup>3</sup>  
GU10 max 1 x 28W

(CONSIGLIATA)

LUMEN	CCT	CODICE	€
340 lm	3000 K	339771	3

FINITURA	CODICE	€
Bianco	346854	65
Cromo	346861	65
Nero	343310	65

 Lampadine LED GU10 4W  
3000 K include. Cod. 339771



# LOOK

## DA SOFFITTO

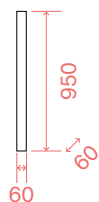

3,070 Kg  
0,0053 m<sup>3</sup>  
GU10 max 1 x 28W

(CONSIGLIATA)

LUMEN	CCT	CODICE	€
540 lm	3000 K	123943	3,50
FINITURA		CODICE	€
Bianco		259260	86
Nero		259277	86

Lampadine LED GU10 7W  
3000 K include. Cod. 123943

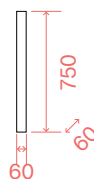

1,380 Kg  
0,0043 m<sup>3</sup>  
GU10 max 1 x 28W

(CONSIGLIATA)

LUMEN	CCT	CODICE	€
540 lm	3000 K	123943	3,50
FINITURA		CODICE	€
Bianco		233352	60
Nero		233321	60

Lampadine LED GU10 7W  
3000 K include. Cod. 123943

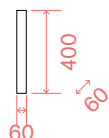

0,740 Kg  
0,0025 m<sup>3</sup>  
GU10 max 1 x 28W

(CONSIGLIATA)

LUMEN	CCT	CODICE	€
540 lm	3000 K	123943	3,50
FINITURA		CODICE	€
Bianco		233215	42
Nero		233192	42

Lampadine LED GU10 7W  
3000 K include. Cod. 123943

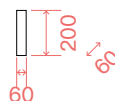

0,400 Kg  
0,0013 m<sup>3</sup>  
GU10 max 1 x 28W

(CONSIGLIATA)

LUMEN	CCT	CODICE	€
540 lm	3000 K	123943	3,50
FINITURA		CODICE	€
Bianco		233079	32
Nero		285214	32
Ottone		233062	32

Lampadine LED GU10 7W  
3000 K include. Cod. 123943

## DA PARETE

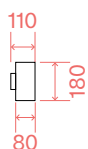

0,500 Kg  
0,0028 m<sup>3</sup>  
GU10 max 2 x 28W

(CONSIGLIATA)

LUMEN	CCT	CODICE	€
540 lm	3000 K	123943	3,50
FINITURA		CODICE	€
Bianco		096018	80
Cromo		094182	80
Nero		095998	80
Rame		164847	80
Brunito		164823	80

Lampadine LED GU10 7W  
3000 K include. Cod. 123943

## DA TERRA

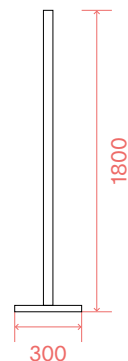

5,080 Kg  
0,0809 m<sup>3</sup>  
LED 24W / 2750 lm

FINITURA	CODICE	€
Bianco	304922	250
Nero	304915	250

Sorgente luminosa LED  
3000 K, 30.000 h di durata.



# LOOK

PER BINARI

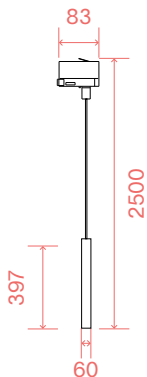

(CONSIGLIATA)

LUMEN	CCT	CODICE	€
540 lm	3000 K	123943	3,50

FINITURA	CODICE	€
Bianco	231662	80
Nero	231631	80

Lampadine LED GU10 7W  
3000 K incluse. Cod. 123943

LINK SINGLE CONNECTION

NECESSARIO	DRIVER
NO	On/Off

FINITURA	CODICE	€
Bianco	170145	23
Nero	170152	23

0,930 Kg  
0,0037 m<sup>3</sup>  
GU10 max 1 x 28W

# MAPA

SOSPENSIONE



IP20 FOTO p. 46



IP20

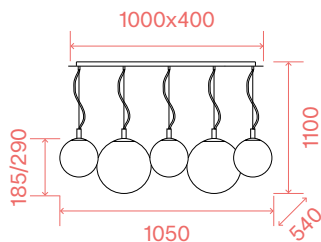

(CONSIGLIATA)

LUMEN	CCT	CODICE	€
910 lm	3000 K	119571	3,50

FINITURA	CODICE	€
Bianco	043562	530

8,700 Kg  
0,2470 m<sup>3</sup>  
E27 max 5 x 42W

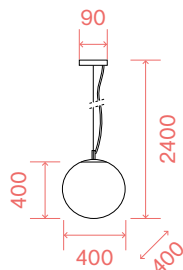

(CONSIGLIATA)

LUMEN	CCT	CODICE	€
910 lm	3000 K	119571	3,50

FINITURA	CODICE	€
Bianco	032139	155

3,620 Kg  
0,1215 m<sup>3</sup>  
E27 max 1 x 42W

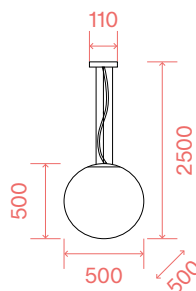

(CONSIGLIATA)

LUMEN	CCT	CODICE	€
910 lm	3000 K	119571	3,50

FINITURA	CODICE	€
Bianco	032122	315

5,390 Kg  
0,2254 m<sup>3</sup>  
E27 max 1 x 42W

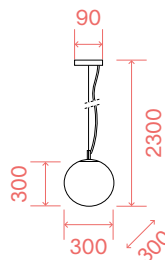

(CONSIGLIATA)

LUMEN	CCT	CODICE	€
910 lm	3000 K	119571	3,50

FINITURA	CODICE	€
Bianco	009087	90

1,920 Kg  
0,0630 m<sup>3</sup>  
E27 max 1 x 42W

# MAPA

## SOSPENSIONE

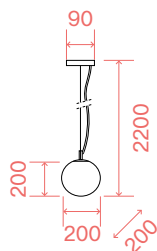

(CONSIGLIATA)

LUMEN	CCT	CODICE	€
910 lm	3000 K	119571	3,50

FINITURA	CODICE	€
Bianco	009148	70

1,130 Kg  
0,0272 m<sup>3</sup>  
E27 max 1 x 42W

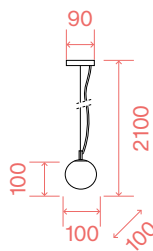

(CONSIGLIATA)

LUMEN	CCT	CODICE	€
510 lm	3000 K	305486	6

FINITURA	CODICE	€
Bianco	310800	50

0,041 Kg  
0,0027 m<sup>3</sup>  
G9 max 1 x 4W

Lampadine LED G9 3W 3000 K  
Cod. 209043

## DA PARETE/SOFFITTO

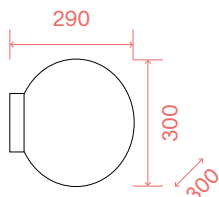

(CONSIGLIATA)

LUMEN	CCT	CODICE	€
430 lm	3000 K	101279	2

FINITURA	CODICE	€
Bianco	059822	88

1,660 Kg  
0,0647 m<sup>3</sup>  
E27 max 1 x 42W

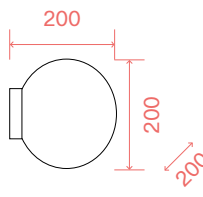

(CONSIGLIATA)

LUMEN	CCT	CODICE	€
430 lm	3000 K	101279	2

FINITURA	CODICE	€
Bianco	059815	50

0,900 Kg  
0,0259 m<sup>3</sup>  
E27 max 1 x 42W

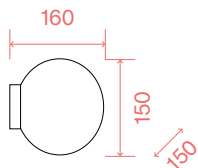

(CONSIGLIATA)

LUMEN	CCT	CODICE	€
510 lm	3000 K	305486	6

FINITURA	CODICE	€
Bianco	059808	44

0,380 Kg  
0,0115 m<sup>3</sup>  
G9 max 1 x 15W

Lampadine LED G9 3W 3000 K  
Cod. 209043

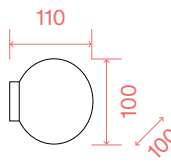

(CONSIGLIATA)

LUMEN	CCT	CODICE	€
510 lm	3000 K	305486	6

FINITURA	CODICE	€
Bianco	310787	35

0,230 Kg  
0,0025 m<sup>3</sup>  
G9 max 1 x 4W

Lampadine LED G9 3W 3000 K  
Cod. 209043

# MAPA

DA SOFFITTO

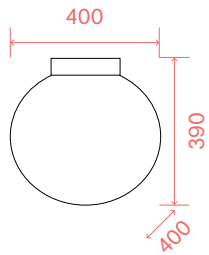

(CONSIGLIATA)

LUMEN	CCT	CODICE	€
910 lm	3000 K	119571	3,50

FINITURA	CODICE	€
Bianco	059839	188

2,590 Kg  
0,1290 m<sup>3</sup>  
E27 max 1 x 42W

DA TAVOLO

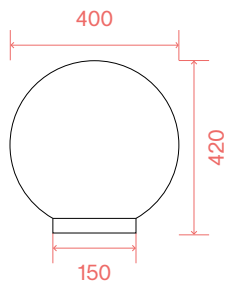

(CONSIGLIATA)

LUMEN	CCT	CODICE	€
910 lm	3000 K	119571	3,50

FINITURA	CODICE	€
Bianco	000206	165



3,520 Kg  
0,1354 m<sup>3</sup>  
E27 max 1 x 42W

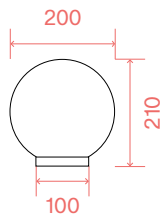

(CONSIGLIATA)

LUMEN	CCT	CODICE	€
910 lm	3000 K	119571	3,50

FINITURA	CODICE	€
Bianco	009155	50



1,050 Kg  
0,0214 m<sup>3</sup>  
E27 max 1 x 42W

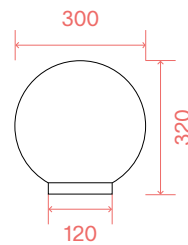

(CONSIGLIATA)

LUMEN	CCT	CODICE	€
910 lm	3000 K	119571	3,50

FINITURA	CODICE	€
Bianco	009131	85



1,880 Kg  
0,0515 m<sup>3</sup>  
E27 max 1 x 42W

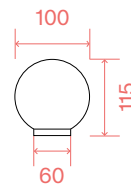

(CONSIGLIATA)

LUMEN	CCT	CODICE	€
510 lm	3000 K	305486	6

FINITURA	CODICE	€
Bianco	310817	45



0,280 Kg  
0,0026 m<sup>3</sup>  
G9 max 1 x 4W

Lampadine LED G9 3W 3000 K  
Cod. 209043



# MINT

SOSPENSIONE



IP20



FOTO p. 52

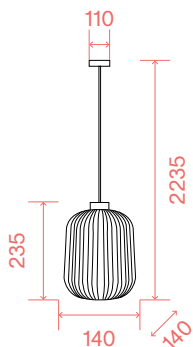

1,350 Kg  
0,0147 m<sup>3</sup>  
E27 max 1 x 60W

(CONSIGLIATA)

LUMEN	CCT	CODICE	€
910 lm	3000 K	119571	3,50

FINITURA	CODICE	€
Fumè	237442	105
Verde	248554	105

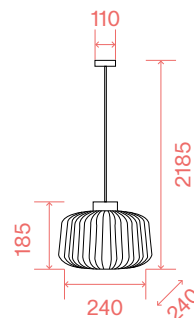

1,560 Kg  
0,0532 m<sup>3</sup>  
E27 max 1 x 60W

(CONSIGLIATA)

LUMEN	CCT	CODICE	€
910 lm	3000 K	119571	3,50

FINITURA	CODICE	€
Fumè	237398	127
Verde	237428	127

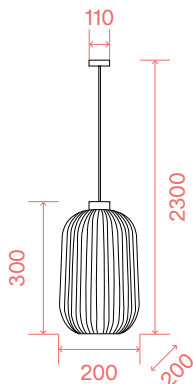

1,80 Kg  
0,0269 m<sup>3</sup>  
E27 max 1 x 60W

(CONSIGLIATA)

LUMEN	CCT	CODICE	€
910 lm	3000 K	119571	3,50

FINITURA	CODICE	€
Fumè	237510	138
Verde	237497	138

# MIX UP

SOSPENSIONE



IP20



FOTO p. 56

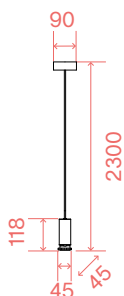

0,460 Kg  
0,0018 m<sup>3</sup>  
E27 max 1 x 60W

(CONSIGLIATA)

LUMEN	CCT	CODICE	€
900 lm	3000 K	123899	3,50

FINITURA	CODICE	€
Bianco	288406	55
Nero	288390	55

DA SOFFITTO



IP20

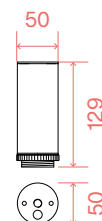

0,270 Kg  
0,0005 m<sup>3</sup>  
E27 max 1 x 60W

(CONSIGLIATA)

LUMEN	CCT	CODICE	€
900 lm	3000 K	123899	3,50

FINITURA	CODICE	€
Bianco	292847	35
Nero	292830	35

# MIX UP

DA TERRA

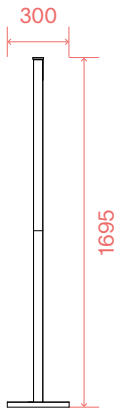

8,500 Kg  
0,0326 m<sup>3</sup>  
E27 max 1 x 42W

(CONSIGLIATA)

LUMEN	CCT	CODICE	€
900 lm	3000 K	123899	3,50

FINITURA	CODICE	€
Bianco	328164	200
Nero	328171	200

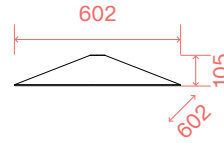

2,000 Kg  
0,0676 m<sup>3</sup>

FINITURA	CODICE	€
Bianco	288437	85
Nero	288420	85

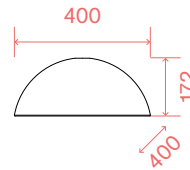

1,100 Kg  
0,0446 m<sup>3</sup>

FINITURA	CODICE	€
Bianco	307404	55
Nero	288475	55

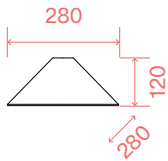

0,500 Kg  
0,0174 m<sup>3</sup>

FINITURA	CODICE	€
Bianco	307428	35
Nero	288451	35

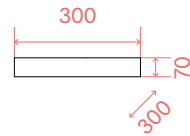

0,800 Kg  
0,0147 m<sup>3</sup>

FINITURA	CODICE	€
Bianco	307411	40
Nero	288444	40

# MOBY

SOSPENSIONE



IP20 [↑ FOTO p. 68](#)

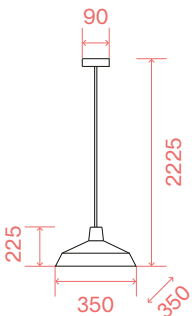

1,200 Kg  
0,0356 m<sup>3</sup>  
E27 max 1 x 42W

(CONSIGLIATA)

LUMEN	CCT	CODICE	€
950 lm	3000 K	101330	4,50

FINITURA	CODICE	€
Bianco	102047	127
Nero	093659	127
Rame	093697	127

# NEMO

SOSPENSIONE



IP20



FOTO p. 74

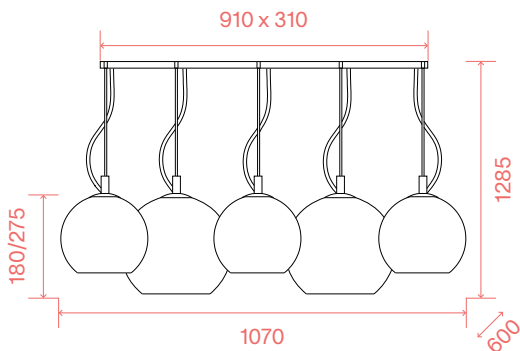

8,700 Kg  
0,2424 m<sup>3</sup>  
E27 max 5 x 42W

(CONSIGLIATA)

LUMEN	CCT	CODICE	€
910 lm	3000 K	119571	3,50

FINITURA	CODICE	€
Cromo Sfum.	138305	520

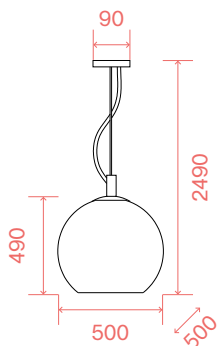

(CONSIGLIATA)

LUMEN	CCT	CODICE	€
1050 lm	3000 K	101347	6

FINITURA	CODICE	€
Fumè	094137	450

4,000 Kg  
0,2220 m<sup>3</sup>  
E27 max 1 x 42W

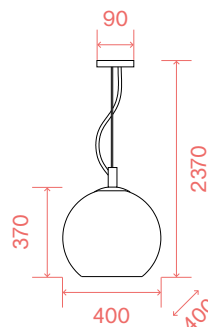

(CONSIGLIATA)

LUMEN	CCT	CODICE	€
1050 lm	3000 K	101347	6

FINITURA	CODICE	€
Trasparente	052816	200
Cromo sfum.	250359	200
Fumè	094229	200
Cromo	250342	200
Rame	111919	200
Ambra	339061	200

2,700 Kg  
0,1227 m<sup>3</sup>  
E27 max 1 x 42W

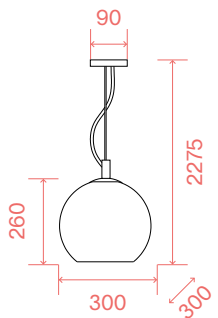

(CONSIGLIATA)

LUMEN	CCT	CODICE	€
1050 lm	3000 K	101323	4,50

FINITURA	CODICE	€
Trasparente	052809	115
Cromo sfum.	149592	115
Fumè	094236	115
Cromo	250335	115
Rame	111902	115
Ambra	339054	115

2,050 Kg  
0,0664 m<sup>3</sup>  
E27 max 1 x 42W

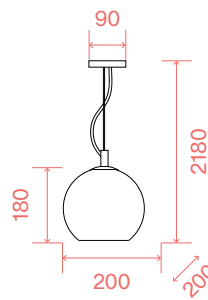

(CONSIGLIATA)

LUMEN	CCT	CODICE	€
1050 lm	3000 K	101323	4,50

FINITURA	CODICE	€
Cromo sfum.	149585	75
Fumè	250311	75
Cromo	250304	75
Rame	250328	75
Ambra	339047	75

1,300 Kg  
0,0241 m<sup>3</sup>  
E27 max 1 x 42W

# NINFEA

DA SOFFITTO

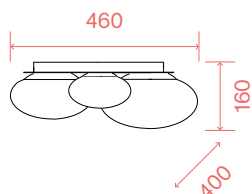

(CONSIGLIATA)

LUMEN	CCT	CODICE	€
910 lm	3000 K	123936	5

FINITURA	CODICE	€
Bianco	306964	275
Ottone	293660	275

Lampadine LED GX53 9W  
3000 K incluse. Cod. 123936

2,550 Kg  
0,0484 m<sup>3</sup>  
GX53 max 3 x 15W

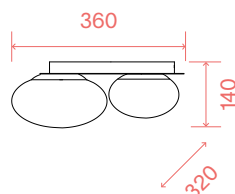

(CONSIGLIATA)

LUMEN	CCT	CODICE	€
910 lm	3000 K	123936	5

FINITURA	CODICE	€
Bianco	306957	195
Ottone	293653	195

Lampadine LED GX53 9W  
3000 K incluse. Cod. 123936

1,700 Kg  
0,0302 m<sup>3</sup>  
GX53 max 2 x 15W

DA PARETE / SOFFITTO



FOTO p. 178

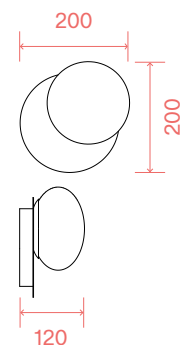

(CONSIGLIATA)

LUMEN	CCT	CODICE	€
910 lm	3000 K	123936	5

FINITURA	CODICE	€
Bianco	306940	105
Ottone	293646	105

Lampadine LED GX53 9W  
3000 K incluse. Cod. 123936

2,550 Kg  
0,0484 m<sup>3</sup>  
GX53 max 1 x 15W

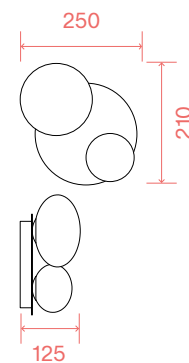

(CONSIGLIATA)

LUMEN	CCT	CODICE	€
510 lm	3000 K	305486	6

FINITURA	CODICE	€
Bianco	327716	132
Ottone	346533	132

Lampadine LED G9 3W 3000 K  
incluse. Cod. 209043

0,800 Kg  
0,0063 m<sup>3</sup>  
G9 max 2 x 4W

DA TAVOLO

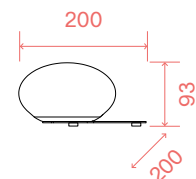

(CONSIGLIATA)

LUMEN	CCT	CODICE	€
910 lm	3000 K	123936	5

FINITURA	CODICE	€
Bianco	318325	99
Ottone	346526	99

Lampadine LED GX53 9W  
3000 K incluse. Cod. 123936

1,100 Kg  
0,0158 m<sup>3</sup>  
GX53 max 1 x 15W





# NITRO ROUND

DA SOFFITTO



IP20



FOTO p. 134



IP20

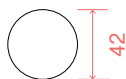
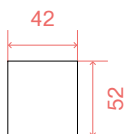

FINITURA	CCT	CODICE	€
Bianco	2700 K	342788	45
Bianco	3000 K	299419	45
Nero	2700 K	342795	45
Nero	3000 K	299402	45



Sorgente luminosa LED  
2700/3000 K, 50.000 h di  
durata.



0,700 Kg  
0,0004 m<sup>3</sup>  
LED 4W  
290/320 lm

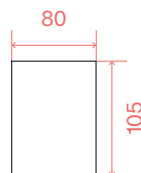

FINITURA	CCT	CODICE	€
Bianco	2700 K	341781	65
Bianco	3000 K	205991	65
Nero	2700 K	341798	65
Nero	3000 K	206004	65



Sorgente luminosa LED  
2700/3000 K, 50.000 h di  
durata.

0,400 Kg  
0,0011 m<sup>3</sup>  
LED 10W  
900/1000 lm



IP20

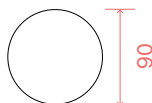
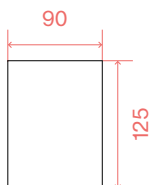

FINITURA	CCT	CODICE	€
Bianco	3000 K	205977	90
Nero	3000 K	205984	90



Sorgente luminosa LED  
2700/3000 K, 50.000 h di  
durata.

0,910 Kg  
0,0030 m<sup>3</sup>  
LED 15W / 1400 lm



IP20

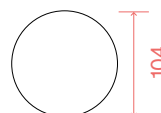
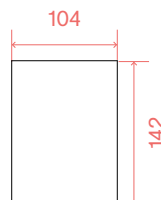

FINITURA	CCT	CODICE	€
Bianco	3000 K	319568	115
Nero	3000 K	322711	115



Sorgente luminosa LED  
2700/3000 K, 50.000 h di  
durata.

0,860 Kg  
0,0018 m<sup>3</sup>  
LED 25W / 2350 lm

# NITRO SQUARE

DA SOFFITTO



IP20

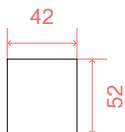

FINITURA	CODICE	€
Bianco	319797	67
Nero	319803	67

Sorgente luminosa LED  
3000 K, 50.000 h di durata.



0,100 Kg  
0,0004 m<sup>3</sup>  
LED 5W  
370/450 lm



IP20

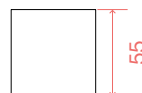
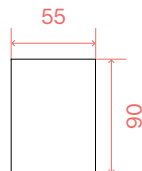

FINITURA	CODICE	€
Bianco	206035	65
Nero	206042	65

Sorgente luminosa LED  
3000 K, 50.000 h di durata.

0,230 Kg  
0,0005 m<sup>3</sup>  
LED 10W / 1000 lm



IP20

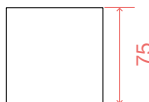
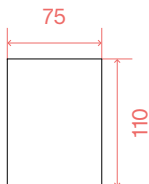

FINITURA	CODICE	€
Bianco	206011	90
Nero	206028	90

Sorgente luminosa LED  
3000 K, 50.000 h di durata.

0,400 Kg  
0,0013 m<sup>3</sup>  
LED 15W / 1400 lm



IP20

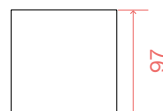
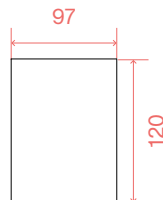

FINITURA	CODICE	€
Bianco	319575	115
Nero	319582	115

Sorgente luminosa LED  
3000 K, 50.000 h di durata.

0,700 Kg  
0,0016 m<sup>3</sup>  
LED 25W / 2350 lm

# ORACLE SLIM

SOSPENSIONE



IP20 DURATA LED: 50.000 h

↑ FOTO p. 80

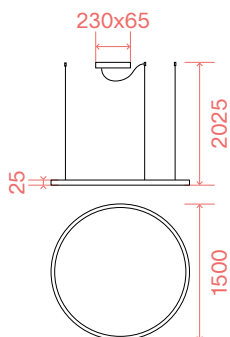

Lunghezza cavo  
2500 mm

## LED SMD (DRIVER INCLUSO)

DIMENSIONI	PESO	VOLUME	POTENZA	DRIVER	LUMEN	CCT	FINITURA	CODICE	€
ø 1500	1,800 Kg	0,3072 m <sup>3</sup>	83 W	On-Off	7850 lm	2700 K	Bianco	342177	490
ø 1500	1,800 Kg	0,3072 m <sup>3</sup>	87 W	On-Off	7850 lm	2700 K	Nero	342160	490
ø 1500	2,480 Kg	0,3072 m <sup>3</sup>	83 W	On-Off	8750 lm	3000 K	Bianco	265957	490
ø 1500	2,480 Kg	0,3072 m <sup>3</sup>	83 W	On-Off	8750 lm	3000 K	Nero	285061	490
ø 1500	2,480 Kg	0,3072 m <sup>3</sup>	83 W	On-Off	9350 lm	4000 K	Bianco	285078	490
ø 1500	2,000 Kg	0,3072 m <sup>3</sup>	83 W	On-Off	9350 lm	4000 K	Nero	304472	490
ø 1500	2,000 Kg	0,3072 m <sup>3</sup>	77 W	DALI/Push	7300 lm	3000 K	Bianco	304465	625
ø 1500	2,000 Kg	0,3072 m <sup>3</sup>	77 W	DALI/Push	7300 lm	3000 K	Nero	304458	625
ø 1500	2,000 Kg	0,3072 m <sup>3</sup>	77 W	DALI/Push	7450 lm	4000 K	Bianco	342191	625
ø 1500	2,000 Kg	0,3072 m <sup>3</sup>	77 W	DALI/Push	7450 lm	4000 K	Nero	342184	625

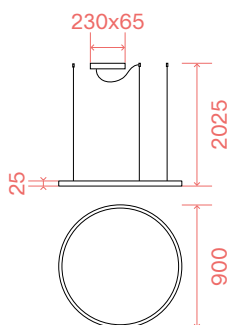

Lunghezza cavo  
2500 mm

## LED SMD (DRIVER INCLUSO)

DIMENSIONI	PESO	VOLUME	POTENZA	DRIVER	LUMEN	CCT	FINITURA	CODICE	€
ø 900	1,720 Kg	0,0839 m <sup>3</sup>	53 W	On-Off	5150 lm	2700 K	Bianco	342115	260
ø 900	1,720 Kg	0,0839 m <sup>3</sup>	53 W	On-Off	5150 lm	2700 K	Nero	342108	260
ø 900	1,800 Kg	0,2212 m <sup>3</sup>	53 W	On-Off	5200 lm	3000 K	Bianco	229478	260
ø 900	1,800 Kg	0,2212 m <sup>3</sup>	53 W	On-Off	5200 lm	3000 K	Nero	229508	260
ø 900	1,800 Kg	0,2212 m <sup>3</sup>	53 W	On-Off	5350 lm	4000 K	Bianco	269870	260
ø 900	1,800 Kg	0,2212 m <sup>3</sup>	53 W	On-Off	5350 lm	4000 K	Nero	304441	260
ø 900	1,500 Kg	0,0857 m <sup>3</sup>	43 W	DALI/Push	4500 lm	3000 K	Bianco	304434	375
ø 900	1,500 Kg	0,0857 m <sup>3</sup>	43 W	DALI/Push	4500 lm	3000 K	Nero	304427	375
ø 900	1,480 Kg	0,0839 m <sup>3</sup>	42 W	DALI/Push	4600 lm	4000 K	Bianco	342139	375
ø 900	1,480 Kg	0,0839 m <sup>3</sup>	42 W	DALI/Push	4600 lm	4000 K	Nero	342122	375

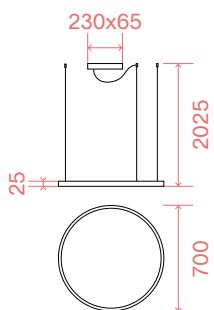

Lunghezza cavo  
2500 mm

## LED SMD (DRIVER INCLUSO)

DIMENSIONI	PESO	VOLUME	POTENZA	DRIVER	LUMEN	CCT	FINITURA	CODICE	€
ø 700	1,260 Kg	0,0534 m <sup>3</sup>	37 W	On-Off	3800 lm	2700 K	Bianco	342054	245
ø 700	1,260 Kg	0,0534 m <sup>3</sup>	37 W	On-Off	3800 lm	2700 K	Nero	342047	245
ø 700	1,660 Kg	0,0809 m <sup>3</sup>	37 W	On-Off	4250 lm	3000 K	Bianco	229485	245
ø 700	1,660 Kg	0,0809 m <sup>3</sup>	37 W	On-Off	4250 lm	3000 K	Nero	229515	245
ø 700	1,660 Kg	0,0809 m <sup>3</sup>	37 W	On-Off	4350 lm	4000 K	Bianco	269863	245
ø 700	1,660 Kg	0,0809 m <sup>3</sup>	37 W	On-Off	4350 lm	4000 K	Nero	304410	245
ø 700	1,200 Kg	0,0534 m <sup>3</sup>	37 W	DALI/Push	4200 lm	3000 K	Bianco	304403	305
ø 700	1,200 Kg	0,0534 m <sup>3</sup>	37 W	DALI/Push	4200 lm	3000 K	Nero	304397	305
ø 700	1,200 Kg	0,0534 m <sup>3</sup>	40 W	DALI/Push	4450 lm	4000 K	Bianco	342078	305
ø 700	1,200 Kg	0,0534 m <sup>3</sup>	40 W	DALI/Push	4450 lm	4000 K	Nero	342061	305

# ORACLE SLIM

SOSPENSIONE



IP20 DURATA LED: 50.000 h

↑ FOTO p. 80

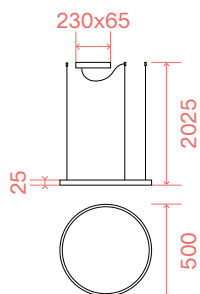

Lunghezza cavo  
2500 mm

## LED SMD (DRIVER INCLUSO)

DIMENSIONI	PESO	VOLUME	POTENZA	DRIVER	LUMEN	CCT	FINITURA	CODICE	€
ø 500	1,200 Kg	0,0272 m <sup>3</sup>	29 W	On-Off	2850 lm	2700 K	Bianco	342016	180
ø 500	1,200 Kg	0,0272 m <sup>3</sup>	29 W	On-Off	2850 lm	2700 K	Nero	342009	180
ø 500	1,400 Kg	0,0376 m <sup>3</sup>	29 W	On-Off	3000 lm	3000 K	Bianco	229461	180
ø 500	1,400 Kg	0,0376 m <sup>3</sup>	29 W	On-Off	3000 lm	3000 K	Nero	229492	180
ø 500	1,400 Kg	0,0376 m <sup>3</sup>	29 W	On-Off	3400 lm	4000 K	Bianco	269856	180
ø 500	1,400 Kg	0,0376 m <sup>3</sup>	29 W	On-Off	3400 lm	4000 K	Nero	304380	180
ø 500	1,100 Kg	0,0272 m <sup>3</sup>	29 W	DALI/Push	2850 lm	3000 K	Bianco	304373	255
ø 500	1,100 Kg	0,0272 m <sup>3</sup>	29 W	DALI/Push	2850 lm	3000 K	Nero	304366	255
ø 500	1,170 Kg	0,0272 m <sup>3</sup>	28 W	DALI/Push	3100 lm	4000 K	Bianco	342030	255
ø 500	1,170 Kg	0,0272 m <sup>3</sup>	28 W	DALI/Push	3100 lm	4000 K	Nero	342023	255

# ORACLE SLIM

SOSPENSIONE



IP20 DURATA LED: 50.000 h

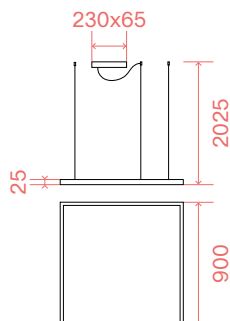

Lunghezza cavo  
2500 mm

## LED SMD (DRIVER ON/OFF INCLUSO)

DIMENSIONI	PESO	VOLUME	POTENZA	DRIVER	LUMEN	CCT	FINITURA	CODICE	€
900 x 900	2,100 Kg	0,1317 m <sup>3</sup>	53 W	On-Off	5200 lm	3000 K	Bianco	259192	260
900 x 900	2,100 Kg	0,1317 m <sup>3</sup>	53 W	On-Off	5200 lm	3000 K	Nero	259208	260

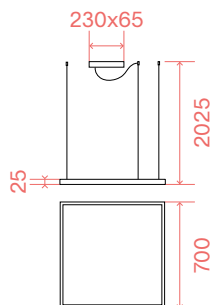

Cable length  
2500 mm

## LED SMD (DRIVER ON/OFF INCLUSO)

DIMENSIONI	PESO	VOLUME	POTENZA	DRIVER	LUMEN	CCT	FINITURA	CODICE	€
700 x 700	2,000 Kg	0,0819 m <sup>3</sup>	44 W	On-Off	4350 lm	3000 K	Bianco	259178	245
700 x 700	2,000 Kg	0,0819 m <sup>3</sup>	44 W	On-Off	4350 lm	3000 K	Nero	259185	245

# ORACLE SLIM

## SOSPENSIONE

 IP20 DURATA LED: 50.000 h

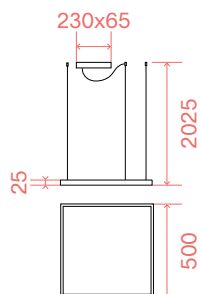

### LED SMD (DRIVER ON/OFF INCLUSO)

DIMENSIONI	PESO	VOLUME	POTENZA	DRIVER	LUMEN	CCT	FINITURA	CODICE	€
500 x 500	1,730 Kg	0,0422 m <sup>3</sup>	33 W	On-Off	3050 lm	3000 K	Bianco	259154	205
500 x 500	1,730 Kg	0,0422 m <sup>3</sup>	33 W	On-Off	3050 lm	3000 K	Nero	259161	205

Lunghezza cavo  
2500 mm

## DA SOFFITTO

 IP20 DURATA LED: 50.000 h

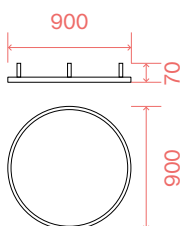

FINITURA	CCT	CODICE	€
Bianco	2700 K	341972	295
Bianco	3000 K	266015	295
Bianco	4000 K	341996	295
Nero	2700 K	341965	295
Nero	3000 K	266022	295
Nero	4000 K	341989	295

1,700 Kg  
0,1345 m<sup>3</sup>  
LED 53W  
5150/5350 lm

 Sorgente luminosa LED  
2700/3000/4000 K, 50.000 h  
di durata.

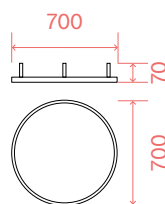

FINITURA	CCT	CODICE	€
Bianco	2700 K	341934	260
Bianco	3000 K	265995	260
Bianco	4000 K	341958	260
Nero	2700 K	341927	260
Nero	3000 K	266008	260
Nero	4000 K	341941	260

1,430 Kg  
0,0852 m<sup>3</sup>  
LED 37W  
3800/4350 lm

 Sorgente luminosa LED  
2700/3000/4000 K, 50.000 h  
di durata.

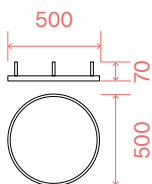

FINITURA	CCT	CODICE	€
Bianco	2700 K	341897	195
Bianco	3000 K	265971	195
Bianco	4000 K	341910	195
Nero	2700 K	341880	195
Nero	3000 K	265988	195
Nero	4000 K	341903	195

1,240 Kg  
0,0455 m<sup>3</sup>  
LED 29W  
2850/3400 lm

 Sorgente luminosa LED  
2700/3000/4000 K, 50.000 h  
di durata.

## SOSPENSIONE

□ IP20 ↑ FOTO p. 88

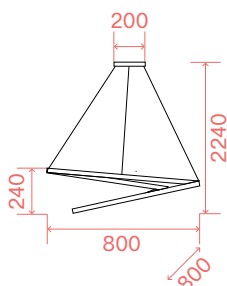

1,900 Kg  
0,0607 m<sup>3</sup>  
LED 52W  
6000/6500 lm

LED 55W / 6100 lm

### ON-OFF

FINITURA	CCT	CODICE	€
Bianco	2700 K	342405	295
Bianco	3000 K	253664	295
Bianco	4000 K	342436	295
Nero	2700 K	342412	295
Nero	3000 K	269450	295
Nero	4000 K	342443	295
Ottone	2700 K	342429	295
Ottone	3000 K	269467	295
Ottone	4000 K	342450	295

### DALI/PUSH

FINITURA	CODICE	€
Bianco	304571	470
Nero	304588	470
Ottone	304595	470

Ⓛ LED Sorgente luminosa LED  
3000 K, 30.000 h di durata.

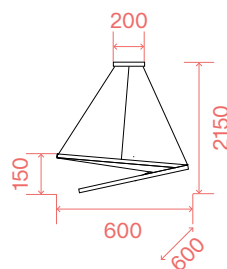

1,500 Kg  
0,0354 m<sup>3</sup>  
LED 47W  
4900/5500 lm

LED 48W / 5100 lm

### ON-OFF

FINITURA	CCT	CODICE	€
Bianco	2700 K	342344	250
Bianco	3000 K	253671	250
Bianco	4000 K	342375	250
Nero	2700 K	342351	250
Nero	3000 K	269436	250
Nero	4000 K	342382	250
Ottone	2700 K	342368	250
Ottone	3000 K	269443	250
Ottone	4000 K	342399	250

### DALI/PUSH

FINITURA	CODICE	€
Bianco	304540	390
Nero	304557	390
Ottone	304564	390

Ⓛ LED Sorgente luminosa LED  
3000 K, 30.000 h di durata.

## DA SOFFITTO

□ IP20

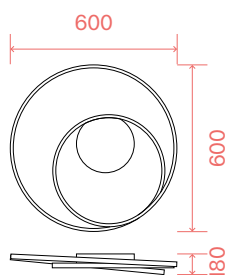

1,500 Kg  
0,0354 m<sup>3</sup>  
LED 47W  
4900/5500 lm

DALI/PUSH  
LED 48W / 5100 lm

### ON-OFF

FINITURA	CCT	CODE	€
Bianco	2700 K	342283	215
Bianco	3000 K	253688	215
Bianco	4000 K	342213	215
Nero	2700 K	342290	215
Nero	3000 K	269412	215
Nero	4000 K	342320	215
Ottone	2700 K	342306	215
Ottone	3000 K	269429	215
Ottone	4000 K	342337	215

### DALI/PUSH

FINITURA	CODICE	€
Bianco	304519	370
Nero	304526	370
Ottone	304533	370

Ⓛ LED source 3000 K,  
30.000 h life.

# OZ

DA PARETE

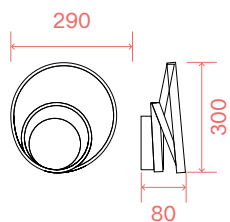

ON-OFF

FINITURA	CCT	CODICE	€
Bianco	2700 K	342221	150
Bianco	3000 K	253695	150
Bianco	4000 K	342252	150
Nero	2700 K	342238	150
Nero	3000 K	269399	150
Nero	4000 K	342269	150
Ottone	2700 K	342245	150
Ottone	3000 K	269405	150
Ottone	4000 K	342276	150

0,800 Kg  
0,0087 m<sup>3</sup>  
LED 26W  
2350/2650 lm

LED 28W / 2450 lm

DALI/PUSH

FINITURA	CODICE	€
Bianco	304489	230
Nero	304496	230
Ottone	304502	230

Sorgente luminosa LED  
3000 K, 30.000 h di durata.

DA TAVOLO



↑ FOTO p. 212

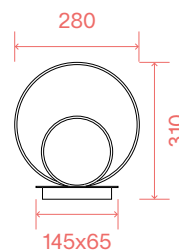

ON-OFF

FINITURA	CCT	CODICE	€
Bianco	2700 K	342467	140
Bianco	3000 K	269474	140
Bianco	4000 K	342498	140
Nero	2700 K	342474	140
Nero	3000 K	269481	140
Nero	4000 K	342504	140
Ottone	2700 K	342481	140
Ottone	3000 K	269498	140
Ottone	4000 K	342511	140

0,890 Kg  
0,0096 m<sup>3</sup>  
LED 22W  
2400/2650 lm

Sorgente luminosa LED  
2700/3000/4000 K, 30.000 h di durata.



# PERLAGE

SOSPENSIONE

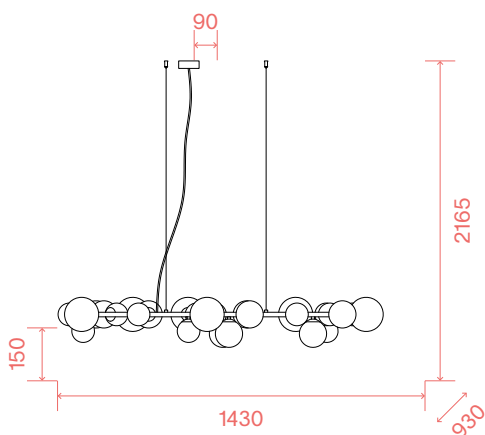

(CONSIGLIATA)

LUMEN	CCT	CODICE	€
510 lm	3000 K	305486	6

FINITURA	CODICE	€
Bianco	296746	1610
Fumè	296753	1610
Ambra	322780	1610

Lampadine LED G9 3W 3000 K  
includ. Cod. 209043

8,920 Kg  
0,2722 m<sup>3</sup>  
G9 max 30 x 15W

# PERLAGE

SOSPENSIONE

□ IP20    ↗ FOTO p. 94

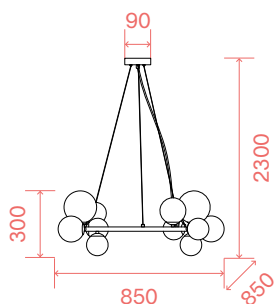

(CONSIGLIATA)

LUMEN	CCT	CODICE	€
510 lm	3000 K	305486	6
FINITURA		CODICE	€
Bianco		283814	713
Fumè		271385	713
Ambra		322797	713

Ⓛ LED Lampadine LED G9 3W 3000 K incluse. Cod. 209043

3,910 Kg  
0,0924 m<sup>3</sup>  
G9 max 14 x 15W

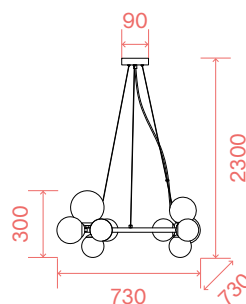

(CONSIGLIATA)

LUMEN	CCT	CODICE	€
510 lm	3000 K	305486	6
FINITURA		CODICE	€
Bianco		283807	610
Fumè		271392	610
Ambra		322773	610

Ⓛ LED Lampadine LED G9 3W 3000 K incluse. Cod. 209043

3,100 Kg  
0,0736 m<sup>3</sup>  
G9 max 11 x 15W

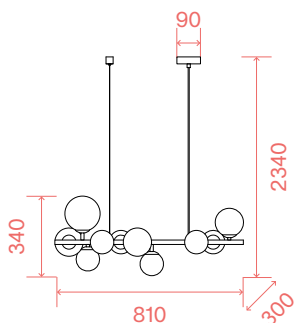

(CONSIGLIATA)

LUMEN	CCT	CODICE	€
510 lm	3000 K	305486	6
FINITURA		CODICE	€
Bianco		283791	448
Fumè		271408	448
Ambra		322766	448

Ⓛ LED Lampadine LED G9 3W 3000 K incluse. Cod. 209043

2,200 Kg  
0,0617 m<sup>3</sup>  
G9 max 10 x 15W

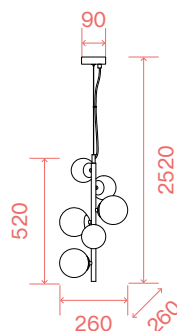

(CONSIGLIATA)

LUMEN	CCT	CODICE	€
510 lm	3000 K	305486	6
FINITURA		CODICE	€
Bianco		283821	299
Fumè		271422	299
Ambra		317793	299

Ⓛ LED Lampadine LED G9 3W 3000 K incluse. Cod. 209043

1,300 Kg  
0,0317 m<sup>3</sup>  
G9 max 6 x 15W

DA SOFFITTO

□ IP20

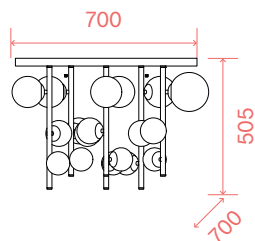

(CONSIGLIATA)

LUMEN	CCT	CODICE	€
510 lm	3000 K	305486	6
FINITURA		CODICE	€
Bianco		328393	851
Fumè		328386	851
Ambra		328379	851

Ⓛ LED Lampadine LED G9 3W 3000 K incluse. Cod. 209043

7,520 Kg  
0,1314 m<sup>3</sup>  
G9 max 18 x 15W

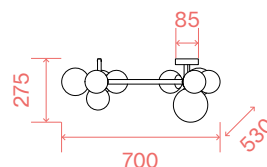

(CONSIGLIATA)

LUMEN	CCT	CODICE	€
510 lm	3000 K	305486	6
FINITURA		CODICE	€
Bianco		327815	518
Fumè		309286	518
Ambra		327808	518

Ⓛ LED Lampadine LED G9 3W 3000 K incluse. Cod. 209043

2,780 Kg  
0,0605 m<sup>3</sup>  
G9 max 10 x 15W



# PERLAGE

DA SOFFITTO

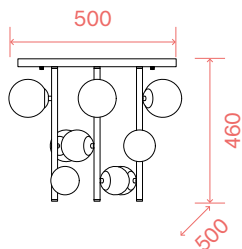

(CONSIGLIATA)

LUMEN	CCT	CODICE	€
510 lm	3000 K	305486	6

FINITURA	CODICE	€
Bianco	328423	437
Fumè	328416	437
Ambra	328409	437

3,870 Kg  
0,0622 m<sup>3</sup>  
G9 max 9 x 15W

Lampadine LED G9 3W 3000 K  
incluse. Cod. 209043

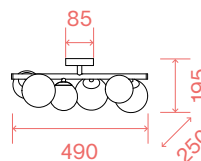

(CONSIGLIATA)

LUMEN	CCT	CODICE	€
510 lm	3000 K	305486	6

FINITURA	CODICE	€
Bianco	309279	265
Fumè	309262	265
Ambra	327822	265

1,550 Kg  
0,0385 m<sup>3</sup>  
G9 max 6 x 15W

Lampadine LED G9 3W 3000 K  
incluse. Cod. 209043

DA PARETE

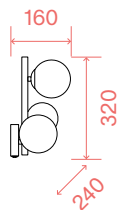

(CONSIGLIATA)

LUMEN	CCT	CODICE	€
510 lm	3000 K	305486	6

FINITURA	CODICE	€
Bianco	283784	175
Fumè	271439	175
Ambra	322742	175

0,800 Kg  
0,0173 m<sup>3</sup>  
G9 max 3 x 15W

Lampadine LED G9 3W 3000 K  
incluse. Cod. 209043

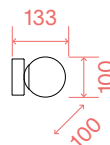

(CONSIGLIATA)

LUMEN	CCT	CODICE	€
510 lm	3000 K	305486	6

FINITURA	CODICE	€
Bianco	292410	75
Fumè	292403	75
Ambra	317809	75

0,400 Kg  
0,0062 m<sup>3</sup>  
G9 max 1 x 15W

Lampadine LED G9 3W 3000 K  
incluse. Cod. 209043

DA TAVOLO

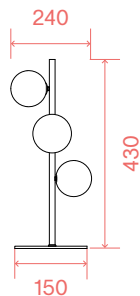

(CONSIGLIATA)

LUMEN	CCT	CODICE	€
510 lm	3000 K	305486	6

FINITURA	CODICE	€
Bianco	292472	200
Fumè	292465	200
Ambra	322759	200

2,000 Kg  
0,0227 m<sup>3</sup>  
G9 max 3 x 15W

Lampadine LED G9 3W 3000 K  
incluse. Cod. 209043

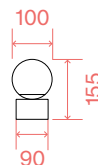

(CONSIGLIATA)

LUMEN	CCT	CODICE	€
510 lm	3000 K	305486	6

FINITURA	CODICE	€
Bianco	292458	85
Fumè	292441	85
Ambra	317823	85

0,600 Kg  
0,0062 m<sup>3</sup>  
G9 max 1 x 15W

Lampadine LED G9 3W 3000 K  
incluse. Cod. 209043



# PERLAGE

DA TERRA

IP20   FOTO p. 260

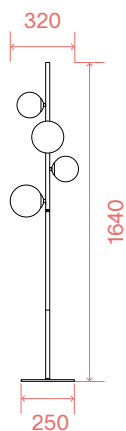

(CONSIGLIATA)

LUMEN	CCT	CODICE	€
510 lm	3000 K	305486	6

FINITURA	CODICE	€
Bianco	277967	325
Fumè	306988	325
Ambra	317816	325

 Lampadine LED G9 3W 3000 K include. Cod. 209043



4,800 Kg  
0,0612 m<sup>3</sup>  
G9 max 4 x 15W

# PIANO

DA PARETE

IP20   FOTO p. 184

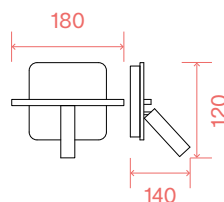

FINITURA	CODICE	€
Bianco	287317	165
Nero	287300	165

 Sorgente luminosa LED 3000 K, 20.000 h di durata.



0,800 Kg  
0,0047 m<sup>3</sup>  
LED 10W / 1150 lm



# SET UP - MONTATURE

DA SOFFITTO

IP20 

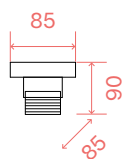

(CONSIGLIATA)

LUMEN	CCT	CODICE	€
900 lm	3000 K	123899	3,50

FINITURA	CODICE	€
Bianco	277288	35

0,300 Kg  
0,0010 m<sup>3</sup>  
E27 max 1 x 42W

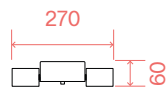

VERS. TRE LAMPADINE

Bianco	348278	58
--------	--------	----

0,850 Kg  
0,0041 m<sup>3</sup>  
E27 max 3 x 42W

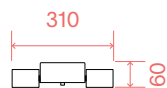

VERS. QUATTRO LAMPADINE

Bianco	320373	80
--------	--------	----

1,000 Kg  
0,0047 m<sup>3</sup>  
E27 max 4 x 42W

SOSPENSIONE

IP20 



(CONSIGLIATA)

LUMEN	CCT	CODICE	€
900 lm	3000 K	123899	3,50

FINITURA	CODICE	€
Bianco	260013	30
Nickel	260044	30
Nero	260020	30
Ottone	260051	30

0,350 Kg  
0,0019 m<sup>3</sup>  
E27 max 1 x 42W

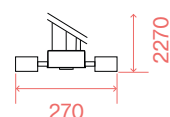

VERS. TRE LAMPADINE

Bianco	348193	102
Nickel	348209	102
Nero	348216	102
Ottone	348223	102

1,000 Kg  
0,0072 m<sup>3</sup>  
E27 max 3 x 42W

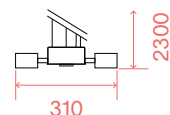

VERS. QUATTRO LAMPADINE

Bianco	348230	126
Nickel	348247	126
Nero	348254	126
Ottone	348261	126

1,200 Kg  
0,0081 m<sup>3</sup>  
E27 max 4 x 42W

# SET UP - MONTATURE

## DA PARETE



IP20



FOTO p. 188

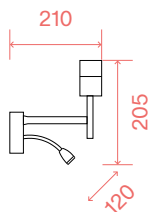

(CONSIGLIATA)

LUMEN	CCT	CODICE	€
900 lm	3000 K	123899	3,50

FINITURA CODICE €

Bianco 259819 133

Nickel 259833 133

Nero 259826 133

Ottone 259857 133

0,900 Kg  
0,0063 m<sup>3</sup>  
LED 3W / 200 lm



Sorgente luminosa LED 3000 K  
20.000 h di durata.

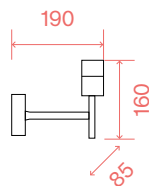

(CONSIGLIATA)

LUMEN	CCT	CODICE	€
900 lm	3000 K	123899	3,50

FINITURA CODICE €

Bianco 259765 63

Nickel 259796 63

Nero 259772 63

Ottone 259802 63

0,370 Kg  
0,0032 m<sup>3</sup>  
E27 max 1 x 42W

## DA TAVOLO



IP20



FOTO p. 220

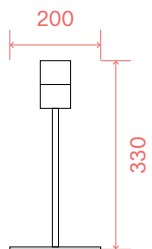

(CONSIGLIATA)

LUMEN	CCT	CODICE	€
900 lm	3000 K	123899	3,50

FINITURA CODICE €

Bianco 259918 90

Nickel 259949 90

Nero 259925 90

Ottone 259956 90

1,130 Kg  
0,0055 m<sup>3</sup>  
E27 max 1 x 42W

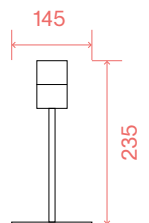

(CONSIGLIATA)

LUMEN	CCT	CODICE	€
900 lm	3000 K	123899	3,50

FINITURA CODICE €

Bianco 259864 70

Nickel 259895 70

Nero 259871 70

Ottone 259901 70

0,680 Kg  
0,0061 m<sup>3</sup>  
E27 max 1 x 42W

## DA TERRA



IP20



FOTO p. 266

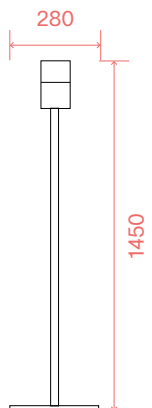

(CONSIGLIATA)

LUMEN	CCT	CODICE	€
900 lm	3000 K	123899	3,50

FINITURA CODICE €

Bianco 259963 166

Nickel 259994 166

Nero 259970 166

Ottone 260006 166

2,640 Kg  
0,0251 m<sup>3</sup>  
E27 max 1 x 42W

# SET UP - PARALUMI

## SET UP

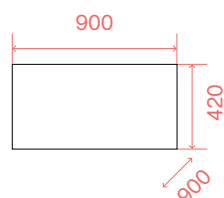

2,000 Kg  
0,1384 m<sup>3</sup>

(SOLO PER VERS. SOSPENSIONE,  
DA SOFFITTO)

FINITURA	CODICE	€
Bianco	345918	172
Tortora	345932	172
Nero	345925	172
Beige	339269	172
Legno	339276	172

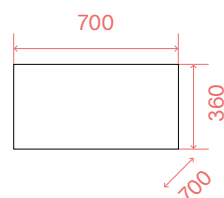

1,260 Kg  
0,0674 m<sup>3</sup>

(SOLO PER VERS. SOSPENSIONE,  
DA SOFFITTO)

FINITURA	CODICE	€
Bianco	260471	138
Tortora	304632	138
Nero	270029	138
Beige	260488	138
Legno	345901	138

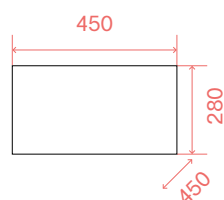

0,770 Kg  
0,0221 m<sup>3</sup>

(SOLO PER VERS. SOSPENSIONE,  
DA SOFFITTO, DA TERRA)

FINITURA	CODICE	€
Bianco	260457	92
Tortora	304625	92
Nero	270012	92
Beige	260464	92
Legno	345895	92

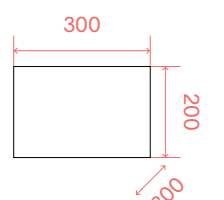

0,460 Kg  
0,0228 m<sup>3</sup>

(SOLO PER VERS. DA SOFFITTO,  
DA PARETE, DA TAVOLO)

FINITURA	CODICE	€
Bianco	260433	63
Tortora	304618	63
Nero	270005	63
Beige	260440	63
Legno	345888	63

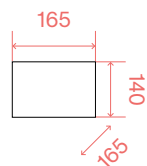

0,120 Kg  
0,0018 m<sup>3</sup>

(SOLO PER VERS. DA PARETE,  
DA TAVOLO)

FINITURA	CODICE	€
Bianco	260327	32
Tortora	304601	32
Nero	269986	32
Beige	260334	32
Legno	345871	32

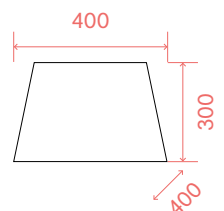

0,460 Kg  
0,0709 m<sup>3</sup>

(SOLO PER VERS. DA TERRA)

FINITURA	CODICE	€
Bianco	260136	75
Tortora	304120	75
Nero	260235	75
Beige	260242	75
Legno	345963	75

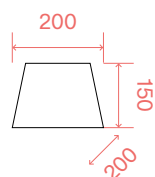

0,130 Kg  
0,0180 m<sup>3</sup>

(SOLO PER VERS. DA PARETE,  
DA TAVOLO)

FINITURA	CODICE	€
Bianco	260068	34
Tortora	304113	34
Nero	260075	34
Beige	260082	34
Legno	345956	34

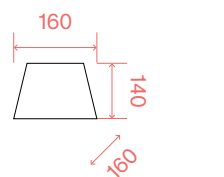

0,110 Kg  
0,0180 m<sup>3</sup>

(SOLO PER VERS. DA PARETE,  
DA TAVOLO)

FINITURA	CODICE	€
Bianco	260341	29
Tortora	293004	29
Nero	270036	29
Beige	260358	29
Legno	345949	29

# SET UP - PARALUMI

## SET UP SLIM

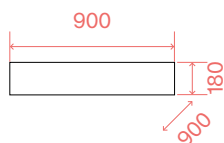

(SOLO PER VERS. SOSPENSIONE, DA SOFFITTO)

FINITURA	CODICE	€
Bianco	346069	138
Tortora	339283	138
Nero	346083	138
Beige	346052	138
Legno	346076	138

1,200 Kg  
0,1903 m<sup>3</sup>

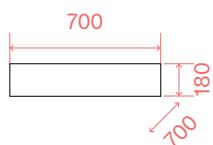

(SOLO PER VERS. SOSPENSIONE, DA SOFFITTO)

FINITURA	CODICE	€
Bianco	339290	115
Tortora	346045	115
Nero	346038	115
Beige	346014	115
Legno	346021	115

0,750 Kg  
0,1172 m<sup>3</sup>

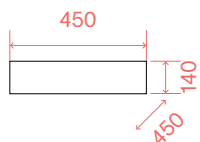

(SOLO PER VERS. SOSPENSIONE, DA SOFFITTO)

FINITURA	CODICE	€
Bianco	345987	80
Tortora	346007	80
Nero	345994	80
Beige	345970	80
Legno	339306	80

0,440 Kg  
0,0415 m<sup>3</sup>

## SET UP ULTRASLIM

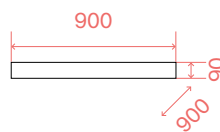

(SOLO PER VERS. SOSPENSIONE, DA SOFFITTO)

FINITURA	CODICE	€
Bianco	346182	126
Tortora	346205	126
Nero	339313	126
Beige	346175	126
Legno	346199	126

0,800 Kg  
0,1124 m<sup>3</sup>

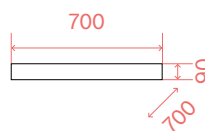

(SOLO PER VERS. SOSPENSIONE, DA SOFFITTO)

FINITURA	CODICE	€
Bianco	346144	103
Tortora	346168	103
Nero	346151	103
Beige	346137	103
Legno	339320	103

0,600 Kg  
0,0613 m<sup>3</sup>

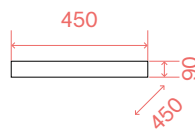

(SOLO PER VERS. SOSPENSIONE, DA SOFFITTO)

FINITURA	CODICE	€
Bianco	339337	69
Tortora	346120	69
Nero	346113	69
Beige	346090	69
Legno	346106	69

0,500 Kg  
0,0265 m<sup>3</sup>

## DISCHI ACRILICI

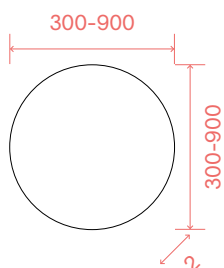

(SOLO PER VERS. SOSPENSIONE, DA SOFFITTO)

LAMPADINE	FINITURA	MISURE	PESO	VOLUME	CODICE	€
	Trasparen.	(D90)	0,500 Kg	0,0423 m <sup>3</sup>	339252	80
	Trasparen.	(D70)	0,700 Kg	0,0259 m <sup>3</sup>	270050	58
	Trasparen.	(D45)	0,280 Kg	0,0108 m <sup>3</sup>	270043	35
	Trasparen.	(D30)	0,100 Kg	0,0061 m <sup>3</sup>	346847	17

# SMARTIES

SOSPENSIONE



IP20



FOTO p. 100

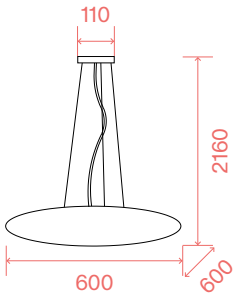

(CONSIGLIATA)

LUMEN	CCT	CODICE	€
340 lm	3000 K	101286	2
FINITURA		CODICE	€
Bianco		031996	290

5,280 Kg  
0,1479 m<sup>3</sup>  
E27 max 5 x 42W

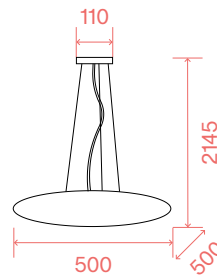

(CONSIGLIATA)

LUMEN	CCT	CODICE	€
340 lm	3000 K	101286	2
FINITURA		CODICE	€
Bianco		032009	200

3,740 Kg  
0,1009 m<sup>3</sup>  
E27 max 3 x 42W

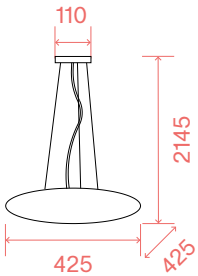

(CONSIGLIATA)

LUMEN	CCT	CODICE	€
340 lm	3000 K	101286	2
FINITURA		CODICE	€
Bianco		032016	175

2,930 Kg  
0,0645 m<sup>3</sup>  
E27 max 3 x 42W

DA SOFFITTO



IP20

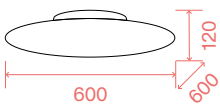

(CONSIGLIATA)

LUMEN	CCT	CODICE	€
340 lm	3000 K	101286	2
FINITURA		CODICE	€
Bianco		032023	280

4,690 Kg  
0,1480 m<sup>3</sup>  
E27 max 3 x 42W

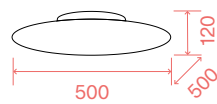

(CONSIGLIATA)

LUMEN	CCT	CODICE	€
340 lm	3000 K	101286	2
FINITURA		CODICE	€
Bianco		032030	195

3,070 Kg  
0,1009 m<sup>3</sup>  
E27 max 3 x 42W

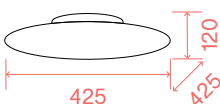

(CONSIGLIATA)

LUMEN	CCT	CODICE	€
340 lm	3000 K	101286	2
FINITURA		CODICE	€
Bianco		032047	170

2,810 Kg  
0,0599 m<sup>3</sup>  
E27 max 2 x 42W

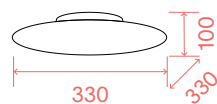

(CONSIGLIATA)

LUMEN	CCT	CODICE	€
340 lm	3000 K	101286	2
FINITURA		CODICE	€
Bianco		009223	115

1,440 Kg  
0,0454 m<sup>3</sup>  
E27 max 1 x 42W

# SMARTIES

DA PARETE / SOFFITTO  IP20

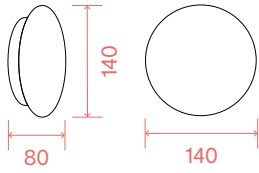

(CONSIGLIATA)

LUMEN	CCT	CODICE	€
510 lm	3000 K	305486	6

FINITURA	CODICE	€
Bianco	014814	46

0,440 Kg  
0,0079 m<sup>3</sup>  
G9 max 1 x 15W

 Lampadine LED G9 3W 3000 K include. Cod. 209043

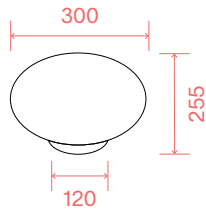

(CONSIGLIATA)

LUMEN	CCT	CODICE	€
430 lm	3000 K	101279	2

FINITURA	CODICE	€
Bianco	327907	130

1,400 Kg  
0,0392 m<sup>3</sup>  
E27 max 1 x 42W



DA TAVOLO  IP20

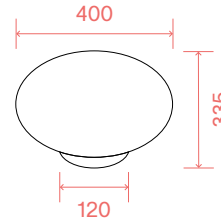

(CONSIGLIATA)

LUMEN	CCT	CODICE	€
430 lm	3000 K	101279	2

FINITURA	CODICE	€
Bianco	827914	190

2,660 Kg  
0,0810 m<sup>3</sup>  
E27 max 1 x 42W

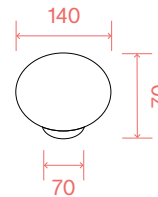

(CONSIGLIATA)

LUMEN	CCT	CODICE	€
510 lm	3000 K	305486	6

FINITURA	CODICE	€
Bianco	032078	50

0,470 Kg  
0,0079 m<sup>3</sup>  
G9 max 1 x 15W

 Lampadine LED G9 3W 3000 K include. Cod. 209043



# SPIKE

DA SOFFITTO  IP20  FOTO p. 138

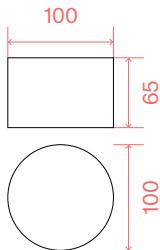

(CONSIGLIATA)

LUMEN	CCT	CODICE	€
910 lm	3000 K	123936	5

FINITURA	CODICE	€
Bianco	277417	80
Cromo	310886	80
Nero	278704	80
Ottone	285238	80
Rame	310893	80

0,240 Kg  
0,0017 m<sup>3</sup>  
GX53 max 1 x 15W

 Lampadine LED GX53 9W 3000 K include. Cod. 123936

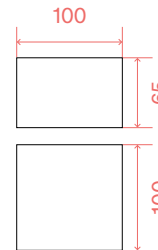

(CONSIGLIATA)

LUMEN	CCT	CODICE	€
910 lm	3000 K	123936	5

FINITURA	CODICE	€
Bianco	317489	85
Cromo	328799	85
Nero	317496	85
Ottone	317502	85
Rame	328812	85

0,220 Kg  
0,0014 m<sup>3</sup>  
GX53 max 1 x 15W

 Lampadine LED GX53 9W 3000 K include. Cod. 123936

# SPIKE LED

DA SOFFITTO



IP20

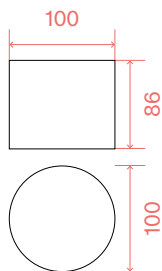

FINITURA	CODICE	€
Bianco	345468	40
Nero	336008	40
Ottone	345475	40

Sorgente luminosa LED  
3000 K, 25.000 h di durata.

0,340 Kg  
0,0012 m<sup>3</sup>  
LED 10W / 1100 lm

# ULTRATHIN

SOSPENSIONE



IP20

↑ FOTO p. 106



ON-OFF

FINITURA	CODICE	€
Bianco	142906	143
Cromo	164878	143
Nero	142913	143
Ottone	339733	143

DALI/PUSH

FINITURA	CODICE	€
Nero	321783	205

Sorgente luminosa LED  
3000 K, 30.000 h di durata.

0,670 Kg  
0,0036 m<sup>3</sup>  
LED 11,5W / 1150 lm  
51°

DALI/PUSH  
1,100 Kg  
0,0070 m<sup>3</sup>  
LED 12W / 1150 lm

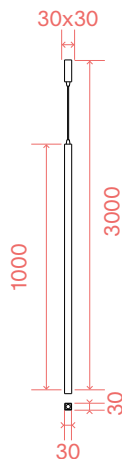

ON-OFF

FINITURA	CODICE	€
Bianco	194172	209
Nero	194196	209
Ottone	339757	209

Sorgente luminosa LED  
3000 K, 30.000 h di durata.

0,860 Kg  
0,0036 m<sup>3</sup>  
LED 11,5W / 1150 lm / 51°



# ULTRATHIN

SOSPENSIONE

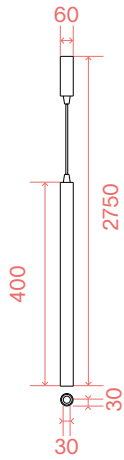

ON-OFF

FINITURA	CODICE	€
Bianco	156682	108
Cromo	187662	108
Nero	156699	108
Ottone	339726	108

DALI/PUSH

FINITURA	CODICE	€
Nero	321813	176

Sorgente luminosa LED  
3000 K, 30.000 h di durata.

0,460 Kg  
0,0036 m<sup>3</sup>  
LED 11,5W / 1150 lm  
51°

DALI/PUSH  
0,760 Kg  
0,0037 m<sup>3</sup>  
LED 12W / 1150 lm

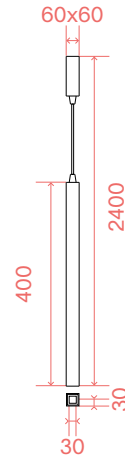

ON-OFF

FINITURA	CODICE	€
Bianco	194189	170
Nero	194202	170
Ottone	339740	170

Sorgente luminosa LED  
3000 K, 30.000 h di durata.

0,450 Kg  
0,0019 m<sup>3</sup>  
LED 11,5W / 1150 lm / 51°

# ZIG ZAG

DA PARETE

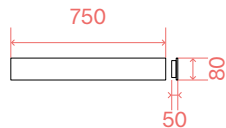

FINITURA	CCT	CODICE	€
Bianco	2700 K	342665	140
Bianco	3000 K	277219	140
Bianco	4000 K	277257	140
Nero	3000 K	277226	140
Ottone	3000 K	287072	140

Sorgente luminosa LED  
2700/3000/4000 K, 50.000 h di durata.

1,040 Kg  
0,0047 m<sup>3</sup>  
LED 30W  
2950/4550 lm

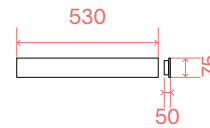

FINITURA	CCT	CODICE	€
Bianco	2700 K	342658	110
Bianco	3000 K	179308	110
Bianco	4000 K	277240	110
Nero	3000 K	179322	110
Ottone	3000 K	282138	110

Sorgente luminosa LED  
2700/3000/4000 K, 50.000 h di durata.

0,760 Kg  
0,0034 m<sup>3</sup>  
LED 23W  
2800/3200 lm

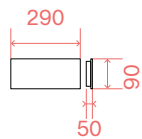

FINITURA	CCT	CODICE	€
Bianco	2700 K	342641	95
Bianco	3000 K	179292	95
Bianco	4000 K	277233	95
Nero	3000 K	179315	95
Ottone	3000 K	282121	95

Sorgente luminosa LED  
2700/3000/4000 K, 50.000 h di durata.

0,550 Kg  
0,0020 m<sup>3</sup>  
LED 12,5W  
1450/1600 lm

# DEVA TRACK

SISTEMI



IP20 MacAdam: SDCM 3 CRI: ≥90 DURATA LED: 30.000 h

↑ FOTO p. 272

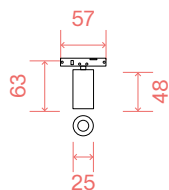

0,030 Kg  
0,0002 m<sup>3</sup>

## LED SMD

POTENZA	ANGOLO	CONTROLLO	LUMEN	CCT	FINITURA	CODICE	€
2,5 W	37°	On-Off	150 lm	3000 K	Bianco	332772	35
2,5 W	37°	On-Off	150 lm	3000 K	Nero	332765	35

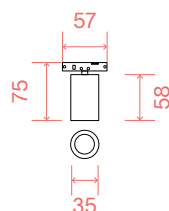

0,050 Kg  
0,0003 m<sup>3</sup>

## LED COB

POTENZA	ANGOLO	CONTROLLO	LUMEN	CCT	FINITURA	CODICE	€
4,5 W	34°	On-Off	450 lm	3000 K	Bianco	332796	40
4,5 W	34°	On-Off	450 lm	3000 K	Nero	332789	40

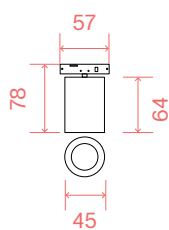

0,090 Kg  
0,0004 m<sup>3</sup>

## LED COB

POTENZA	ANGOLO	CONTROLLO	LUMEN	CCT	FINITURA	CODICE	€
8 W	30°	On-Off	750 lm	3000 K	Bianco	332826	45
8 W	30°	On-Off	750 lm	3000 K	Nero	332819	45

## LENS

NECESSARIO	ANGOLO	MODELLO	CODICE	€
No	15°	DEVA 2,5 W	332543	5
No	15°	DEVA 4,5 W	332505	5
No	15°	DEVA 8 W	332468	5

# DEVA DISC

SISTEMI



IP20 MacAdam: SDCM 3 CRI: ≥90 DURATA LED: 30.000 h

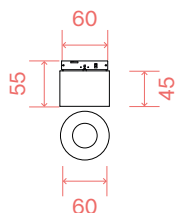

## LED COB BRIDGELUX

POTENZA	ANGOLO	CONTROLLO	LUMEN	CCT	FINITURA	CODICE	€
5 W	38°	On-Off	500 lm	3000 K	Bianco	332857	40
5 W	38°	On-Off	500 lm	3000 K	Nero	332840	40

0,110 Kg  
0,0004 m<sup>3</sup>

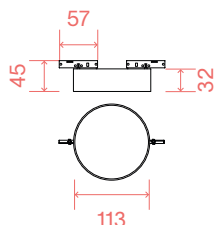

## LED SMD

POTENZA	ANGOLO	CONTROLLO	LUMEN	CCT	FINITURA	CODICE	€
10 W	98°	On-Off	1100 lm	3000 K	Bianco	332888	45
10 W	98°	On-Off	1100 lm	3000 K	Nero	332864	45

0,330 Kg  
0,0020 m<sup>3</sup>

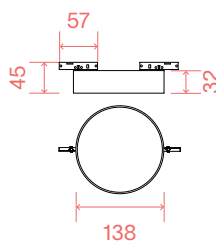

## LED SMD

POTENZA	ANGOLO	CONTROLLO	LUMEN	CCT	FINITURA	CODICE	€
15 W	98°	On-Off	1750 lm	3000 K	Bianco	332918	55
15 W	98°	On-Off	1750 lm	3000 K	Nero	332901	55

0,430 Kg  
0,0020 m<sup>3</sup>

# DEVA ACCENT

## SISTEMI



IP20 MacAdam: SDCM 3 CRI: ≥90 DURATA LED: 30.000 h

0,070 Kg  
0,0002 m<sup>3</sup>

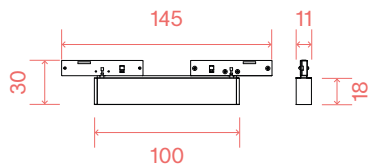

### LED SMD

POTENZA	ANGOLO	LUMEN	CCT	FINITURA	CODICE	€
5 W	34°	350 lm	3000 K	Nero	332758	30

0,140 Kg  
0,0003 m<sup>3</sup>

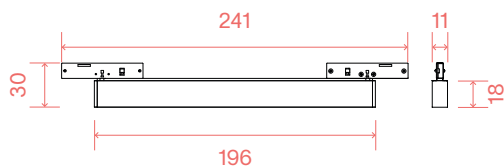

### LED SMD

POTENZA	ANGOLO	LUMEN	CCT	FINITURA	CODICE	€
10 W	34°	900 lm	3000 K	Nero	332734	40

0,230 Kg  
0,0005 m<sup>3</sup>

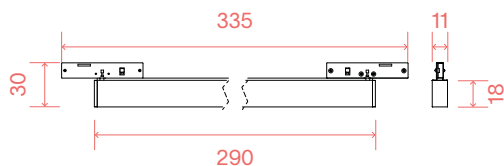

### LED SMD

POTENZA	ANGOLO	LUMEN	CCT	FINITURA	CODICE	€
14 W	34°	1400 lm	3000 K	Nero	332710	50

# DEVA WIDE INNER

## SISTEMI



IP20 MacAdam: SDCM 3 CRI:  $\geq 90$  DURATA LED: 30.000 h

0,020 Kg  
0,0001 m<sup>3</sup>

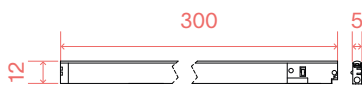

### LED SMD

POTENZA	ANGOLO	LUMEN	CCT	FINITURA	CODICE	€
6 W	100°	700 lm	3000 K	Nero	332949	25

0,080 Kg  
0,0003 m<sup>3</sup>

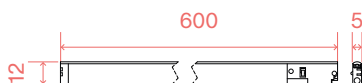

### LED SMD

POTENZA	ANGOLO	LUMEN	CCT	FINITURA	CODICE	€
11 W	100°	1400 lm	3000 K	Nero	332925	35

0,130 Kg  
0,0004 m<sup>3</sup>

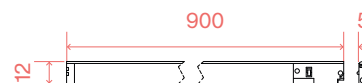

### LED SMD

POTENZA	ANGOLO	LUMEN	CCT	FINITURA	CODICE	€
16 W	100°	2100 lm	3000 K	Nero	332895	50

# DEVA WIDE OUTER

## SISTEMI



IP20 MacAdam: SDCM 3 CRI: ≥90 DURATA LED: 30.000 h

0,130 Kg  
0,0005 m<sup>3</sup>

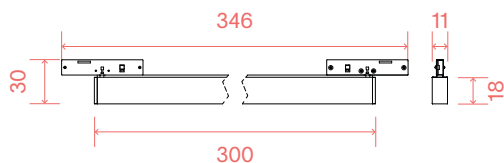

### LED SMD

POTENZA	ANGOLO	LUMEN	CCT	FINITURA	CODICE	€
8 W	100°	900 lm	3000 K	Nero	332871	25

0,330 Kg  
0,0008 m<sup>3</sup>

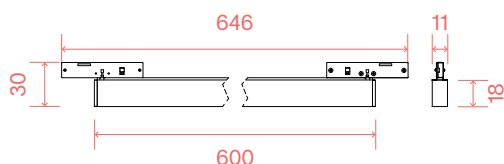

### LED SMD

POTENZA	ANGOLO	LUMEN	CCT	FINITURA	CODICE	€
12 W	100°	1350 lm	3000 K	Nero	332833	35

0,310 Kg  
0,0012 m<sup>3</sup>

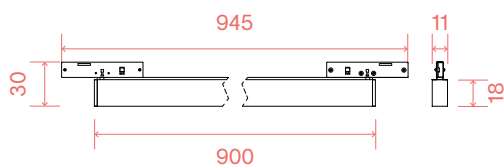

### LED SMD

POTENZA	ANGOLO	LUMEN	CCT	FINITURA	CODICE	€
21 W	100°	2700 lm	3000 K	Nero	332802	50

# DEVA PENDANT

## SISTEMI



IP20 MacAdam: SDCM 3 CRI:  $\geq 90$  DURATA LED: 30.000 h

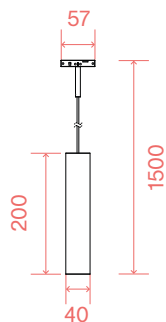

## LED COB

POTENZA	ANGOLO	LUMEN	CCT	FINITURA	CODICE	€
6 W	34°	550 lm	3000 K	Nero	332932	45

0,280 Kg  
0,0009 m<sup>3</sup>

# DEVA - SURFACE

## SISTEMI

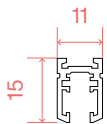

### PROFILE SURFACE

LUNGHEZZA	PESO	VOLUME	FINITURA	CODICE	€
1000 mm	0,280 Kg	0,0003 m <sup>3</sup>	Nero	332475	20
2000 mm	0,470 Kg	0,0007 m <sup>3</sup>	Nero	332482	40

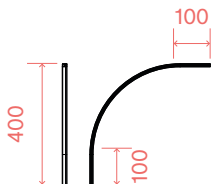

### SURFACE CORNER ROUND

PESO	VOLUME	CONTROLLO	FINITURA	CODICE	€
0,1700 Kg	0,0014 m <sup>3</sup>	On-Off	Nero	339375	91

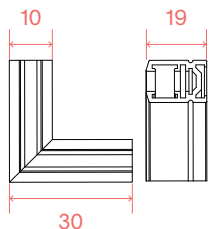

### SURFACE CORNER L

PESO	VOLUME	CONTROLLO	FINITURA	CODICE	€
0,020 Kg	0,0004 m <sup>3</sup>	On-Off	Nero	339382	41



### LINEAR CONNECTOR (NECESSARIO - 1 KIT X GIUNZIONE LINEARE)

PESO	VOLUME	CONTROLLO	FINITURA	CODICE	€
0,010 Kg	0,0005 m <sup>3</sup>	On-Off	Nero	339368	18

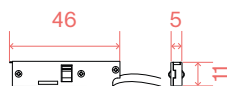

### MAIN CONNECTOR (NECESSARIO - 1 KIT X PUNTO DI ALIMENTAZ. MAX 140W)

PESO	VOLUME	CONTROLLO	FINITURA	CODICE	€
0,060 Kg	0,0002 m <sup>3</sup>	On-Off	Nero	332581	15

Lunghezza cavo 1500 mm

### DRIVER ON/OFF (NECESSARIO)

POTENZA	OUTPUT	MISURA (L X H X P)	CODICE	€
75 W	24 Vdc	168 x 30 x 38 mm	332659	65
150 W	24 Vdc	227 x 30 x 38 mm	332628	95

	NECESSARIO	MISURA (L X H X P)	FINITURA	CODICE	€
END CAP (2 pcs. incl.)	SI	10 x 15 x 7 mm	Nero	332635	3
KIT PENDANT	SI	7,7 x 2049 x 7 mm	Nero	332703	15



# DEVA - SURFACE - ASSEMBLY PLANS

## SISTEMI

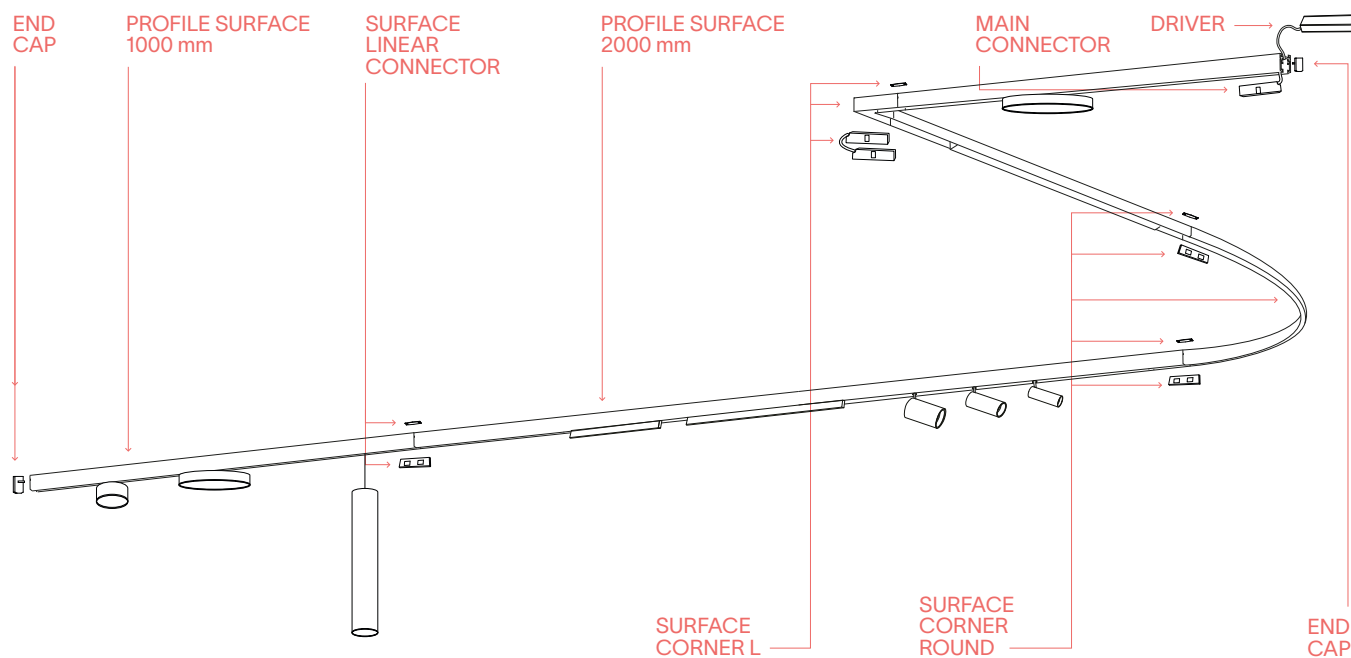
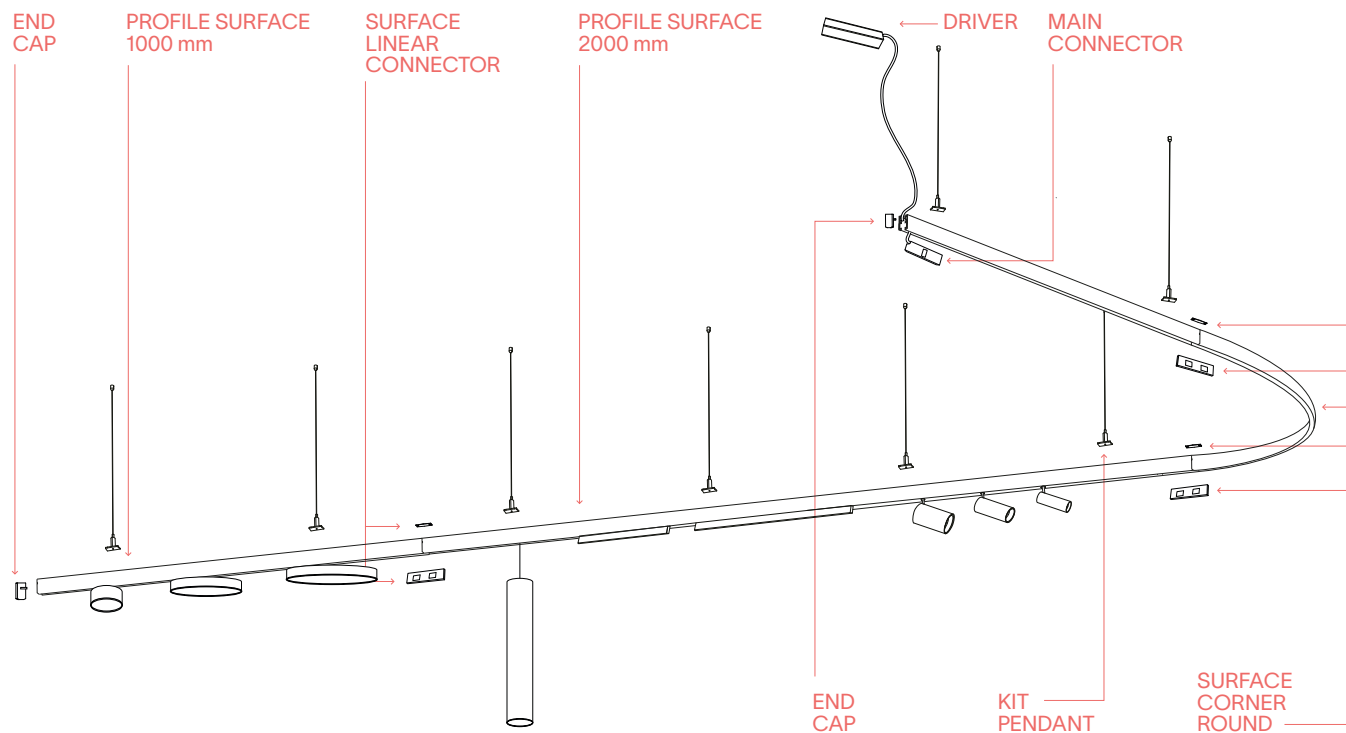

# DEVA - RECESSED

## SISTEMI

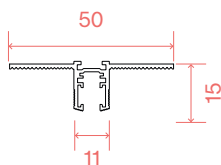

### PROFILE RECESSED

LUNGHEZZA	PESO	VOLUME	FINITURA	CODICE	€
1000 mm	0,370 Kg	0,0017 m <sup>3</sup>	Nero	332529	20
2000 mm	0,670 Kg	0,0034 m <sup>3</sup>	Nero	332536	40

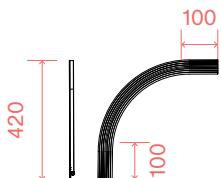

### RECESSED CORNER ROUND

PESO	VOLUME	CONTROLLO	FINITURA	CODICE	€
0,270 Kg	0,0023 m <sup>3</sup>	On-Off	Nero	339405	91

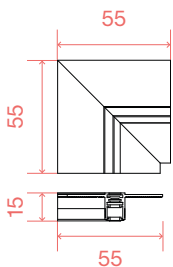

### RECESSED CORNER L

PESO	VOLUME	CONTROLLO	FINITURA	CODICE	€
0,030 Kg	0,0003 m <sup>3</sup>	On-Off	Nero	339412	41



### RECESSED LINEAR CONNECTOR (NECESSARIO - 1 KIT X GIUNZIONE LINEARE)

PESO	VOLUME	CONTROLLO	FINITURA	CODICE	€
0,020 Kg	0,0005 m <sup>3</sup>	On-Off	Nero	339399	18

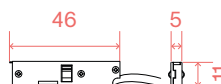

### MAIN CONNECTOR (NECESSARIO - 1 KIT X PUNTO DI ALIMENTAZ. MAX 140W)

PESO	VOLUME	CONTROLLO	FINITURA	CODICE	€
0,060 Kg	0,0002 m <sup>3</sup>	On-Off	Nero	332581	15

Lunghezza cavo 1500 mm

### DRIVER ON/OFF (NECESSARIO)

POTENZA	OUTPUT	MISURA (L X H X P)	CODICE	€
75 W	24 Vdc	168 x 30 x 38 mm	332659	65
150 W	24 Vdc	227 x 30 x 38 mm	332628	95

	NECESSARIO	MISURA (L X H X P)	FINITURA	CODICE	€
END CAP (2 pcs. incl.)	SI	10 x 15 x 7 mm	Nero	332635	3

# DEVA - RECESSED - ASSEMBLY PLANS

## SISTEMI

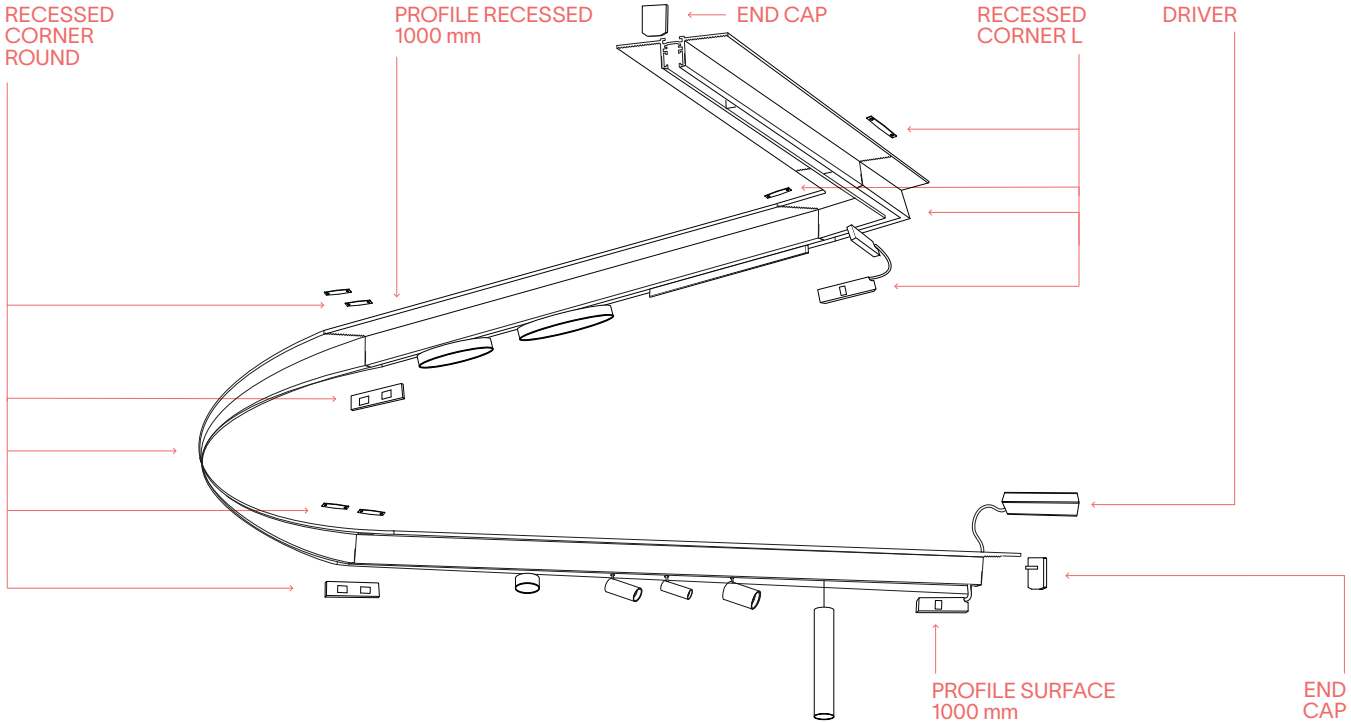

# DEVA - RECESSED EASY

## SISTEMI

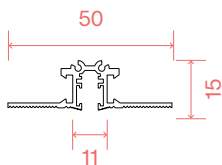

### PROFILE RECESSED EASY

LUNGHEZZA	PESO	VOLUME	FINITURA	CODICE	€
1000 mm	0,370 Kg	0,0017 m <sup>3</sup>	Nero	332499	25
2000 mm	0,870 Kg	0,0034 m <sup>3</sup>	Nero	332512	50

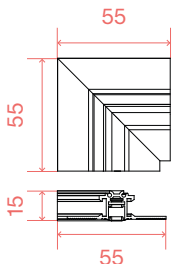

### RECESSED EASY CORNER L

PESO	VOLUME	CONTROLLO	FINITURA	CODICE	€
0,030 Kg	0,0003 m <sup>3</sup>	On-Off	Nero	339429	41



### RECESSED LINEAR CONNECTOR (NECESSARIO - 1 KIT X GIUNZIONE LINEARE)

PESO	VOLUME	CONTROLLO	FINITURA	CODICE	€
0,020 Kg	0,0005 m <sup>3</sup>	On-Off	Nero	339399	18

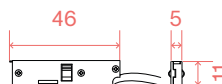

### MAIN CONNECTOR (NECESSARIO - 1 KIT X PUNTO DI ALIMENTAZ. MAX 140W)

PESO	VOLUME	CONTROLLO	FINITURA	CODICE	€
0,060 Kg	0,0002 m <sup>3</sup>	On-Off	Nero	332581	15

Lunghezza cavo 1500 mm

### DRIVER ON/OFF (NECESSARIO)

POTENZA	OUTPUT	MISURA (L X H X P)	CODICE	€
75 W	24 Vdc	168 x 30 x 38 mm	332659	65
150 W	24 Vdc	227 x 30 x 38 mm	332628	95

	NECESSARIO	MISURA (L X H X P)	FINITURA	CODICE	€
END CAP (2 pcs. incl.)	SI	10 x 15 x 7 mm	Nero	332635	3

# DEVA - RECESSED EASY - ASSEMBLY PLANS

## SISTEMI

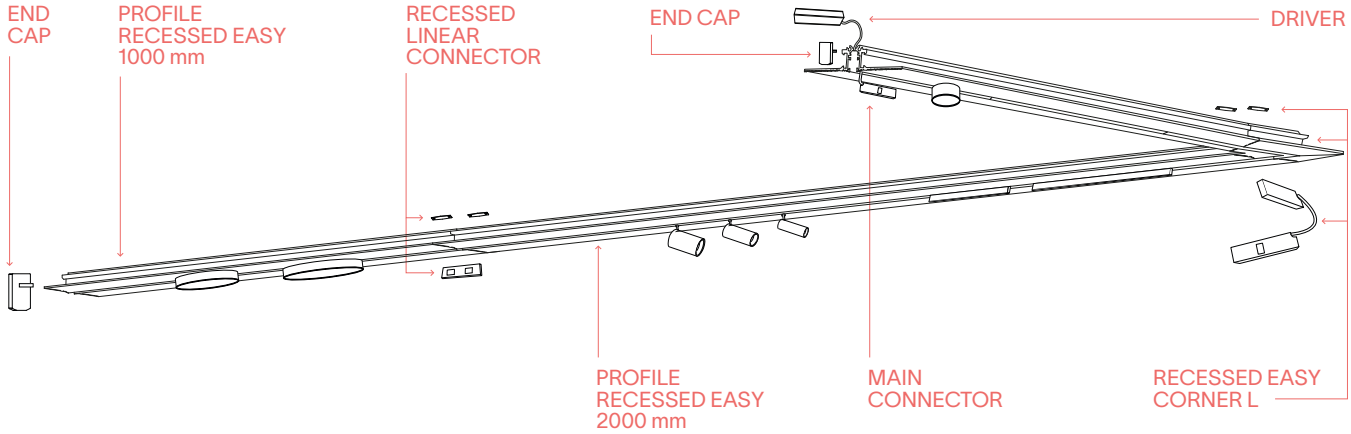

# DISPLAY ACCENT

PROIETTORI

↑ IP20 MacAdam: SDCM 3 UGR: <16 CRI: ≥90 DURATA LED: 50.000 h (PRO)

↑ FOTO p. 285

0,750 Kg  
0,0055 m<sup>3</sup>



LED SMD SAMSUNG (DRIVER ON/OFF INCLUSO)

POTENZA	ANGOLO	LUMEN	CCT	BINARIO	FINITURA	CODICE	€
14 W	60°	1250 lm	2700 K	3-Phase	Bianco	339894	242
14 W	60°	1250 lm	2700 K	3-Phase	Nero	339887	242
14 W	60°	1350 lm	3000 K	3-Phase	Bianco	283593	242
14 W	60°	1350 lm	3000 K	3-Phase	Nero	283609	242
14 W	60°	1600 lm	4000 K	3-Phase	Bianco	283616	242
14 W	60°	1600 lm	4000 K	3-Phase	Nero	283623	242

1,120 Kg  
0,0112 m<sup>3</sup>



LED SMD SAMSUNG (DRIVER ON/OFF INCLUSO)

POTENZA	ANGOLO	LUMEN	CCT	BINARIO	FINITURA	CODICE	€
28 W	60°	2700 lm	3000 K	3-Phase	Bianco	283524	380
28 W	60°	2700 lm	3000 K	3-Phase	Nero	276267	380
28 W	60°	3200 lm	4000 K	3-Phase	Bianco	283531	380
28 W	60°	3200 lm	4000 K	3-Phase	Nero	283548	380

1,570 Kg  
0,0173 m<sup>3</sup>



LED SMD SAMSUNG (DRIVER ON/OFF INCLUSO)

POTENZA	ANGOLO	LUMEN	CCT	BINARIO	FINITURA	CODICE	€
42 W	60°	3750 lm	3000 K	3-Phase	Bianco	283555	525
42 W	60°	3750 lm	3000 K	3-Phase	Nero	283562	525
42 W	60°	4350 lm	4000 K	3-Phase	Bianco	283579	525
42 W	60°	4350 lm	4000 K	3-Phase	Nero	283586	525

# DISPLAY WIDE

PROIETTORI



IP20 MacAdam: SDCM 3 CRI: ≥90 DURATA LED: 50.000 h



↑ FOTO p. 278

0,550 Kg  
0,0035 m<sup>3</sup>



LED SMD SAMSUNG (DRIVER ON/OFF INCLUSO)

POTENZA	ANGOLO	LUMEN	CCT	BINARIO	FINITURA	CODICE	€
21 W	125°	2100 lm	2700 K	3-Phase	Bianco	340012	200
21 W	125°	2100 lm	2700 K	3-Phase	Nero	340005	200
21 W	125°	2500 lm	3000 K	3-Phase	Bianco	283753	200
21 W	125°	2500 lm	3000 K	3-Phase	Nero	283760	200
21 W	125°	2800 lm	4000 K	3-Phase	Bianco	276274	200
21 W	125°	2800 lm	4000 K	3-Phase	Nero	283777	200

0,090 Kg  
0,0047 m<sup>3</sup>

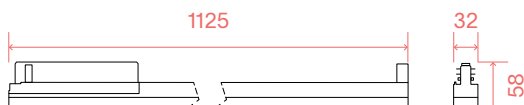

LED SMD SAMSUNG (DRIVER ON/OFF INCLUSO)

POTENZA	ANGOLO	LUMEN	CCT	BINARIO	FINITURA	CODICE	€
40 W	125°	4200 lm	2700 K	3-Phase	Bianco	340036	305
40 W	125°	4200 lm	2700 K	3-Phase	Nero	340029	305
40 W	125°	4600 lm	3000 K	3-Phase	Bianco	283722	305
40 W	125°	4600 lm	3000 K	3-Phase	Nero	283050	305
40 W	125°	5050 lm	4000 K	3-Phase	Bianco	283739	305
40 W	125°	5050 lm	4000 K	3-Phase	Nero	283746	305

# DISPLAY UGR

PROIETTORI



IP20 MacAdam: SDCM 3 UGR: <22 CRI: ≥90 DURATA LED: 50.000 h



↑ FOTO p. 280

0,400 Kg  
0,0064 m<sup>3</sup>



LED SMD SAMSUNG (DRIVER ON/OFF INCLUSO)

POTENZA	ANGOLO	LUMEN	CCT	BINARIO	FINITURA	CODICE	€
14 W	70°	1750 lm	3000 K	3-Phase	Bianco	283685	212
14 W	70°	1750 lm	3000 K	3-Phase	Nero	283692	212
14 W	70°	1800 lm	4000 K	3-Phase	Bianco	283708	212
14 W	70°	1800 lm	4000 K	3-Phase	Nero	283715	212

1,120 Kg  
0,0112 m<sup>3</sup>



LED SMD SAMSUNG (DRIVER ON/OFF INCLUSO)

POTENZA	ANGOLO	LUMEN	CCT	BINARIO	FINITURA	CODICE	€
25 W	70°	3550 lm	3000 K	3-Phase	Bianco	283647	335
25 W	70°	3550 lm	3000 K	3-Phase	Nero	283630	335
25 W	70°	3650 lm	4000 K	3-Phase	Bianco	276281	335
25 W	70°	3650 lm	4000 K	3-Phase	Nero	283258	335

1,570 Kg  
0,0173 m<sup>3</sup>



LED SMD SAMSUNG (DRIVER ON/OFF INCLUSO)

POTENZA	ANGOLO	LUMEN	CCT	BINARIO	FINITURA	CODICE	€
40 W	70°	5350 lm	3000 K	3-Phase	Bianco	283654	470
40 W	70°	5350 lm	3000 K	3-Phase	Nero	283067	470
40 W	70°	5500 lm	4000 K	3-Phase	Bianco	283661	470
40 W	70°	5500 lm	4000 K	3-Phase	Nero	283678	470



# EGO TRACK SINGLE

SISTEMI



IP20 MacAdam: SDCM 3 CRI: ≥90 DURATA LED: 50.000 h



↑ FOTO p. 288

## LED SMD OSRAM

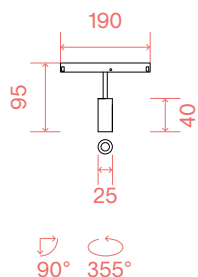

POTENZA	ANGOLO	CONTROLLO	LUMEN	CCT	FINITURA	CODICE	€
3 W	30°	On-Off	200 lm	3000 K	Bianco	282978	80
3 W	30°	On-Off	200 lm	3000 K	Nero	257617	80
3 W	30°	On-Off	220 lm	4000 K	Nero	317977	80
3 W	30°	1-10V	200 lm	3000 K	Bianco	303673	100
3 W	30°	1-10V	200 lm	3000 K	Nero	303666	100
3 W	30°	DALI	200 lm	3000 K	Bianco	286402	125
3 W	30°	DALI	200 lm	3000 K	Nero	286396	125

0,150 Kg  
0,0017 m<sup>3</sup>

## LED COB CITIZEN

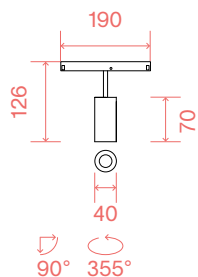

POTENZA	ANGOLO	CONTROLLO	LUMEN	CCT	FINITURA	CODICE	€
8 W	30°	On-Off	720 lm	2700 K	Nero	340388	95
8 W	30°	On-Off	850 lm	3000 K	Bianco	282985	95
8 W	30°	On-Off	850 lm	3000 K	Nero	257631	95
8 W	30°	On-Off	900 lm	4000 K	Nero	317984	95
8 W	30°	1-10V	850 lm	3000 K	Bianco	303697	110
8 W	30°	1-10V	850 lm	3000 K	Nero	303680	110
8 W	30°	DALI	720 lm	2700 K	Nero	340364	135
8 W	30°	DALI	850 lm	3000 K	Bianco	286426	135
8 W	30°	DALI	850 lm	3000 K	Nero	286419	135

0,200 Kg  
0,0017 m<sup>3</sup>

## LED COB CITIZEN

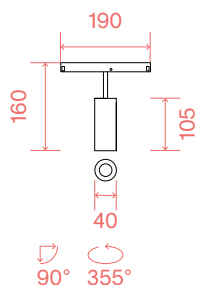

POTENZA	ANGOLO	CONTROLLO	LUMEN	CCT	FINITURA	CODICE	€
12 W	30°	On-Off	1000 lm	2700 K	Nero	340425	95
12 W	30°	On-Off	1200 lm	3000 K	Bianco	282992	95
12 W	30°	On-Off	1200 lm	3000 K	Nero	257655	95
12 W	30°	On-Off	1250 lm	4000 K	Nero	321967	95
12 W	30°	1-10V	1200 lm	3000 K	Bianco	303710	110
12 W	30°	1-10V	1200 lm	3000 K	Nero	303703	110
12 W	30°	DALI	1000 lm	2700 K	Nero	340401	140
12 W	30°	DALI	1200 lm	3000 K	Bianco	286440	140
12 W	30°	DALI	1200 lm	3000 K	Nero	286433	140

0,300 Kg  
0,0017 m<sup>3</sup>

# EGO TRACK SINGLE

SISTEMI



IP20 MacAdam: SDCM 3 CRI: ≥90 DURATA LED: 50.000 h



↑ FOTO p. 288

## LED COB CITIZEN

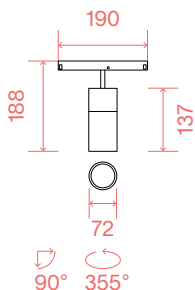

POTENZA	ANGOLO	CONTROLLO	LUMEN	CCT	FINITURA	CODICE	€
19 W	35°	On-Off	2200 lm	3000 K	Bianco	307558	140
19 W	35°	On-Off	2200 lm	3000 K	Nero	305608	140
19 W	35°	On-Off	2350 lm	4000 K	Nero	321998	140
19 W	35°	1-10V	2200 lm	3000 K	Bianco	307527	155
19 W	35°	1-10V	2200 lm	3000 K	Nero	307510	155
19 W	35°	DALI	2200 lm	3000 K	Bianco	307541	185
19 W	35°	DALI	2200 lm	3000 K	Nero	307534	185

0,800 Kg  
0,0035 m<sup>3</sup>

## LED COB CITIZEN

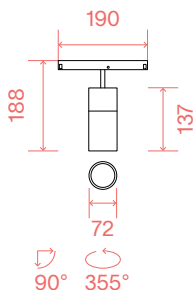

POTENZA	ANGOLO	CONTROLLO	LUMEN	CCT	FINITURA	CODICE	€
26 W	35°	On-Off	3050 lm	3000 K	Bianco	307602	140
26 W	35°	On-Off	3050 lm	3000 K	Nero	305615	140
26 W	35°	On-Off	3150 lm	4000 K	Nero	317991	140
26 W	35°	1-10V	3050 lm	3000 K	Bianco	307572	155
26 W	35°	1-10V	3050 lm	3000 K	Nero	307565	155
26 W	35°	DALI	3050 lm	3000 K	Bianco	307596	185
26 W	35°	DALI	3050 lm	3000 K	Nero	307589	185

0,800 Kg  
0,0035 m<sup>3</sup>

	MODELLO	NECESSARIO	ANGOLO	FINITURA	CODICE	€
LENS	3W	NO	18°	Trasparente	332062	5
LENS	3W	NO	45°	Trasparente	332079	5
LENS	8/12W	NO	18°	Trasparente	332086	5
LENS	8/12W	NO	45°	Trasparente	332083	5
LENS	19/26W	NO	20°	Trasparente	332109	10
LENS	19/26W	NO	55°	Trasparente	332116	10
FILTER HONEYCOMB	3W	NO		Nero	260853	5
FILTER HONEYCOMB	8/12W	NO		Nero	260860	5

# EGO TRACK DOUBLE

SISTEMI



IP20 MacAdam: SDCM 3 CRI: ≥90 DURATA LED: 50.000 h



## LED SMD OSRAM

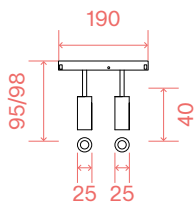

0,220 Kg  
0,0017 m<sup>3</sup>

POTENZA	ANGOLO	CONTROLLO	LUMEN	CCT	FINITURA	CODICE	€
5 W	30°	On-Off	400 lm	3000 K	Bianco	282947	100
5 W	30°	On-Off	400 lm	3000 K	Nero	257624	100
5 W	30°	On-Off	430 lm	4000 K	Nero	321714	100
5 W	30°	1-10V	400 lm	3000 K	Bianco	303611	115
5 W	30°	1-10V	400 lm	3000 K	Nero	303604	115
5 W	30°	DALI	400 lm	3000 K	Bianco	286341	145
5 W	30°	DALI	400 lm	3000 K	Nero	286334	145

## LED COB CITIZEN

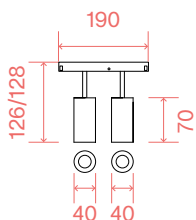

0,450 Kg  
0,0017 m<sup>3</sup>

POTENZA	ANGOLO	CONTROLLO	LUMEN	CCT	FINITURA	CODICE	€
16 W	30°	On-Off	1400 lm	2700 K	Nero	340265	135
16 W	30°	On-Off	1500 lm	3000 K	Bianco	282954	135
16 W	30°	On-Off	1500 lm	3000 K	Nero	257648	135
16 W	30°	On-Off	1550 lm	4000 K	Nero	321806	135
16 W	30°	1-10V	1500 lm	3000 K	Bianco	303635	150
16 W	30°	1-10V	1500 lm	3000 K	Nero	303628	150
16 W	30°	DALI	1400 lm	2700 K	Nero	340241	180
16 W	30°	DALI	1500 lm	3000 K	Bianco	286365	180
16 W	30°	DALI	1500 lm	3000 K	Nero	286358	180

## LED COB CITIZEN

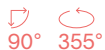
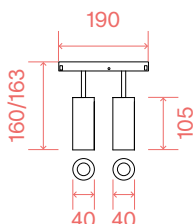

0,330 Kg  
0,0027 m<sup>3</sup>

POTENZA	ANGOLO	CONTROLLO	LUMEN	CCT	FINITURA	CODICE	€
24 W	30°	On-Off	2400 lm	3000 K	Bianco	282961	145
24 W	30°	On-Off	2400 lm	3000 K	Nero	257662	145
24 W	30°	On-Off	2500 lm	4000 K	Nero	321844	145
24 W	30°	1-10V	2400 lm	3000 K	Bianco	303659	155
24 W	30°	1-10V	2400 lm	3000 K	Nero	303642	155
24 W	30°	DALI	2400 lm	3000 K	Bianco	286389	185
24 W	30°	DALI	2400 lm	3000 K	Nero	286372	185

	MODELLO	NECESSARIO	ANGOLO	FINITURA	CODICE	€
LENS	5W	NO	18°	Trasparente	332062	5
LENS	5W	NO	45°	Trasparente	332079	5
LENS	16/24W	NO	18°	Trasparente	332086	5
LENS	16/24W	NO	45°	Trasparente	332093	5
FILTER HONEYCOMB	5W	NO		Nero	260853	5
FILTER HONEYCOMB	16/24W	NO		Nero	260860	5

# EGO TRACK BIG

SISTEMI



IP20 MacAdam: SDCM 3 UGR: <19 CRI: ≥90 DURATA LED: 50.000 h

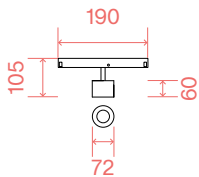

## LED COB CITIZEN

POTENZA	ANGOLO	CONTROLLO	LUMEN	CCT	FINITURA	CODICE	€
10 W	38°	On-Off	1000 lm	3000 K	Bianco	327556	110
10 W	38°	On-Off	1000 lm	3000 K	Nero	300764	110

0,470 Kg  
0,0026 m<sup>3</sup>

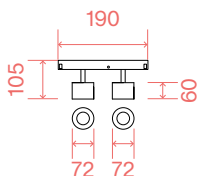

## LED COB CITIZEN

POTENZA	ANGOLO	CONTROLLO	LUMEN	CCT	FINITURA	CODICE	€
20 W	38°	On-Off	2000 lm	3000 K	Bianco	327549	190
20 W	38°	On-Off	2000 lm	3000 K	Nero	316307	190

0,750 Kg  
0,0026 m<sup>3</sup>

# EGO TRACK FLAT

SISTEMI



IP20 MacAdam: SDCM 3 CRI: ≥90 DURATA LED: 50.000 h



↑ FOTO p. 296

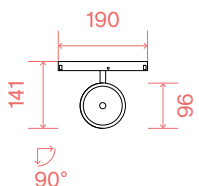

## LED COB CITIZEN

POTENZA	ANGOLO	CONTROLLO	LUMEN	CCT	FINITURA	CODICE	€
9 W	36°	On-Off	1100 lm	3000 K	Bianco	300504	105
9 W	36°	On-Off	1100 lm	3000 K	Nero	290614	105
9 W	36°	1-10V	1100 lm	3000 K	Bianco	303741	120
9 W	36°	1-10V	1100 lm	3000 K	Nero	303727	120
9 W	36°	DALI	1100 lm	3000 K	Bianco	300535	150
9 W	36°	DALI	1100 lm	3000 K	Nero	300528	150

0,480 Kg  
0,0030 m<sup>3</sup>

# EGO TRACK ZOOM

SISTEMI

IP20 MacAdam: SDCM 3 CRI: ≥90 DURATA LED: 50.000 h PRO

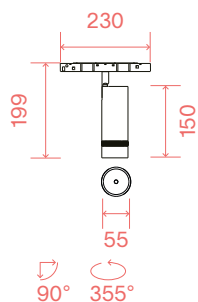

## LED COB CITIZEN

POTENZA	ANGOLO	CONTROLLO	LUMEN	CCT	FINITURA	CODICE	€
10 W	20°-40°	On-Off	1000 lm	3000 K	Nero	330730	120
10 W	20°-40°	On-Off	1100 lm	4000 K	Nero	340197	120
10 W	20°-40°	DALI	1000 lm	3000 K	Nero	330754	175
10 W	20°-40°	DALI	1100 lm	4000 K	Nero	340180	175

0,500 Kg  
0,0035 m<sup>3</sup>

# EGO ACCENT

SISTEMI

IP20 MacAdam: SDCM 3 UGR: <19 CRI: ≥90 DURATA LED: 50.000 h PRO

[↑ FOTO p. 303](#)

0,140 Kg  
0,0013 m<sup>3</sup>

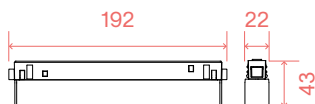

## LED SMD OSRAM

POTENZA	ANGOLO	CONTROLLO	LUMEN	CCT	FINITURA	CODICE	€
7 W	35°	On-Off	630 lm	2700 K	Nero	340067	100
7 W	35°	On-Off	700 lm	3000 K	Bianco	282633	100
7 W	35°	On-Off	700 lm	3000 K	Nero	257792	100
7 W	35°	On-Off	730 lm	4000 K	Nero	323596	100
7 W	35°	1-10V	700 lm	3000 K	Bianco	303505	135
7 W	35°	1-10V	700 lm	3000 K	Nero	303499	135
7 W	35°	DALI	630 lm	2700 K	Nero	340043	145
7 W	35°	DALI	700 lm	3000 K	Bianco	286068	145
7 W	35°	DALI	700 lm	3000 K	Nero	286051	145

# EGO ACCENT

SISTEMI



IP20 MacAdam: SDCM 3 UGR: <19 CRI: ≥90 DURATA LED: 50.000 h



FOTO p. 303

0,330 Kg  
0,0010 m<sup>3</sup>

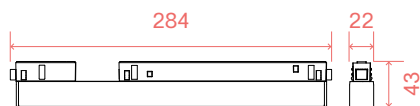

LED SMD OSRAM

POTENZA	ANGOLO	CONTROLLO	LUMEN	CCT	FINITURA	CODICE	€
13 W	35°	On-Off	1250 lm	2700 K	Nero	340104	140
13 W	35°	On-Off	1400 lm	3000 K	Bianco	282640	140
13 W	35°	On-Off	1400 lm	3000 K	Nero	257686	140
13 W	35°	On-Off	1450 lm	4000 K	Nero	317953	140
13 W	35°	1-10V	1400 lm	3000 K	Bianco	303529	170
13 W	35°	1-10V	1400 lm	3000 K	Nero	303512	170
13 W	35°	DALI	1250 lm	2700 K	Nero	340081	200
13 W	35°	DALI	1400 lm	3000 K	Bianco	286082	200
13 W	35°	DALI	1400 lm	3000 K	Nero	286075	200

# EGO WIDE

SISTEMI



IP20 MacAdam: SDCM 3 CRI: ≥90 DURATA LED: 50.000 h



FOTO p. 300

0,200 Kg  
0,0010 m<sup>3</sup>



LED SMD SAMSUNG

POTENZA	ANGOLO	CONTROLLO	LUMEN	CCT	FINITURA	CODICE	€
7 W	110°	On-Off	850 lm	3000 K	Bianco	283029	75
7 W	110°	On-Off	850 lm	3000 K	Nero	257709	75
7 W	110°	On-Off	880 lm	4000 K	Nero	317960	75
7 W	110°	1-10V	850 lm	3000 K	Bianco	303796	120
7 W	110°	1-10V	850 lm	3000 K	Nero	303789	120
7 W	110°	DALI	850 lm	3000 K	Bianco	286501	120
7 W	110°	DALI	850 lm	3000 K	Nero	286495	120

# EGO WIDE

SISTEMI



IP20 MacAdam: SDCM 3 CRI: ≥90 DURATA LED: 50.000 h



↑ FOTO p. 300

0,500 Kg  
0,0016 m<sup>3</sup>

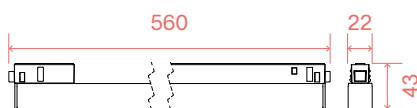

## LED SMD SAMSUNG

POTENZA	ANGOLO	CONTROLLO	LUMEN	CCT	FINITURA	CODICE	€
13 W	110°	On-Off	1450 lm	2700 K	Nero	340586	100
13 W	110°	On-Off	1700 lm	3000 K	Bianco	283036	100
13 W	110°	On-Off	1700 lm	3000 K	Nero	257716	100
13 W	110°	On-Off	1750 lm	4000 K	Nero	322056	100
13 W	110°	1-10V	1700 lm	3000 K	Bianco	303819	130
13 W	110°	1-10V	1700 lm	3000 K	Nero	303802	130
13 W	110°	DALI	1450 lm	2700 K	Nero	340562	145
13 W	110°	DALI	1700 lm	3000 K	Bianco	286525	145
13 W	110°	DALI	1700 lm	3000 K	Nero	286518	145

0,920 Kg  
0,0031 m<sup>3</sup>



## LED SMD SAMSUNG

POTENZA	ANGOLO	CONTROLLO	LUMEN	CCT	FINITURA	CODICE	€
26 W	110°	On-Off	2900 lm	2700 K	Nero	340623	145
26 W	110°	On-Off	3400 lm	3000 K	Bianco	283043	145
26 W	110°	On-Off	3400 lm	3000 K	Nero	257730	145
26 W	110°	On-Off	3500 lm	4000 K	Nero	322070	145
26 W	110°	1-10V	3400 lm	3000 K	Bianco	303833	160
26 W	110°	1-10V	3400 lm	3000 K	Nero	303826	160
26 W	110°	DALI	2900 lm	2700 K	Nero	340609	185
26 W	110°	DALI	3400 lm	3000 K	Bianco	286549	185
26 W	110°	DALI	3400 lm	3000 K	Nero	286532	185

# EGO FLEXIBLE ACCENT

SISTEMI

↑ IP20 MacAdam: SDCM 3 CRI: ≥90 UGR <19 DURATA LED: 50.000 h (PRO)

0,470 Kg  
0,0031 m<sup>3</sup>

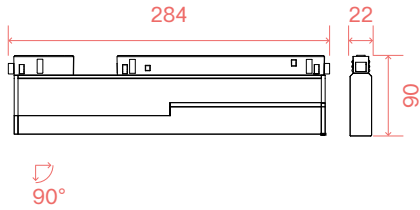

LED SMD SAMSUNG

POTENZA	ANGOLO	CONTROLLO	LUMEN	CCT	FINITURA	CODICE	€
13 W	35°	On-Off	1400 lm	3000 K	Bianco	282718	175
13 W	35°	On-Off	1400 lm	3000 K	Nero	257846	175
13 W	35°	DALI	1400 lm	3000 K	Bianco	286105	215
13 W	35°	DALI	1400 lm	3000 K	Nero	286099	215

# EGO FLEXIBLE WIDE

SISTEMI

⬮ IP20 MacAdam: SDCM 3 CRI: ≥90 DURATA LED: 50.000 h (PRO)

0,620 Kg  
0,0016 m<sup>3</sup>

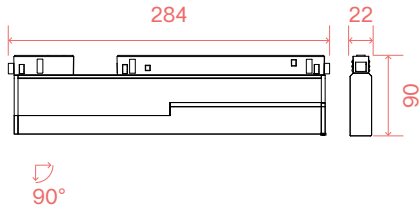

LED SMD SAMSUNG

POTENZA	ANGOLO	CONTROLLO	LUMEN	CCT	FINITURA	CODICE	€
7 W	110°	On-Off	850 lm	3000 K	Bianco	282725	120
7 W	110°	On-Off	850 lm	3000 K	Nero	257839	120
7 W	110°	DALI	850 lm	3000 K	Bianco	286129	160
7 W	110°	DALI	850 lm	3000 K	Nero	286112	160



# EGO PENDANT

SISTEMI



MacAdam: SDCM 3 UGR: <19 CRI: ≥90 DURATA LED: 50.000 h

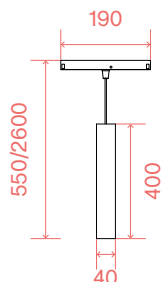

0,550 Kg  
0,0023 m<sup>3</sup>

## LED COB CITIZEN (UGR <19)

POTENZA	ANGOLO	CONTROLLO	LUMEN	CCT	FINITURA	CODICE	€
12 W	30°	On-Off	1050 lm	3000 K	Bianco	282879	145
12 W	30°	On-Off	1050 lm	3000 K	Nero	257747	145
12 W	30°	On-Off	1150 lm	4000 K	Nero	321653	145
12 W	30°	1-10V	1050 lm	3000 K	Bianco	303598	155
12 W	30°	1-10V	1050 lm	3000 K	Nero	303574	155
12 W	30°	DALI	1050 lm	3000 K	Bianco	286327	185
12 W	30°	DALI	1050 lm	3000 K	Nero	286310	185

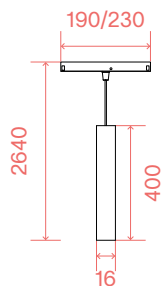

0,150 Kg  
0,0020 m<sup>3</sup>

## LED COB

POTENZA	ANGOLO	CONTROLLO	LUMEN	CCT	FINITURA	CODICE	€
5,5 W	66°	On-Off	530 lm	3000 K	Nero	332451	90
5,5 W	66°	1-10V	530 lm	3000 K	Nero	344782	110
5,5 W	66°	DALI	530 lm	3000 K	Nero	344799	140

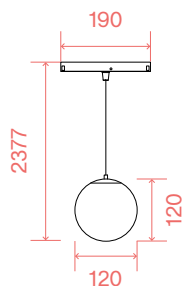

0,900 Kg  
0,0125 m<sup>3</sup>

## LED COB CITIZEN

POTENZA	CONTROLLO	LUMEN	CCT	FINITURA	CODICE	€
10 W	On-Off	1050 lm	3000 K	Bianco	327532	130
10 W	On-Off	1050 lm	3000 K	Nero	327525	130

# EGO - LOW

## SISTEMI

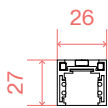

TRACK LOW (KIT DI MONTAGGIO NON NECESSARIO, FISSAGGIO DIRETTO A SOFFITTO  
LUNGHEZZA MASSIMA PER PUNTO DI ALIMENTAZIONE: 25 METRI)

LUNGHEZZA	PESO	VOLUME	FINITURA	CODICE	€
1000 mm	0,68 Kg	0,0013 m <sup>3</sup>	Bianco	282909	45
1000 mm	0,68 Kg	0,0013 m <sup>3</sup>	Nero	257877	45
2000 mm	1,36 Kg	0,0026 m <sup>3</sup>	Bianco	282916	95
2000 mm	1,36 Kg	0,0026 m <sup>3</sup>	Nero	266121	95

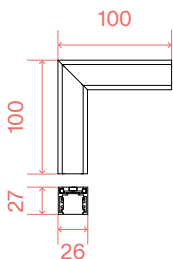

CONNECTOR HORIZONTAL LOW (OPTIONAL)

PESO	VOLUME	CONTROLLO	FINITURA	CODICE	€
0,21 Kg	0,0009 m <sup>3</sup>	On-Off	Bianco	282848	95
0,21 Kg	0,0009 m <sup>3</sup>	On-Off	Nero	257990	95
0,21 Kg	0,0009 m <sup>3</sup>	1-10V / DALI	Bianco	286266	100
0,21 Kg	0,0009 m <sup>3</sup>	1-10V / DALI	Nero	286259	100

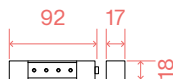

LINEAR CONNECTOR (NECESSARIO - 1 KIT X GIUNZIONE LINEARE)

PESO	VOLUME	CONTROLLO	FINITURA	CODICE	€
0,16 Kg	0,0005 m <sup>3</sup>	On-Off	Bianco	285993	40
0,16 Kg	0,0005 m <sup>3</sup>	On-Off	Nero	283104	40
0,16 Kg	0,0005 m <sup>3</sup>	1-10V / DALI	Bianco	285993	40
0,16 Kg	0,0005 m <sup>3</sup>	1-10V / DALI	Nero	283104	40

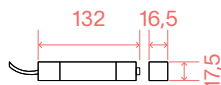

MAIN CONNECTOR (NECESSARIO - 1 KIT X PUNTO DI ALIMENTAZ. MAX 210W)

PESO	VOLUME	CONTROLLO	FINITURA	CODICE	€
0,12 Kg	0,0007 m <sup>3</sup>	On-Off	Bianco	282862	36
0,12 Kg	0,0007 m <sup>3</sup>	On-Off	Nero	265896	36
0,12 Kg	0,0007 m <sup>3</sup>	1-10V / DALI	Bianco	286303	50
0,12 Kg	0,0007 m <sup>3</sup>	1-10V / DALI	Nero	286297	50

Lunghezza cavo 2000 mm

	NECESSARIO	MISURA (L X H X P)	FINITURA	CODICE	€
END CAP NO HOLE	SI	26 x 11 x 27 mm	Bianco	282688	6
END CAP NO HOLE	SI	26 x 11 x 27 mm	Nero	267241	6
END CAP WITH HOLE	SI	26 x 11 x 27 mm	Bianco	282671	6
END CAP WITH HOLE	SI	26 x 11 x 27 mm	Nero	267258	6
SUSPENSION KIT	SI - 1 Kit x punto di alimentaz. max 210W	2000 mm	Bianco	282749	55
SUSPENSION KIT		2000 mm	Nero	276328	55
KIT SINGLE CABLE	SI - 1 Kit x 900 mm	2000 mm	Bianco	282756	17
KIT SINGLE CABLE		2000 mm	Nero	259376	17
BLINDED COVER	NO	1000 x 17 x 18 mm	Bianco	344751	10
BLINDED COVER	NO	1000 x 17 x 18 mm	Nero	344768	10

# EGO - LOW - ASSEMBLY PLANS

## SISTEMI

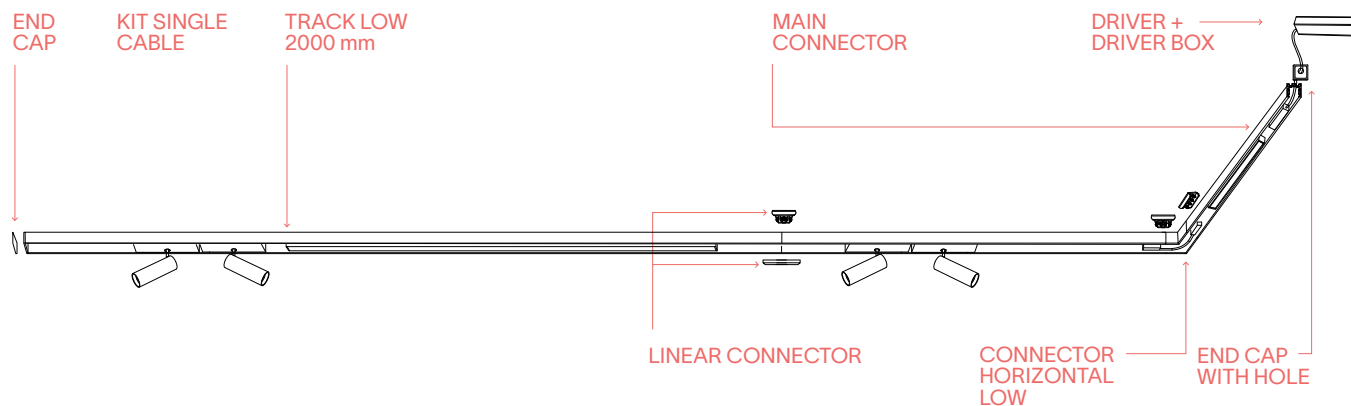
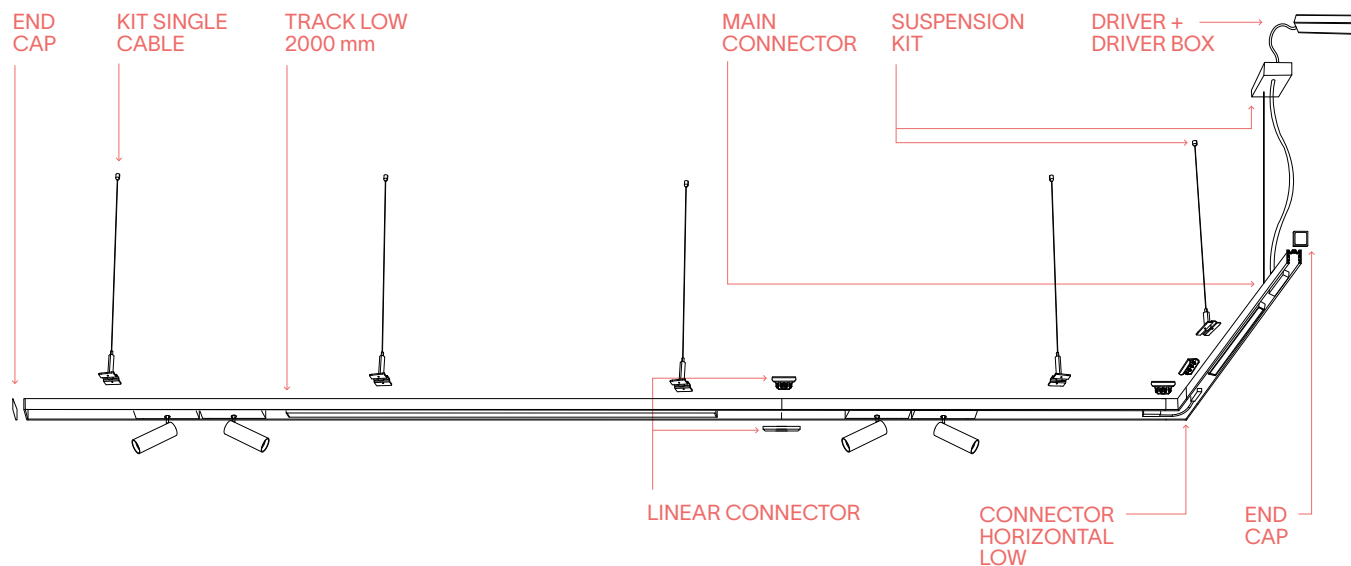

# EGO - HIGH

## SISTEMI

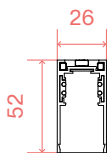

TRACK HIGH (KIT DI MONTAGGIO NON NECESSARIO, FISSAGGIO DIRETTO A SOFFITTO  
LUNGHEZZA MASSIMA PER PUNTO DI ALIMENTAZIONE: 25 METRI)

LUNGHEZZA	PESO	VOLUME	FINITURA	CODICE	€
1000 mm	0,90 Kg	0,0023 m <sup>3</sup>	Bianco	282886	50
1000 mm	0,90 Kg	0,0023 m <sup>3</sup>	Nero	258027	50
2000 mm	1,80 Kg	0,0046 m <sup>3</sup>	Bianco	282893	120
2000 mm	1,80 Kg	0,0046 m <sup>3</sup>	Nero	266145	120

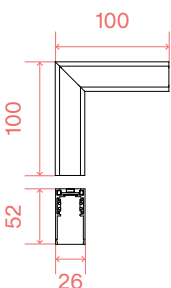

CONNECTOR HORIZONTAL HIGH (OPTIONAL)

PESO	VOLUME	CONTROLLO	FINITURA	CODICE	€
0,26 Kg	0,0013 m <sup>3</sup>	On-Off	Bianco	282824	90
0,26 Kg	0,0013 m <sup>3</sup>	On-Off	Nero	258140	90
0,26 Kg	0,0013 m <sup>3</sup>	1-10V / DALI	Bianco	286228	100
0,26 Kg	0,0013 m <sup>3</sup>	1-10V / DALI	Nero	286211	100

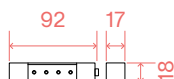

LINEAR CONNECTOR (NECESSARIO - 1 KIT X GIUNZIONE LINEARE)

PESO	VOLUME	CONTROLLO	FINITURA	CODICE	€
0,16 Kg	0,0005 m <sup>3</sup>	On-Off	Bianco	285993	40
0,16 Kg	0,0005 m <sup>3</sup>	On-Off	Nero	283104	40
0,16 Kg	0,0005 m <sup>3</sup>	1-10V / DALI	Bianco	285993	40
0,16 Kg	0,0005 m <sup>3</sup>	1-10V / DALI	Nero	283104	40

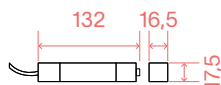

MAIN CONNECTOR (NECESSARIO - 1 KIT X PUNTO DI ALIMENTAZ. MAX 210W)

PESO	VOLUME	CONTROLLO	FINITURA	CODICE	€
0,12 Kg	0,0007 m <sup>3</sup>	On-Off	Bianco	282862	36
0,12 Kg	0,0007 m <sup>3</sup>	On-Off	Nero	265896	36
0,12 Kg	0,0007 m <sup>3</sup>	1-10V / DALI	Bianco	286303	50
0,12 Kg	0,0007 m <sup>3</sup>	1-10V / DALI	Nero	286297	50

Lunghezza cavo 2000 mm

	NECESSARIO	MISURA (L X H X P)	FINITURA	CODICE	€
END CAP NO HOLE	SI	26 x 11 x 52 mm	Bianco	282664	6
END CAP NO HOLE	SI	26 x 11 x 52 mm	Nero	267227	6
END CAP WITH HOLE	SI	26 x 11 x 52 mm	Bianco	282657	6
END CAP WITH HOLE	SI	26 x 11 x 52 mm	Nero	267234	6
SUSPENSION KIT	SI - 1 Kit x punto di alimentaz. max 210W	2000 mm	Bianco	282749	55
SUSPENSION KIT		2000 mm	Nero	276328	55
KIT SINGLE CABLE	SI - 1 Kit x 900 mm	2000 mm	Bianco	282756	17
KIT SINGLE CABLE		2000 mm	Nero	259376	17
BLINDED COVER	NO	1000 x 5 x 24 mm	Bianco	282770	17
BLINDED COVER	NO	1000 x 5 x 24 mm	Nero	258256	17

# EGO - HIGH - ASSEMBLY PLANS

## SISTEMI

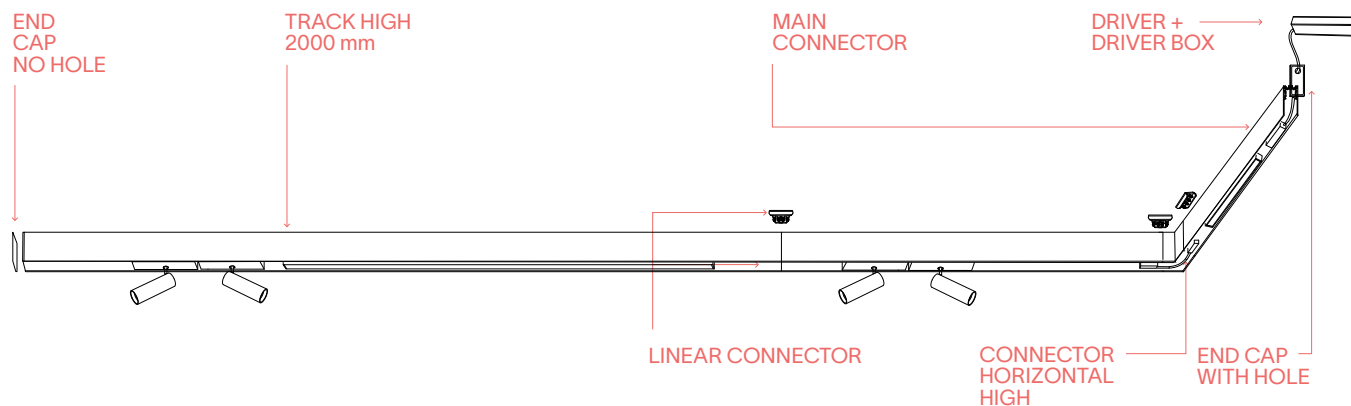
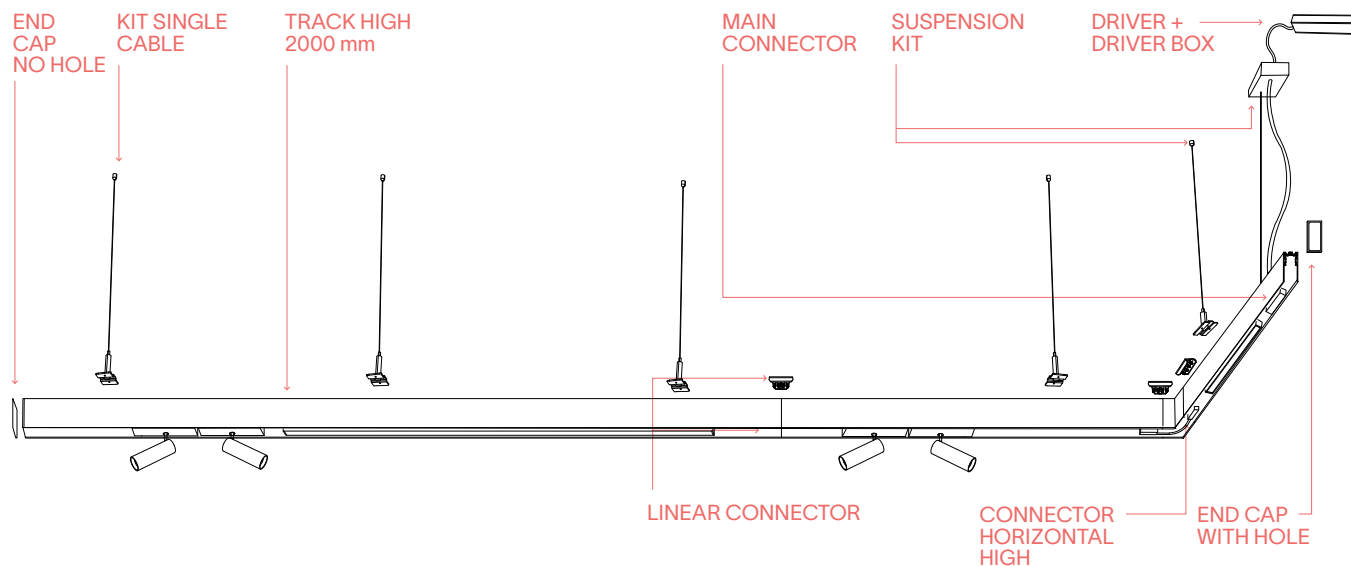

# EGO - RECESSED

## SISTEMI

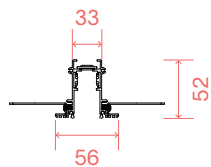

TRACK (KIT PER MONTAGGIO PROFILO INCLUSO  
LUNGHEZZA MASSIMA PER PUNTO DI ALIMENTAZIONE: 25 METRI)

LUNGHEZZA	PESO	VOLUME	FINITURA	CODICE	€
1000 mm	1,52 Kg	0,0039 m <sup>3</sup>	Bianco	282923	70
1000 mm	1,52 Kg	0,0039 m <sup>3</sup>	Nero	258171	70
2000 mm	2,94 Kg	0,0078 m <sup>3</sup>	Bianco	282930	150
2000 mm	2,94 Kg	0,0078 m <sup>3</sup>	Nero	266183	150

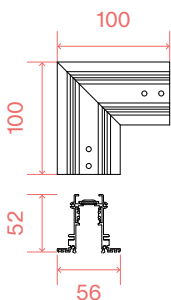

CONNECTOR HORIZONTAL (OPTIONAL)

PESO	VOLUME	CONTROLLO	FINITURA	CODICE	€
0,32 Kg	0,0013 m <sup>3</sup>	On-Off	Bianco	282787	90
0,32 Kg	0,0013 m <sup>3</sup>	On-Off	Nero	258232	90
0,32 Kg	0,0013 m <sup>3</sup>	1-10V / DALI	Bianco	286204	125
0,32 Kg	0,0013 m <sup>3</sup>	1-10V / DALI	Nero	286167	125

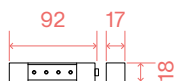

LINEAR CONNECTOR (NECESSARIO - 1 KIT X GIUNZIONE LINEARE)

PESO	VOLUME	CONTROLLO	FINITURA	CODICE	€
0,16 Kg	0,0005 m <sup>3</sup>	On-Off	Bianco	283111	40
0,16 Kg	0,0005 m <sup>3</sup>	On-Off	Nero	286006	40
0,16 Kg	0,0005 m <sup>3</sup>	1-10V / DALI	Bianco	283111	40
0,16 Kg	0,0005 m <sup>3</sup>	1-10V / DALI	Nero	286006	40

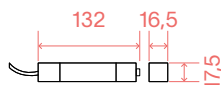

MAIN CONNECTOR (NECESSARIO - 1 KIT X PUNTO DI ALIMENTAZ. MAX 210W)

PESO	VOLUME	CONTROLLO	FINITURA	CODICE	€
0,12 Kg	0,0007 m <sup>3</sup>	On-Off	Bianco	282862	36
0,12 Kg	0,0007 m <sup>3</sup>	On-Off	Nero	265896	36
0,12 Kg	0,0007 m <sup>3</sup>	1-10V / DALI	Bianco	286303	50
0,12 Kg	0,0007 m <sup>3</sup>	1-10V / DALI	Nero	286297	50

Lunghezza cavo 2000 mm

	NECESSARIO	MISURA (L X H X P)	FINITURA	CODICE	€
END CAP NO HOLE	SI	36 x 4 x 52 mm	Bianco	282701	5
END CAP NO HOLE	SI	36 x 4 x 52 mm	Nero	267203	5
END CAP WITH HOLE	SI	36 x 4 x 52 mm	Bianco	282695	6
END CAP WITH HOLE	SI	36 x 4 x 52 mm	Nero	267210	6
BLINDED COVER	NO	1000 x 5 x 24 mm	Bianco	282770	17
BLINDED COVER	NO	1000 x 5 x 24 mm	Nero	258256	17
INSTALLATION TOOL	NO		Nero	292922	31

# EGO - RECESSED - ASSEMBLY PLANS

## SISTEMI

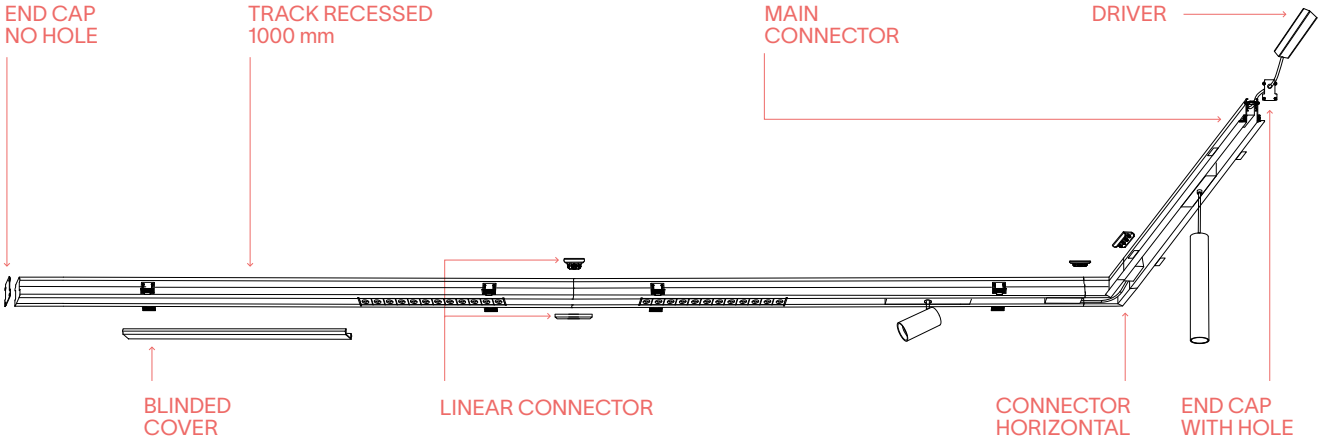

# EGO - RECESSED EASY

## SISTEMI

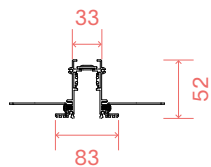

TRACK (KIT DI MONTAGGIO NON NECESSARIO, FISSAGGIO DIRETTO A SOFFITTO  
LUNGHEZZA MASSIMA PER PUNTO DI ALIMENTAZIONE: 25 METRI)

LUNGHEZZA	PESO	VOLUME	FINITURA	CODICE	€
1000 mm	1,16 Kg	0,0058 m <sup>3</sup>	Bianco	320489	65
1000 mm	1,16 Kg	0,0058 m <sup>3</sup>	Nero	320472	65
2000 mm	2,40 Kg	0,0122 m <sup>3</sup>	Bianco	320502	130
2000 mm	2,40 Kg	0,0122 m <sup>3</sup>	Nero	320496	130

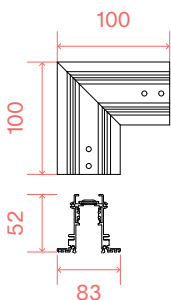

CONNECTOR HORIZONTAL (OPTIONAL)

PESO	VOLUME	CONTROLLO	FINITURA	CODICE	€
0,30 Kg	0,0010 m <sup>3</sup>	On-Off	Bianco	320748	115
0,30 Kg	0,0010 m <sup>3</sup>	On-Off	Nero	320731	115
0,30 Kg	0,0010 m <sup>3</sup>	1-10V / DALI	Bianco	320724	135
0,30 Kg	0,0010 m <sup>3</sup>	1-10V / DALI	Nero	320717	135

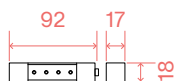

LINEAR CONNECTOR (NECESSARIO - 1 KIT X GIUNZIONE LINEARE)

PESO	VOLUME	CONTROLLO	FINITURA	CODICE	€
0,16 Kg	0,0005 m <sup>3</sup>	On-Off	Bianco	283111	40
0,16 Kg	0,0005 m <sup>3</sup>	On-Off	Nero	286006	40
0,16 Kg	0,0005 m <sup>3</sup>	1-10V / DALI	Bianco	283111	40
0,16 Kg	0,0005 m <sup>3</sup>	1-10V / DALI	Nero	286006	40

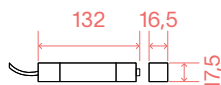

MAIN CONNECTOR (NECESSARIO - 1 KIT X PUNTO DI ALIMENTAZ. MAX 210W)

PESO	VOLUME	CONTROLLO	FINITURA	CODICE	€
0,12 Kg	0,0007 m <sup>3</sup>	On-Off	Bianco	282862	36
0,12 Kg	0,0007 m <sup>3</sup>	On-Off	Nero	265896	36
0,12 Kg	0,0007 m <sup>3</sup>	1-10V / DALI	Bianco	286303	50
0,12 Kg	0,0007 m <sup>3</sup>	1-10V / DALI	Nero	286297	50

Lunghezza cavo 2000 mm

	NECESSARIO	MISURA (L X H X P)	FINITURA	CODICE	€
END CAP NO HOLE	SI	83 x 52 x 30 mm	Bianco	320564	6
END CAP NO HOLE	SI	83 x 52 x 30 mm	Nero	320557	6
END CAP WITH HOLE	SI	83 x 52 x 30 mm	Bianco	320588	6
END CAP WITH HOLE	SI	83 x 52 x 30 mm	Nero	320571	6
BLINDED COVER	NO	1000 x 5 x 24 mm	Bianco	282770	17
BLINDED COVER	NO	1000 x 5 x 24 mm	Nero	258256	17



# EGO - RECESSED EASY - ASSEMBLY PLANS

## SISTEMI

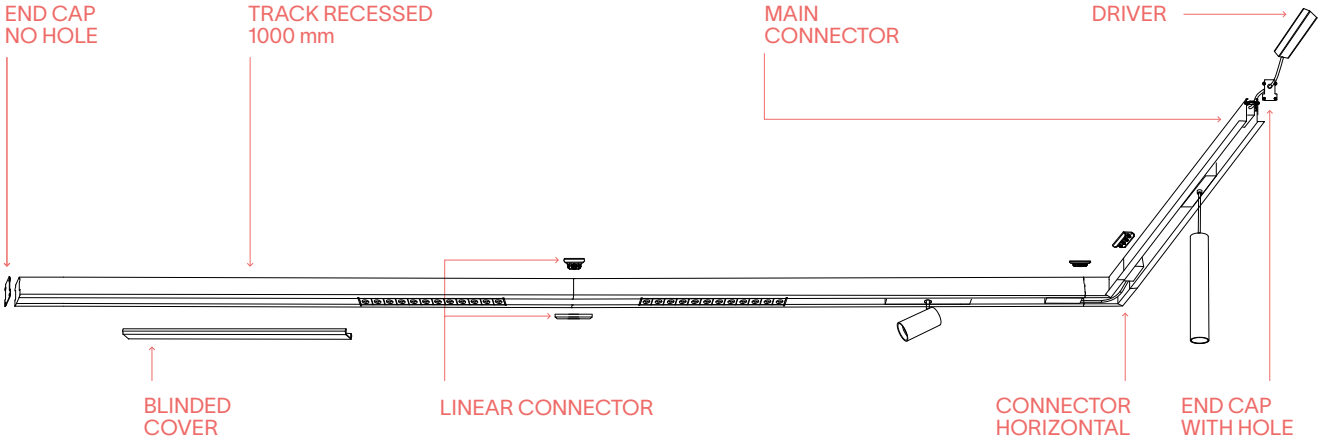

# EGO - BI-EMISSION

## SISTEMI

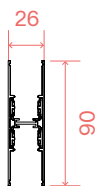

### TRACK BI-EMISSION (LUNGHEZZA MASSIMA PER PUNTO DI ALIMENTAZIONE: 13 METRI)

LUNGHEZZA	PESO	VOLUME	FINITURA	CODICE	€
1000 mm	1,40kg	0,0058 m <sup>3</sup>	Nero	322513	145
2000 mm	2,90 Kg	0,0080 m <sup>3</sup>	Nero	340647	290

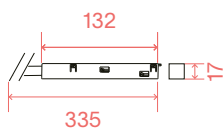

### BI-EMISSION LINEAR CONNECTOR (NECESSARIO - 1 KIT X GIUNZIONE LINEARE)

PESO	VOLUME	CONTROLLO	FINITURA	CODICE	€
0,271 Kg	0,0032 m <sup>3</sup>	On-Off	Nero	339863	215
0,271 Kg	0,0032 m <sup>3</sup>	1-10V / DALI	Nero	351346	240

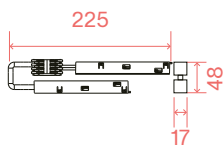

### BI-EMISSION UP/DOWN ELECTRICAL CONNECTOR (NECESSARIO - 1 KIT X GIUNZIONE LINEARE)

PESO	VOLUME	CONTROLLO	FINITURA	CODICE	€
0,100 Kg	0,0016 m <sup>3</sup>	On-Off	Nero	322810	70
0,100 Kg	0,0016 m <sup>3</sup>	1-10V / DALI	Nero	342757	80

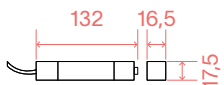

Lunghezza cavo 2000 mm

### MAIN CONNECTOR (NECESSARIO - 1 KIT X PUNTO DI ALIMENTAZ. MAX 210 W)

PESO	VOLUME	CONTROLLO	FINITURA	CODICE	€
0,12 Kg	0,0005 m <sup>3</sup>	On-Off	Bianco	282862	36
0,12 Kg	0,0005 m <sup>3</sup>	On-Off	Nero	265896	36
0,12 Kg	0,0005 m <sup>3</sup>	1-10V / DALI	Bianco	286303	50
0,12 Kg	0,0005 m <sup>3</sup>	1-10V / DALI	Nero	286297	50

	NECESSARIO	MISURA (L X H X P)	FINITURA	CODICE	€
END CAP NO HOLE	SI	26 x 90 x 2 mm	Bianco	322841	6
END CAP WITH HOLE	SI	26 x 90 x 2 mm	Nero	322858	6
SUSPENSION KIT	SI - 1 Kit x punto di alimentaz. max 210W	2100 mm	Bianco	322476	55
KIT SINGLE CABLE	SI - 1 Kit x 900 mm	2085 mm	Bianco	322490	35
BLINDED COVER	NO	1000 x 5 x 24 mm	Nero	258256	17

# EGO - BI-EMISSION - ASSEMBLY PLANS

## SISTEMI

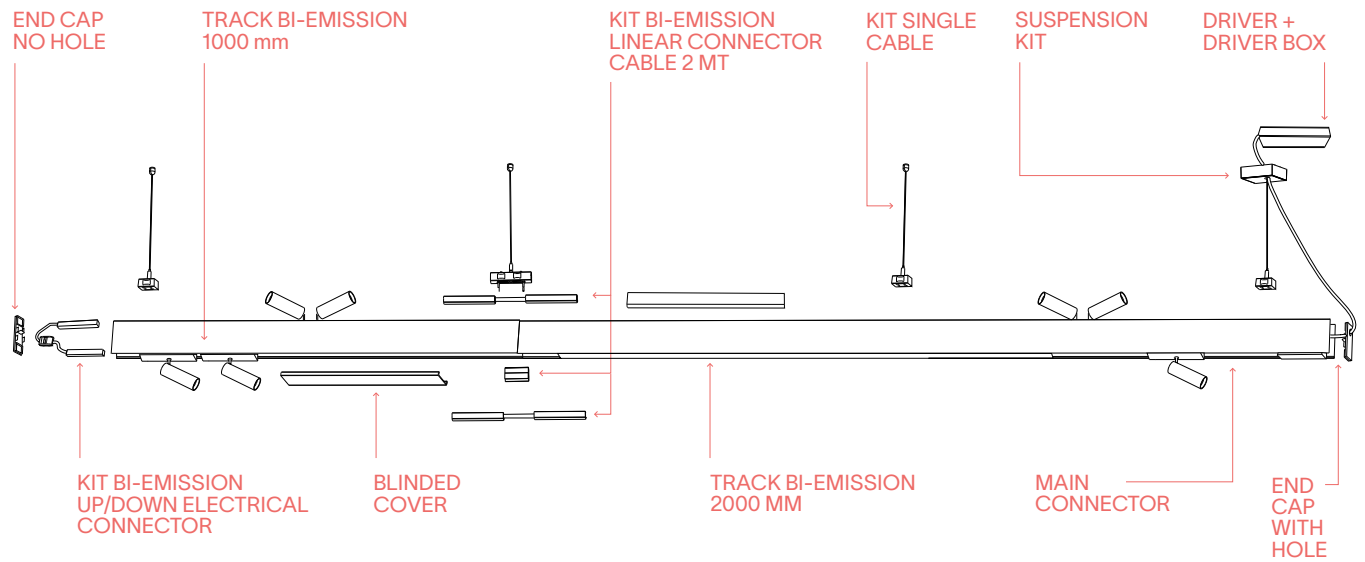

# EGO - RECESSED TRIM

## SISTEMI

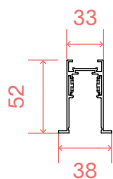

TRACK (KIT PER MONTAGGIO PROFILO INCLUSO  
LUNGHEZZA MASSIMA PER PUNTO DI ALIMENTAZIONE: 25 METRI)

LUNGHEZZA	PESO	VOLUME	FINITURA	CODICE	€
1000 mm	1,13 Kg	0,0058 m <sup>3</sup>	Bianco	320441	85
1000 mm	1,13 Kg	0,0058 m <sup>3</sup>	Nero	320434	85
2000 mm	2,25 Kg	0,0122 m <sup>3</sup>	Bianco	320465	170
2000 mm	2,25 Kg	0,0122 m <sup>3</sup>	Nero	320458	170

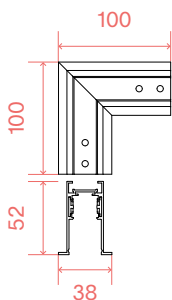

CONNECTOR HORIZONTAL (OPTIONAL)

PESO	VOLUME	CONTROLLO	FINITURA	CODICE	€
0,30 Kg	0,0010 m <sup>3</sup>	On-Off	Bianco	320625	125
0,30 Kg	0,0010 m <sup>3</sup>	On-Off	Nero	320618	125
0,30 Kg	0,0010 m <sup>3</sup>	1-10V / DALI	Bianco	320601	145
0,30 Kg	0,0010 m <sup>3</sup>	1-10V / DALI	Nero	320595	145

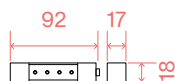

LINEAR CONNECTOR (NECESSARIO - 1 KIT X GIUNZIONE LINEARE)

PESO	VOLUME	CONTROLLO	FINITURA	CODICE	€
0,16 Kg	0,0005 m <sup>3</sup>	On-Off	Bianco	283111	40
0,16 Kg	0,0005 m <sup>3</sup>	On-Off	Nero	286006	40
0,16 Kg	0,0005 m <sup>3</sup>	1-10V / DALI	Bianco	283111	40
0,16 Kg	0,0005 m <sup>3</sup>	1-10V / DALI	Nero	286006	40

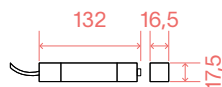

MAIN CONNECTOR (NECESSARIO - 1 KIT X PUNTO DI ALIMENTAZ. MAX 210W)

PESO	VOLUME	CONTROLLO	FINITURA	CODICE	€
0,12 Kg	0,0007 m <sup>3</sup>	On-Off	Bianco	282862	36
0,12 Kg	0,0007 m <sup>3</sup>	On-Off	Nero	265896	36
0,12 Kg	0,0007 m <sup>3</sup>	1-10V / DALI	Bianco	286303	50
0,12 Kg	0,0007 m <sup>3</sup>	1-10V / DALI	Nero	286297	50

Lunghezza cavo 2000 mm

	NECESSARIO	MISURA (L X H X P)	FINITURA	CODICE	€
END CAP NO HOLE	SI	38 x 52 x 17 mm	Bianco	320526	6
END CAP NO HOLE	SI	38 x 52 x 17 mm	Nero	320519	6
END CAP WITH HOLE	SI	38 x 52 x 17 mm	Bianco	320540	9
END CAP WITH HOLE	SI	38 x 52 x 17 mm	Nero	320533	9
BLINDED COVER	NO	1000 x 5 x 24 mm	Bianco	282770	17
BLINDED COVER	NO	1000 x 5 x 24 mm	Nero	258256	17

# EGO - RECESSED TRIM - ASSEMBLY PLANS

## SISTEMI

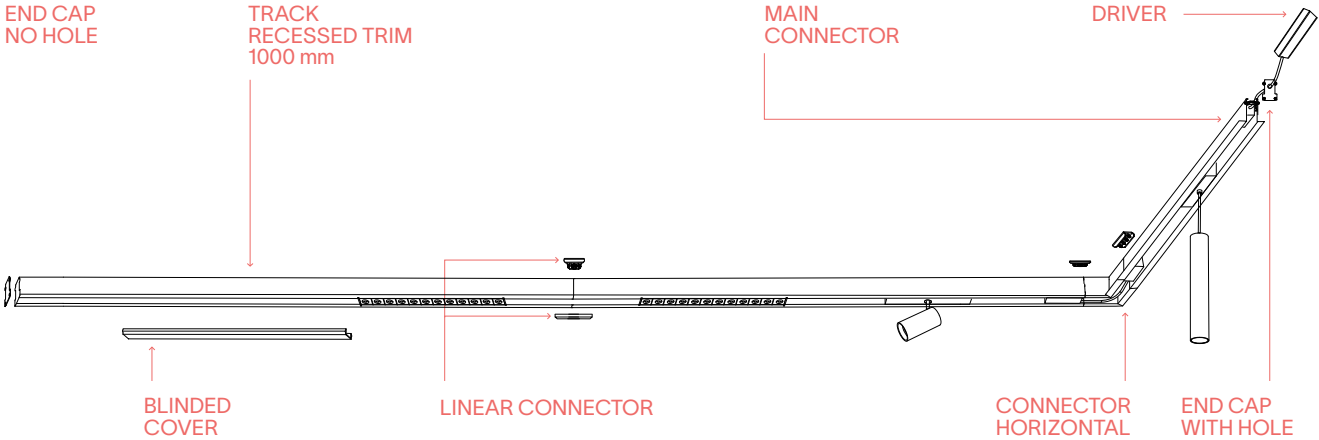

# EGO - DRIVERS

## SISTEMI

### DRIVER MEANWELL ON/OFF (NECESSARIO)

POTENZA	OUTPUT	MISURA (L X H X P)	DRIVER BOX	CODICE	€
75 W	48 Vdc	171x37x62 mm	255x55x75 mm	223155	140
96 W	48 Vdc	220x37x68 mm	330x60x80 mm	223162	185
150 W	48 Vdc	228x37x68 mm	330x60x80 mm	223179	205
240 W	48 Vdc	244x39x68 mm	330x60x80 mm	224275	230

### DRIVER BOX (OPTIONAL)

MATERIALE	MISURE	FINITURA	CODICE	€
Metal	255x55x75 mm	Bianco	302379	25
Metal	255x55x75 mm	Nero	302362	25
Metal	330x60x80 mm	Bianco	302355	30
Metal	330x60x80 mm	Nero	302348	30

### MAGNETIC DRIVER (NECESSARIO - LUNGHEZZA CAVO 2000 mm SOSTITUISCE DRIVER + MAIN CONNECTOR\*)

POTENZA	OUTPUT	MISURA (L X H X P)	CODICE	€
100 W	48 Vdc	297x20x16 mm	296302	90
150 W	48 Vdc	268x43x16 mm	325750	95
250 W	48 Vdc	268x43x16 mm	325767	110

\*Codici 325750 e 325767 consigliati per l'impiego nelle versioni HIGH e RECESSED.

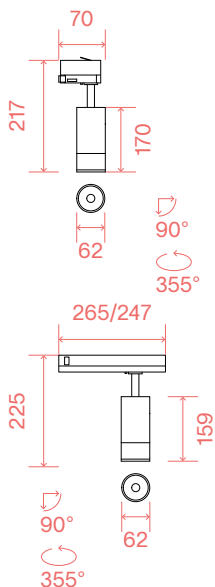

0,710 Kg  
0,0026 m<sup>3</sup>

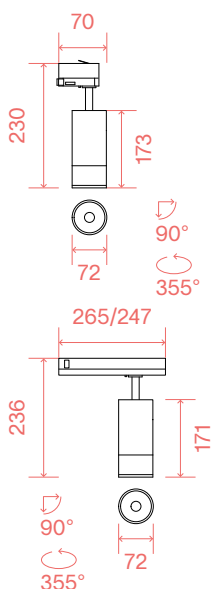

1,100 Kg  
0,0033 m<sup>3</sup>

**LED COB BRIDGELUX (DRIVER INCLUSO)**

POTENZA	ANGOLO	CONTROLLO	LUMEN	CCT	BINARIO	FINITURA	CODICE	€
15 W	20-55°	On-Off	1400 lm	2700 K	3-Phase	Bianco	340807	73
15 W	20-55°	On-Off	1400 lm	2700 K	3-Phase	Nero	340791	73
15 W	20-55°	On-Off	1450 lm	3000 K	3-Phase	Bianco	286594	73
15 W	20-55°	On-Off	1450 lm	3000 K	3-Phase	Nero	276182	73
15 W	20-55°	On-Off	1650 lm	4000 K	3-Phase	Bianco	322094	73
15 W	20-55°	On-Off	1650 lm	4000 K	3-Phase	Nero	322087	73
15 W	20-55°	1-10V	1450 lm	3000 K	3-Phase	Bianco	302959	116
15 W	20-55°	1-10V	1450 lm	3000 K	3-Phase	Nero	302942	116
15 W	20-55°	DALI	1450 lm	3000 K	3-Phase	Bianco	302997	135
15 W	20-55°	DALI	1450 lm	3000 K	3-Phase	Nero	302980	135
15 W	20-55°	On-Off	1450 lm	3000 K	1-Phase	Nero	337579	65

**LED COB BRIDGELUX (DRIVER INCLUSO)**

POTENZA	ANGOLO	CONTROLLO	LUMEN	CCT	BINARIO	FINITURA	CODICE	€
25 W	20-55°	On-Off	2450 lm	2700 K	3-Phase	Bianco	340821	92
25 W	20-55°	On-Off	2450 lm	2700 K	3-Phase	Nero	340814	92
25 W	20-55°	On-Off	2500 lm	3000 K	3-Phase	Bianco	286600	92
25 W	20-55°	On-Off	2500 lm	3000 K	3-Phase	Nero	276243	92
25 W	20-55°	On-Off	2650 lm	4000 K	3-Phase	Bianco	322124	92
25 W	20-55°	On-Off	2650 lm	4000 K	3-Phase	Nero	322100	92
25 W	20-55°	1-10V	2500 lm	3000 K	3-Phase	Bianco	302973	135
25 W	20-55°	1-10V	2500 lm	3000 K	3-Phase	Nero	302966	135
25 W	20-55°	DALI	2500 lm	3000 K	3-Phase	Bianco	303017	155
25 W	20-55°	DALI	2500 lm	3000 K	3-Phase	Nero	303000	155
25 W	20-55°	On-Off	2500 lm	3000 K	1-Phase	Nero	342740	85

	NECESSARIO	DRIVER	FINITURA	CODICE	€
LINK SINGLE CONNECTION	NO	On/Off	Bianco	170145	27
LINK SINGLE CONNECTION	NO	On/Off	Nero	170152	27

# FLUO WIDE

SISTEMI



IP20

MacAdam: SDCM 3

CRI: ≥90

DURATA LED: 50.000 h



FOTO p. 314

2,890 Kg  
0,0183 m<sup>3</sup>  
Lunghezza cavo  
2150 mm

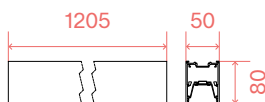

## LED SMD SAMSUNG (DRIVER TRIDONIC ON/OFF INCLUSO)

POTENZA	ANGOLO	LUMEN	CCT	FINITURA	CODICE	€
27 W	105°	3350 lm	3000 K	Bianco	192437	330
27 W	105°	3350 lm	3000 K	Nero	191997	330
27 W	105°	3600 lm	4000 K	Bianco	192482	330
27 W	105°	3600 lm	4000 K	Nero	192505	330

## DIMMABLE DRIVER\* (NON INCLUSO/OPTIONAL)

	POTENZA	OUTPUT	MISURE	CODICE	€
1-10V	28 W	500 mA	280 x 21 x 30 mm	216423	145
DALI/Push	27 W	500 mA	280 x 21 x 30 mm	216287	160

\*Gli alimentatori dimmerabili devono essere ordinati contestualmente al prodotto e verranno già inclusi all'interno degli apparecchi in sostituzione degli alimentatori on-off. La connessione in linea è disponibile soltanto per le versioni on-off dei prodotti.

4,420 Kg  
0,0257 m<sup>3</sup>  
Lunghezza cavo  
2150 mm

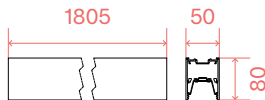

## LED SMD SAMSUNG (DRIVER TRIDONIC ON/OFF INCLUSO)

POTENZA	ANGOLO	LUMEN	CCT	FINITURA	CODICE	€
36 W	105°	4600 lm	3000 K	Bianco	192550	425
36 W	105°	4600 lm	3000 K	Nero	192567	425
36 W	105°	4750 lm	4000 K	Bianco	192604	425
36 W	105°	4750 lm	4000 K	Nero	192628	425

## DIMMABLE DRIVER\* (NON INCLUSO/OPTIONAL)

	POTENZA	OUTPUT	MISURE	CODICE	€
1-10V	39 W	700 mA	280 x 21 x 30 mm	216416	145
DALI/Push	38 W	700 mA	280 x 21 x 30 mm	216270	160

\*Gli alimentatori dimmerabili devono essere ordinati contestualmente al prodotto e verranno già inclusi all'interno degli apparecchi in sostituzione degli alimentatori on-off. La connessione in linea è disponibile soltanto per le versioni on-off dei prodotti.



# FLUO BI-EMISSION\*

SISTEMI



IP20 MacAdam: SDCM 3 CRI: ≥90 DURATA LED: 50.000 H



2,890 Kg  
0,0183 m<sup>3</sup>  
Lunghezza cavo  
2150 mm



LED SMD SAMSUNG (UP-LIGHT INCLUSA - DRIVER TRIDONIC ON/OFF INCLUSO)

POTENZA	ANGOLO	LUMEN	CCT	FINITURA	CODICE	€
40 W	105°	3300 lm	3000 K	Bianco	192666	425
40 W	105°	3300 lm	3000 K	Nero	192710	425
40 W	105°	3550 lm	4000 K	Bianco	192741	425
40 W	105°	3550 lm	4000 K	Nero	192758	425

UP-LIGHT INFO

KIT DIMMABLE DRIVER\*

POTENZA	ANGOLO	LUMEN	CCT		CODICE	€
13 W	105°	1800 lm	3000 K	1-10V	270692	230
13 W	105°	1900 lm	4000 K	DALI/Push	270876	260

\*Accensione separata dell'emissione diretta e indiretta (disponibile solo per versioni on-off). Regolazione in sincronia dell'emissione diretta e indiretta (versioni con dimmerazione 1-10V e Push). Gli alimentatori dimmerabili devono essere ordinati contestualmente al prodotto e verranno già inclusi all'interno degli apparecchi in sostituzione degli alimentatori on-off. La connessione in linea è disponibile soltanto per le versioni on-off dei prodotti.

4,420 Kg  
0,0269 m<sup>3</sup>  
Lunghezza cavo  
2150 mm



LED SMD SAMSUNG (UP-LIGHT INCLUSA - DRIVER TRIDONIC ON/OFF INCLUSO)

POTENZA	ANGOLO	LUMEN	CCT	FINITURA	CODICE	€
54 W	105°	4800 lm	3000 K	Bianco	192703	580
54 W	105°	4800 lm	3000 K	Nero	192697	580
54 W	105°	4950 lm	4000 K	Bianco	192673	580
54 W	105°	4950 lm	4000 K	Nero	192642	580

UP-LIGHT INFO

KIT DIMMABLE DRIVER\*

POTENZA	ANGOLO	LUMEN	CCT		CODICE	€
18 W	105°	2400 lm	3000 K	1-10V	270883	230
18 W	105°	2550 lm	4000 K	DALI/Push	270937	260

\*Accensione separata dell'emissione diretta e indiretta (disponibile solo per versioni on-off). Regolazione in sincronia dell'emissione diretta e indiretta (versioni con dimmerazione 1-10V e Push). Gli alimentatori dimmerabili devono essere ordinati contestualmente al prodotto e verranno già inclusi all'interno degli apparecchi in sostituzione degli alimentatori on-off. La connessione in linea è disponibile soltanto per le versioni on-off dei prodotti.

# FLUO - ASSEMBLY PLANS

## SISTEMI

---

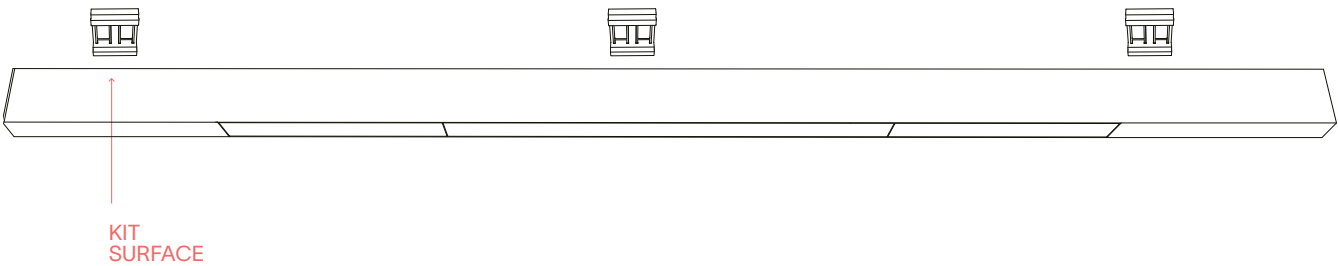
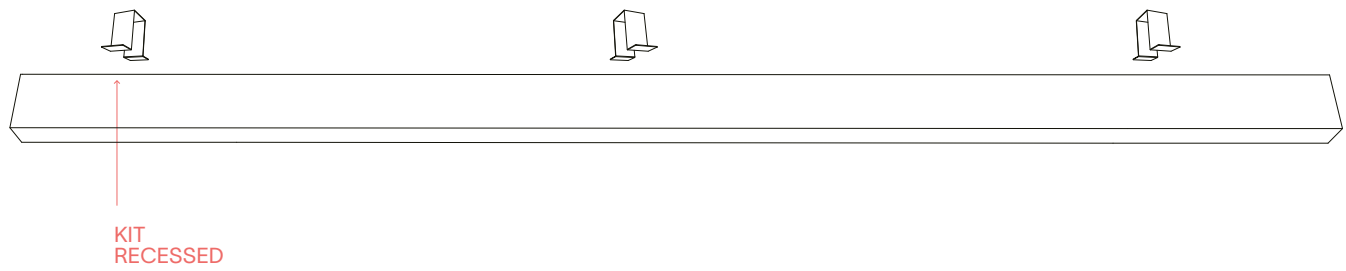
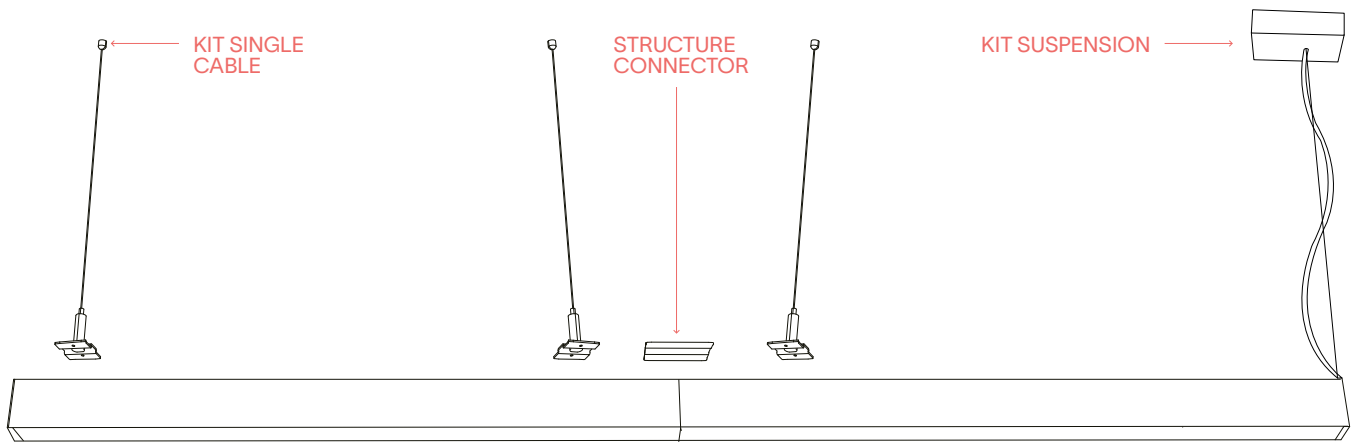

# FLUO - MOUNTING KIT

## SISTEMI

	NECESSARIO	N' CAVI	LUNGHEZZA CAVI	FINITURA	CODICE	€
KIT SUSPENSION		1	2000 mm	Bianco	277929	32
KIT SUSPENSION	SI	1	2000 mm	Nero	277912	32
KIT SUSPENSION	1 Kit x punto di alimentazione	1	5000 mm	Bianco	276342	43
KIT SUSPENSION		1	5000 mm	Nero	276335	43
KIT SINGLE CABLE	SI - 1 Kit x 600 mm	1	2000 mm		220826	13
KIT SINGLE CABLE	SI - 1 Kit x 600 mm	1	5000 mm		243665	20
KIT RECESSED	SI - 1 Kit x 600 mm	1			191188	25
KIT SURFACE	SI - 1 Kit x 600 mm	1			191171	25

# FLUO - OPTIONAL

## SISTEMI

0,140 Kg  
0,0001 m<sup>3</sup>

STRUCTURE CONNECTOR  
(LUNGHEZZA MAX PER PUNTO DI ALIMENTAZIONE:  
30 METRI)

NECESSARIO	CODICE	€
SI - 1 Kit x giunzione	191508	12

# FOX 8W

⊕ **ON-OFF** □ **1-10V/DALI**

**PROIETTORI**

IP20 MacAdam: SDCM 3 CRI:  $\geq 80 / \geq 90$  DURATA LED: 50.000 h [↑ FOTO p. 320](#)

## ON/OFF

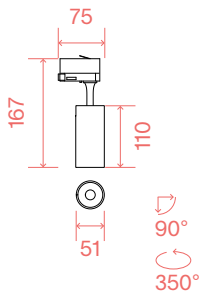

LED COB BRIDGELUX (DRIVER INCLUSO)

CRI  $\geq 80$

POTENZA	ANGOLO	CONTROLLO	LUMEN	CCT	BINARIO	FINITURA	CODICE	€
8 W	41°	On-Off	1050 lm	3000 K	3-Phase	Bianco	250410	45
8 W	41°	On-Off	1050 lm	3000 K	3-Phase	Nero	250403	45
8 W	41°	On-Off	1050 lm	3000 K	3-Phase	Ottone	283920	49
8 W	41°	On-Off	1100 lm	4000 K	3-Phase	Bianco	271453	45
8 W	41°	On-Off	1100 lm	4000 K	3-Phase	Nero	271446	45

## 1-10V

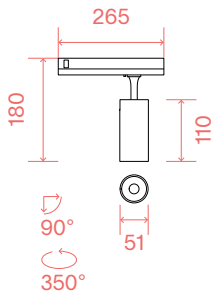

CRI  $\geq 90$

POTENZA	ANGOLO	CONTROLLO	LUMEN	CCT	BINARIO	FINITURA	CODICE	€
8 W	41°	On-Off	800 lm	2700 K	3-Phase	Bianco	340845	45
8 W	41°	On-Off	800 lm	2700 K	3-Phase	Nero	340838	45
8 W	41°	On-Off	950 lm	3000 K	3-Phase	Bianco	285368	45
8 W	41°	On-Off	950 lm	3000 K	3-Phase	Nero	285351	45
8 W	41°	On-Off	1000 lm	4000 K	3-Phase	Bianco	322339	45
8 W	41°	On-Off	1000 lm	4000 K	3-Phase	Nero	322322	45
8 W	41°	1-10V	900 lm	3000 K	3-Phase	Bianco	302546	85
8 W	41°	1-10V	900 lm	3000 K	3-Phase	Nero	302539	85
8 W	41°	1-10V	1050 lm	4000 K	3-Phase	Bianco	340869	85
8 W	41°	1-10V	1050 lm	4000 K	3-Phase	Nero	340852	85
8 W	41°	On-Off	950 lm	3000 K	1-Phase	Nero	348308	35

0,460 Kg  
0,0029 m<sup>3</sup>

	MODELLO	NECESSARIO	ANGOLO	DRIVER	FINITURA	CODICE	€
LENS	1-10V / DALI	NO	23°		Trasparente	302744	5
LENS	On/Off	NO	23°		Trasparente	349121	5
LINK SINGLE CONNECTION		NO		On/Off	Bianco	170145	23
LINK SINGLE CONNECTION		NO		On/Off	Nero	170152	23

# FOX 15W

 **ON-OFF**
 **1-10V/DALI**

**PROIETTORI**

IP20 MacAdam: SDCM 3 CRI:  $\geq 80 / \geq 90$  DURATA LED: 50.000 h

## ON/OFF

LED COB BRIDGELUX (DRIVER INCLUSO)

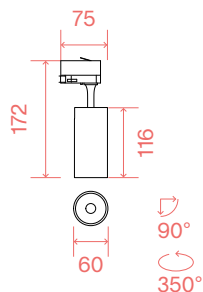

CRI  $\geq 80$

POTENZA	ANGOLO	CONTROLLO	LUMEN	CCT	BINARIO	FINITURA	CODICE	€
15 W	41°	On-Off	1850 lm	3000 K	3-Phase	Bianco	250434	50
15 W	41°	On-Off	1850 lm	3000 K	3-Phase	Nero	250427	50
15 W	41°	On-Off	1700 lm	3000 K	3-Phase	Ottone	283937	55
15 W	41°	On-Off	1900 lm	4000 K	3-Phase	Bianco	267784	50
15 W	41°	On-Off	1900 lm	4000 K	3-Phase	Nero	267777	50

## 1-10V/DALI

CRI  $\geq 90$

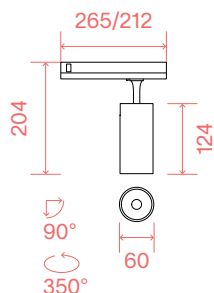

POTENZA	ANGOLO	CONTROLLO	LUMEN	CCT	BINARIO	FINITURA	CODICE	€
15 W	41°	On-Off	1450 lm	2700 K	3-Phase	Bianco	340883	50
15 W	41°	On-Off	1450 lm	2700 K	3-Phase	Nero	340876	50
15 W	41°	On-Off	1600 lm	3000 K	3-Phase	Bianco	285382	50
15 W	41°	On-Off	1600 lm	3000 K	3-Phase	Nero	285375	50
15 W	41°	On-Off	1750 lm	4000 K	3-Phase	Bianco	322360	50
15 W	41°	On-Off	1750 lm	4000 K	3-Phase	Nero	322346	50
15 W	41°	1-10V	1600 lm	3000 K	3-Phase	Bianco	302560	80
15 W	41°	1-10V	1600 lm	3000 K	3-Phase	Nero	302553	80
15 W	41°	1-10V	1750 lm	4000 K	3-Phase	Bianco	340906	80
15 W	41°	1-10V	1750 lm	4000 K	3-Phase	Nero	340890	80
15 W	41°	DALI	1600 lm	3000 K	3-Phase	Bianco	302584	110
15 W	41°	DALI	1600 lm	3000 K	3-Phase	Nero	302577	110
15 W	41°	DALI	1750 lm	4000 K	3-Phase	Bianco	340920	110
15 W	41°	DALI	1750 lm	4000 K	3-Phase	Nero	340913	110
15 W	41°	On-Off	1600 lm	3000 K	1-Phase	Nero	348315	40

0,600 Kg  
0,0037 m<sup>3</sup>

	MODELLO	NECESSARIO	ANGOLO	DRIVER	FINITURA	CODICE	€
LENS	1-10V / DALI	NO	15°		Trasparente	302751	5
LENS	On/Off	NO	15°		Trasparente	349138	5
LINK SINGLE CONNECTION		NO		On/Off	Bianco	170145	23
LINK SINGLE CONNECTION		NO		On/Off	Nero	170152	23

# FOX 25W

 **ON-OFF**
 **1-10V/DALI**

**PROIETTORI**

IP20 MacAdam: SDCM 3 CRI:  $\geq 80 / \geq 90$  DURATA LED: 50.000 h

## ON/OFF

LED COB BRIDGELUX (DRIVER INCLUSO)

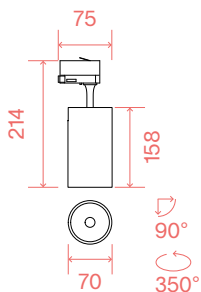

CRI  $\geq 80$

POTENZA	ANGOLO	CONTROLLO	LUMEN	CCT	BINARIO	FINITURA	CODICE	€
25 W	35°	On-Off	2900 lm	3000 K	3-Phase	Bianco	250458	55
25 W	35°	On-Off	2900 lm	3000 K	3-Phase	Nero	250441	55
25 W	35°	On-Off	2950 lm	3000 K	3-Phase	Ottone	283944	60
25 W	35°	On-Off	3050 lm	4000 K	3-Phase	Bianco	267807	55
25 W	35°	On-Off	3050 lm	4000 K	3-Phase	Nero	267791	55

## 1-10V/DALI

CRI  $\geq 90$

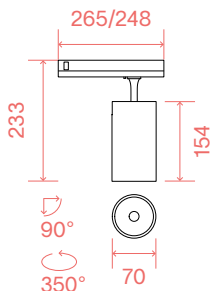

0,780 Kg  
0,0042 m<sup>3</sup>

POTENZA	ANGOLO	CONTROLLO	LUMEN	CCT	BINARIO	FINITURA	CODICE	€
25 W	35°	On-Off	2800 lm	2700 K	3-Phase	Bianco	340944	55
25 W	35°	On-Off	2800 lm	2700 K	3-Phase	Nero	340937	55
25 W	35°	On-Off	2950 lm	3000 K	3-Phase	Bianco	285405	55
25 W	35°	On-Off	2950 lm	3000 K	3-Phase	Nero	285399	55
25 W	35°	On-Off	3000 lm	4000 K	3-Phase	Bianco	322391	55
25 W	35°	On-Off	3000 lm	4000 K	3-Phase	Nero	322377	55
25 W	35°	1-10V	2900 lm	3000 K	3-Phase	Bianco	302607	100
25 W	35°	1-10V	2900 lm	3000 K	3-Phase	Nero	302591	100
25 W	35°	1-10V	3000 lm	4000 K	3-Phase	Bianco	340968	100
25 W	35°	1-10V	3000 lm	4000 K	3-Phase	Nero	340951	100
25 W	35°	DALI	2900 lm	3000 K	3-Phase	Bianco	302621	115
25 W	35°	DALI	2900 lm	3000 K	3-Phase	Nero	302614	115
25 W	35°	DALI	3000 lm	4000 K	3-Phase	Bianco	340982	115
25 W	35°	DALI	3000 lm	4000 K	3-Phase	Nero	340975	115
25 W	35°	On-Off	2950 lm	3000 K	1-Phase	Nero	348322	45

	MODELLO	NECESSARIO	ANGOLO	DRIVER	FINITURA	CODICE	€
LENS	1-10V / DALI	NO	15°		Trasparente	302768	5
LENS	On/Off	NO	15°		Trasparente	349145	5
LINK SINGLE CONNECTION		NO		On/Off	Bianco	170145	23
LINK SINGLE CONNECTION		NO		On/Off	Nero	170152	23

# GAME TRIM ROUND

DA INCASSO



IP20 / 65 UGR:<19 CRI: ≥90 DURATA LED: 50.000 h

↑ FOTO p. 342

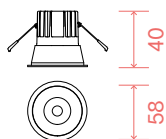

75

0,200 Kg  
0,0009 m<sup>3</sup>

## LED COB CREE (DRIVER ON/OFF INCLUSO)

POTENZA	ANGOLO	LUMEN	CCT	ESTERNO	FINITURA	CODICE	€
5,5 W	36°	650 lm	3000 K	Bianco	Bianco	337142	35
5,5 W	36°	650 lm	3000 K	Bianco	Oro	349084	35
5,5 W	36°	650 lm	3000 K	Nero	Nero	349060	35
5,5 W	36°	650 lm	3000 K	Nero	Oro	349077	35

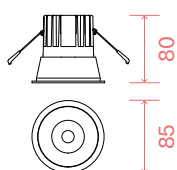

75

0,350 Kg  
0,0016 m<sup>3</sup>

## LED COB CREE (DRIVER ON/OFF INCLUSO)

POTENZA	ANGOLO	LUMEN	CCT	ESTERNO	FINITURA	CODICE	€
11 W	36°	900 lm	2700 K	Bianco	Bianco	285429	45
11 W	36°	900 lm	2700 K	Bianco	Oro	341347	45
11 W	36°	950 lm	3000 K	Bianco	Argento	192284	45
11 W	36°	950 lm	3000 K	Bianco	Bianco	192291	45
11 W	36°	950 lm	3000 K	Bianco	Nero	192277	45
11 W	36°	950 lm	3000 K	Bianco	Oro	192307	45
11 W	36°	1100 lm	4000 K	Bianco	Bianco	267975	45
11 W	36°	1100 lm	4000 K	Bianco	Oro	341361	45
11 W	36°	900 lm	2700 K	Nero	Nero	285412	45
11 W	36°	900 lm	2700 K	Nero	Oro	341330	45
11 W	36°	950 lm	3000 K	Nero	Argento	192321	45
11 W	36°	950 lm	3000 K	Nero	Bianco	192338	45
11 W	36°	950 lm	3000 K	Nero	Nero	192314	45
11 W	36°	950 lm	3000 K	Nero	Oro	192345	45
11 W	36°	1100 lm	4000 K	Nero	Nero	267968	45
11 W	36°	1100 lm	4000 K	Nero	Oro	341354	45

## IP65

POTENZA	ANGOLO	LUMEN	CCT	ESTERNO	FINITURA	CODICE	€
11 W	36°	950 lm	3000 K	Nero	Bianco	313191	75
11 W	36°	950 lm	3000 K	Nero	Nero	327754	75

## DIMMABLE DRIVER\* (NON INCLUSO/OPTIONAL) SOLO 11 W

	POTENZA	OUTPUT	MISURE	CODICE	€
1-10V/Push	20 W	250 mA	111 x 22 x 52 mm	217253	60
DALI/Push	12 W	250 mA	132 x 20 x 30 mm	202396	55

\*Gli alimentatori dimmerabili devono essere ordinati contestualmente al prodotto e verranno già inclusi all'interno degli apparecchi in sostituzione degli alimentatori on-off.

# GAME TRIM ROUND

DA INCASSO



IP20 UGR:<19 CRI:≥90 DURATA LED: 50.000 h

↑ FOTO p. 342

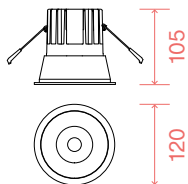

① 110  
0,660 Kg  
0,0033 m<sup>3</sup>

## LED COB CREE (DRIVER ON/OFF INCLUSO)

POTENZA	ANGOLO	LUMEN	CCT	ESTERNO	FINITURA	CODICE	€
20 W	27°	2100 lm	2700 K	Bianco	Bianco	341408	90
20 W	27°	2100 lm	2700 K	Bianco	Oro	341392	90
20 W	27°	2250 lm	3000 K	Bianco	Bianco	273174	90
20 W	27°	2250 lm	3000 K	Bianco	Oro	341422	90
20 W	27°	2100 lm	2700 K	Nero	Nero	341378	90
20 W	27°	2100 lm	2700 K	Nero	Oro	341385	90
20 W	27°	2250 lm	3000 K	Nero	Nero	273167	90
20 W	27°	2250 lm	3000 K	Nero	Oro	341415	90



# GAME TRIM SQUARE

DA INCASSO

IP20 / 65 UGR:<19 CRI: ≥90 DURATA LED: 50.000 h

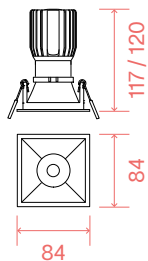

75x75

0,310 Kg  
0,0016 m<sup>3</sup>

## LED COB CREE (DRIVER ON/OFF INCLUSO)

POTENZA	ANGOLO	LUMEN	CCT	ESTERNO	FINITURA	CODICE	€
11 W	36°	900 lm	2700 K	Bianco	Bianco	285443	50
11 W	36°	950 lm	3000 K	Bianco	Bianco	192376	50
11 W	36°	950 lm	3000 K	Bianco	Nero	192352	50
11 W	36°	900 lm	2700 K	Nero	Nero	285436	50
11 W	36°	950 lm	3000 K	Nero	Bianco	192406	50
11 W	36°	950 lm	3000 K	Nero	Nero	192383	50

## IP65

POTENZA	ANGOLO	LUMEN	CCT	FINITURA	FINITURA	CODICE	€
11 W	36°	950 lm	3000 K	Nero	Bianco	313207	75
11 W	36°	950 lm	3000 K	Nero	Nero	327761	75

## DIMMABLE DRIVER\* (NON INCLUSO/OPTIONAL)

	POTENZA	OUTPUT	MISURE	CODICE	€
1-10V/Push	20 W	250 mA	111 x 22 x 52 mm	217253	60
DALI/Push	12 W	250 mA	132 x 20 x 30 mm	202396	55

\*Gli alimentatori dimmerabili devono essere ordinati contestualmente al prodotto e verranno già inclusi all'interno degli apparecchi in sostituzione degli alimentatori on-off.

# GAME TRIMLESS

DA INCASSO

IP20 UGR:<19 CRI:≥90 DURATA LED: 50.000 h

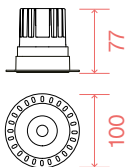

① 75

0,300 Kg  
0,0011 m<sup>3</sup>

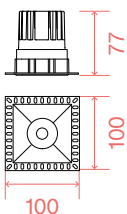

① 75x75

0,300 Kg  
0,0011 m<sup>3</sup>

## LED COB CREE (DRIVER ON/OFF INCLUSO)

POTENZA	ANGOLO	LUMEN	CCT	FINITURA	CODICE	€
11 W	36°	950 lm	3000 K	Bianco	319667	50
11 W	36°	950 lm	3000 K	Nero	319650	50

## LED COB CREE (DRIVER ON/OFF INCLUSO)

POTENZA	ANGOLO	LUMEN	CCT	FINITURA	CODICE	€
11 W	36°	950 lm	3000 K	Bianco	319681	50
11 W	36°	950 lm	3000 K	Nero	319674	50

## DIMMABLE DRIVER\* (NON INCLUSO/OPTIONAL)

	POTENZA	OUTPUT	MISURE	CODICE	€
1-10V/Push	20 W	250 mA	111 x 22 x 52 mm	217253	60
DALI/Push	12 W	250 mA	132 x 20 x 30 mm	202396	55

\*Gli alimentatori dimmerabili devono essere ordinati contestualmente al prodotto e verranno già inclusi all'interno degli apparecchi in sostituzione degli alimentatori on-off.

# LIKA TRIM

DA INCASSO

□ IP20 UGR:<16 CRI: ≥90 DURATA LED: 50.000 h

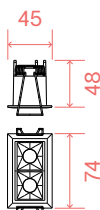

□ 68x37

0,180 Kg  
0,0009 m<sup>3</sup>

## LED SMD OSRAM (DRIVER ON/OFF INCLUSO)

POTENZA	ANGOLO	LUMEN	CCT	FINITURA	CODICE	€
5,5 W	29°	340 lm	2700 K	Bianco + Nero	341729	45
5,5 W	29°	350 lm	3000 K	Bianco + Nero	206196	45
5,5 W	29°	400 lm	4000 K	Bianco + Nero	267869	45

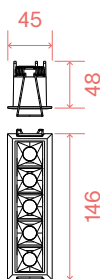

□ 140x37

0,320 Kg  
0,0013 m<sup>3</sup>

## LED SMD OSRAM (DRIVER ON/OFF INCLUSO)

POTENZA	ANGOLO	LUMEN	CCT	FINITURA	CODICE	€
12 W	29°	850 lm	2700 K	Bianco + Nero	341736	70
12 W	29°	880 lm	3000 K	Bianco + Nero	206219	70
12 W	29°	1000 lm	4000 K	Bianco + Nero	267876	70

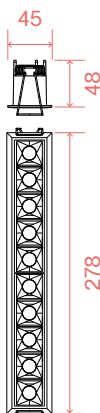

□ 273x37

0,580 Kg  
0,0022 m<sup>3</sup>

## LED SMD OSRAM (DRIVER ON/OFF INCLUSO)

POTENZA	ANGOLO	LUMEN	CCT	FINITURA	CODICE	€
20 W	29°	1700 lm	2700 K	Bianco + Nero	341743	110
20 W	29°	1750 lm	3000 K	Bianco + Nero	206233	110
20 W	29°	2000 lm	4000 K	Bianco + Nero	267883	110

## DIMMABLE DRIVER\* (NON INCLUSO/OPTIONAL)

MODELLO	CONTROLLO	POTENZA	OUTPUT	MISURE	CODICE	€
5,5/12 W	DALI	12 W	700 mA	132 x 20 x 30 mm	267982	56
20 W	DALI/Push	25 W	600 mA	135 x 24 x 72 mm	268002	75

\* Gli alimentatori dimmerabili devono essere ordinati contestualmente al prodotto e verranno già inclusi all'interno degli apparecchi in sostituzione degli alimentatori on-off.

# LIKA TRIMLESS

DA INCASSO



IP20 UGR:<16 CRI:≥90 DURATA LED: 50.000 h

↑ FOTO p. 348

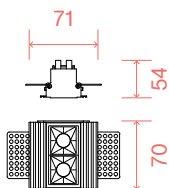

75x70

0,220 Kg  
0,0005 m<sup>3</sup>

## LED SMD OSRAM (DRIVER ON/OFF INCLUSO)

POTENZA	ANGOLO	LUMEN	CCT	FINITURA	CODICE	€
5,5 W	29°	340 lm	2700 K	Nero	341750	60
5,5 W	29°	350 lm	3000 K	Nero	206202	60
5,5 W	29°	400 lm	4000 K	Nero	267890	60

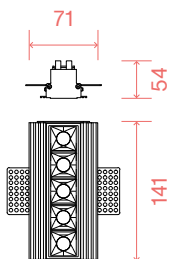

145x70

0,450 Kg  
0,0013 m<sup>3</sup>

## LED SMD OSRAM (DRIVER ON/OFF INCLUSO)

POTENZA	ANGOLO	LUMEN	CCT	FINITURA	CODICE	€
12,5 W	29°	850 lm	2700 K	Nero	341767	95
12,5 W	29°	880 lm	3000 K	Nero	206226	95
12,5 W	29°	1000 lm	4000 K	Nero	267906	95

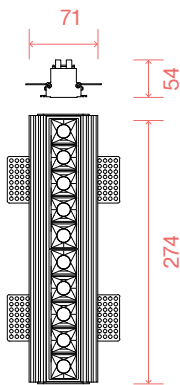

278x70

0,760 Kg  
0,0022 m<sup>3</sup>

## LED SMD OSRAM (DRIVER ON/OFF INCLUSO)

POTENZA	ANGOLO	LUMEN	CCT	FINITURA	CODICE	€
19,5 W	29°	1700 lm	2700 K	Nero	341774	150
19,5 W	29°	1750 lm	3000 K	Nero	206240	150
19,5 W	29°	2000 lm	4000 K	Nero	267913	150

## DIMMABLE DRIVER\* (NON INCLUSO/OPTIONAL)

MODELLO	CONTROLLO	POTENZA	OUTPUT	MISURE	CODICE	€
5,5/12 W	DALI	12 W	700 mA	132 x 20 x 30 mm	267982	56
20 W	DALI/Push	25 W	600 mA	135 x 24 x 72 mm	268002	75

\* Gli alimentatori dimmerabili devono essere ordinati contestualmente al prodotto e verranno già inclusi all'interno degli apparecchi in sostituzione degli alimentatori on-off.

# LIKA SLIM

DA INCASSO

↑ IP20 UGR:<19 CRI: ≥90 DURATA LED: 50.000 h

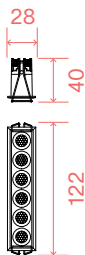

117x23

0,180 Kg  
0,0013 m<sup>3</sup>

## LED SMD (DRIVER ON/OFF INCLUSO)

POTENZA	ANGOLO	LUMEN	CCT	FINITURA	CODICE	€
10 W	32°	900 lm	2700 K	Nero	341644	66
10 W	32°	1000 lm	3000 K	Bianco	327501	66
10 W	32°	1000 lm	3000 K	Nero	305813	66
10 W	32°	1200 lm	4000 K	Bianco	341675	66
10 W	32°	1200 lm	4000 K	Nero	341668	66

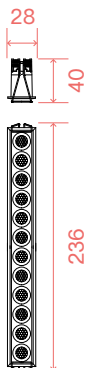

231x23

0,300 Kg  
0,0022 m<sup>3</sup>

## LED SMD (DRIVER ON/OFF INCLUSO)

POTENZA	ANGOLO	LUMEN	CCT	FINITURA	CODICE	€
20 W	32°	1800 lm	2700 K	Nero	341682	110
20 W	32°	2000 lm	3000 K	Bianco	327518	110
20 W	32°	2000 lm	3000 K	Nero	305837	110
20 W	32°	2400 lm	4000 K	Bianco	341712	110
20 W	32°	2400 lm	4000 K	Nero	341705	110

# LINK 3-PHASE TRIMLESS ON/OFF

BINARI

↑ IP20

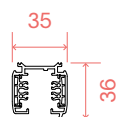
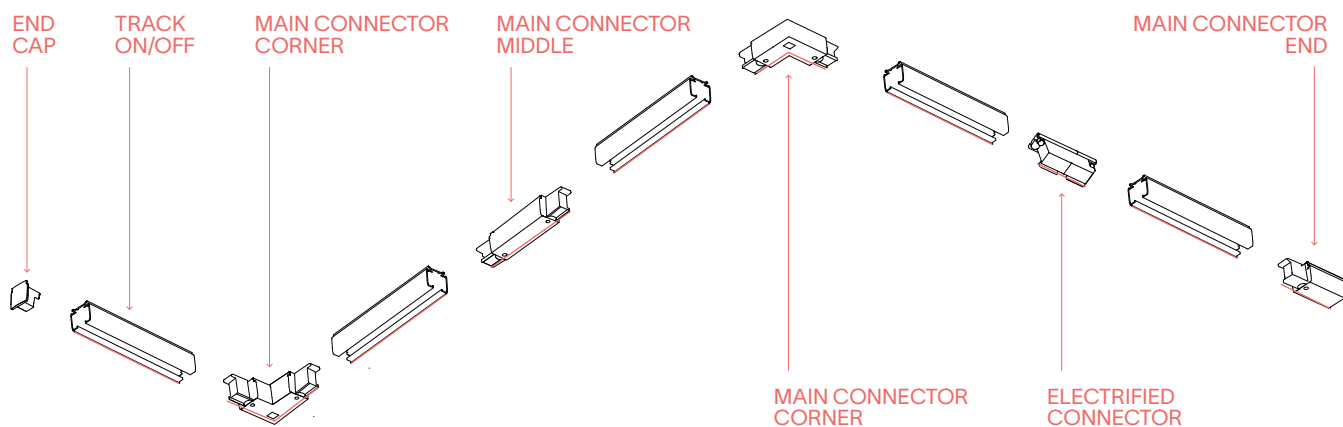

## TRACK

LUNGHEZZA	PESO	VOLUME	FINITURA	CODICE	€
1000 mm	0,94 Kg	0,0016 m <sup>3</sup>	Bianco	243269	30
1000 mm	0,94 Kg	0,0016 m <sup>3</sup>	Nero	243252	30
2000 mm	1,72 Kg	0,0074 m <sup>3</sup>	Bianco	187976	60
2000 mm	1,72 Kg	0,0074 m <sup>3</sup>	Nero	187983	60
3000 mm	2,55 Kg	0,0110 m <sup>3</sup>	Bianco	187990	95
3000 mm	2,55 Kg	0,0110 m <sup>3</sup>	Nero	188003	95

	NECESSARIO	N° CAVI	LUNGHEZZA CAVI	FINITURA	CODICE	€
KIT SURFACE	SI - 1 Kit x 1000 mm			Bianco	169972	5
KIT SURFACE	SI - 1 Kit x 1000 mm			Nero	169989	5
SUSPENSION KIT	SI - 1 Kit x 1000 mm	1	3000 mm	Bianco	242705	13
SUSPENSION KIT	SI - 1 Kit x 1000 mm	1	3000 mm	Nero	243283	13
SUSPENSION KIT	SI - 1 Kit x 1000 mm	1	5000 mm	Bianco	243245	15
SUSPENSION KIT	SI - 1 Kit x 1000 mm	1	5000 mm	Nero	243238	15
END CAP	SI			Bianco	169613	2
END CAP	SI			Nero	169620	2

# LINK 3-PHASE TRIMLESS ON/OFF

BINARI

↑ IP20

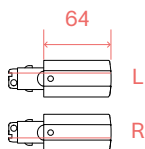

## MAIN CONNECTOR END

LATO	FINITURA	CODICE	€
L	Bianco	169583	9
L	Nero	169576	9
R	Bianco	169590	9
R	Nero	169606	9

0,060 Kg  
0,0002 m<sup>3</sup>

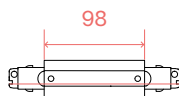

## MAIN CONNECTOR MIDDLE

FINITURA	CODICE	€
Bianco	227580	17
Nero	227597	17

0,120 Kg  
0,0004 m<sup>3</sup>

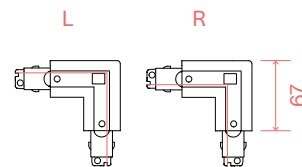

## MAIN CONNECTOR CORNER

LATO	FINITURA	CODICE	€
L	Bianco	169705	17
L	Nero	169712	17
R	Bianco	169736	17
R	Nero	169729	17

0,110 Kg  
0,0005 m<sup>3</sup>

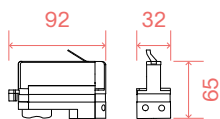

## TRACK ADAPTOR

FINITURA	CODICE	€
Bianco	194257	9
Nero	194301	9

0,080 Kg  
0,0002 m<sup>3</sup>

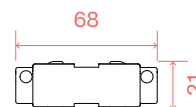

## ELECTRIFIED CONNECTOR

FINITURA	CODICE	€
Bianco	169637	7
Nero	169644	7

0,030 Kg  
0,0001 m<sup>3</sup>

# LINK 3-PHASE TRIMLESS DALI - 1-10V

BINARI

↑ IP20

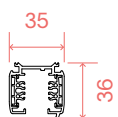
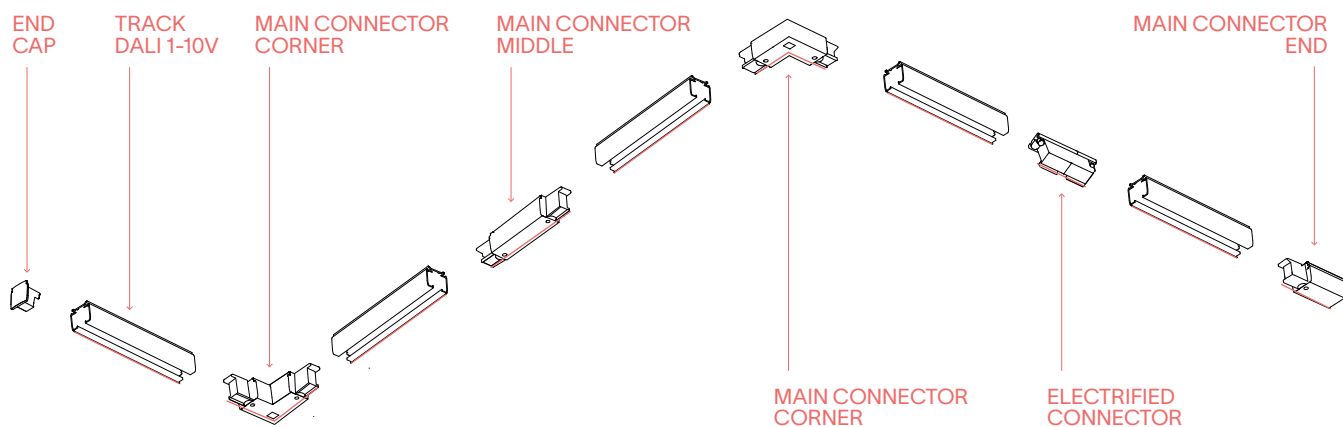

## TRACK

LUNGHEZZA	PESO	VOLUME	FINITURA	CODICE	€
1000 mm	0,94 Kg	0,0016 m <sup>3</sup>	Bianco	246468	38
1000 mm	0,94 Kg	0,0016 m <sup>3</sup>	Nero	246451	38
2000 mm	1,93 Kg	0,0032 m <sup>3</sup>	Bianco	247007	80
2000 mm	1,93 Kg	0,0032 m <sup>3</sup>	Nero	246901	80
3000 mm	2,87 Kg	0,0048 m <sup>3</sup>	Bianco	247625	115
3000 mm	2,87 Kg	0,0048 m <sup>3</sup>	Nero	247618	115

	NECESSARIO	N° CAVI	LUNGHEZZA CAVI	FINITURA	CODICE	€
KIT SURFACE	SI - 1 Kit x 1000 mm			Bianco	169972	5
KIT SURFACE	SI - 1 Kit x 1000 mm			Nero	169989	5
SUSPENSION KIT	SI - 1 Kit x 1000 mm	1	3000 mm	Bianco	242705	13
SUSPENSION KIT	SI - 1 Kit x 1000 mm	1	3000 mm	Nero	243283	13
SUSPENSION KIT	SI - 1 Kit x 1000 mm	1	5000 mm	Bianco	243245	15
SUSPENSION KIT	SI - 1 Kit x 1000 mm	1	5000 mm	Nero	243238	15
END CAP	SI			Bianco	169613	2
END CAP	SI			Nero	169620	2



# LINK 3-PHASE TRIMLESS DALI - 1-10V

BINARI

↑ IP20

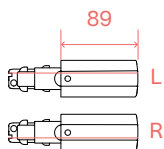

## MAIN CONNECTOR END

LATO	FINITURA	CODICE	€
L	Bianco	246529	13
L	Nero	246512	13
R	Bianco	246543	13
R	Nero	246536	13

0,079 Kg  
0,0002 m<sup>3</sup>

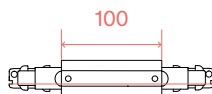

## MAIN CONNECTOR MIDDLE

FINITURA	CODICE	€
Bianco	246581	25
Nero	246574	25

0,129 Kg  
0,0004 m<sup>3</sup>

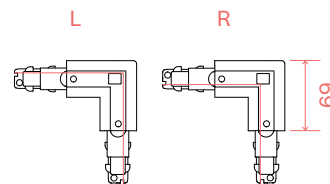

## MAIN CONNECTOR CORNER

LATO	FINITURA	CODICE	€
L	Bianco	246604	25
L	Nero	246598	25
R	Bianco	246628	25
R	Nero	246611	25

0,130 Kg  
0,0006 m<sup>3</sup>

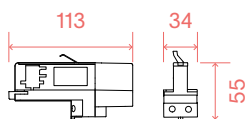

## TRACK ADAPTOR

FINITURA	CODICE	€
Bianco	246505	15
Nero	246499	15

0,063 Kg  
0,0003 m<sup>3</sup>

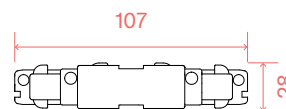

## ELECTRIFIED CONNECTOR

FINITURA	CODICE	€
Bianco	246567	9
Nero	246550	9

0,050 Kg  
0,0001 m<sup>3</sup>

# LINK 3-PHASE TRIM ON/OFF

BINARI

IP20

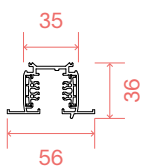
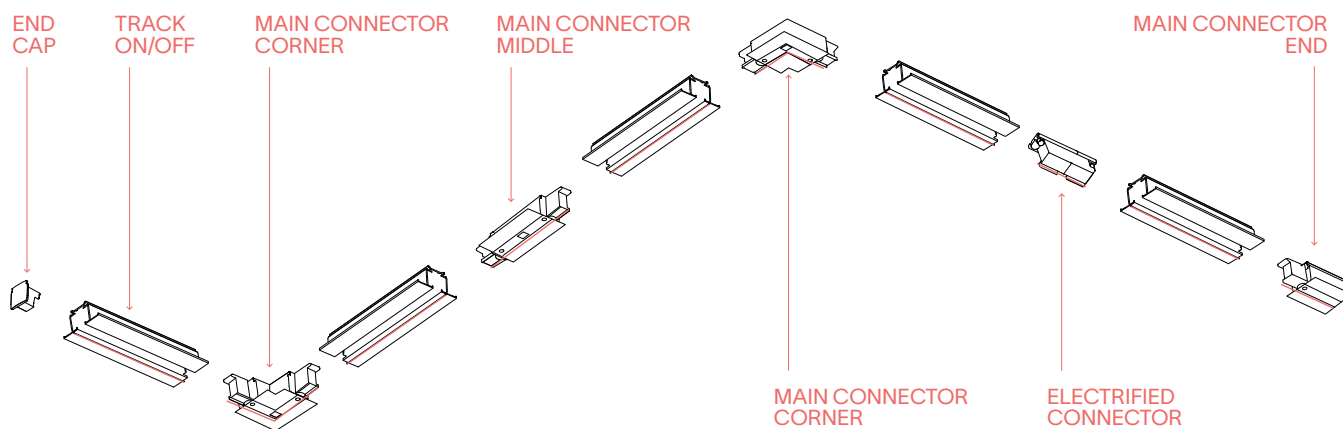

## TRACK

LUNGHEZZA	PESO	VOLUME	FINITURA	CODICE	€
2000 mm	1,92 Kg	0,0132 m <sup>3</sup>	Bianco	188010	60
2000 mm	1,92 Kg	0,0132 m <sup>3</sup>	Nero	188027	60

	NECESSARIO	FINITURA	CODICE	€
KIT RECESSED	SI - 1 Kit x 1000 mm	Alluminio	188195	5
END CAP	SI	Bianco	169613	2
END CAP	SI	Nero	169620	2

# LINK 3-PHASE TRIM ON/OFF

BINARI

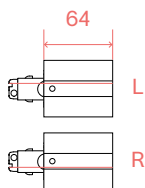

MAIN CONNECTOR END

LATO	FINITURA	CODICE	€
L	Bianco	188072	7
L	Nero	188089	7
R	Bianco	188058	7
R	Nero	188065	7

0,070 Kg  
0,0002 m<sup>3</sup>

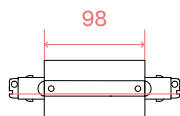

MAIN CONNECTOR MIDDLE

FINITURA	CODICE	€
Bianco	227689	15
Nero	227672	15

0,130 Kg  
0,0004 m<sup>3</sup>

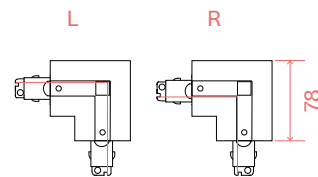

MAIN CONNECTOR CORNER

LATO	FINITURA	CODICE	€
L	Bianco	188119	15
L	Nero	188126	15
R	Bianco	188096	15
R	Nero	188102	15

0,120 Kg  
0,0006 m<sup>3</sup>

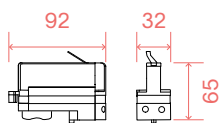

TRACK ADAPTOR

FINITURA	CODICE	€
Bianco	194257	9
Nero	194301	9

0,080 Kg  
0,0002 m<sup>3</sup>

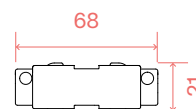

ELECTRIFIED CONNECTOR

FINITURA	CODICE	€
Bianco	169637	7
Nero	169644	7

0,030 Kg  
0,0001 m<sup>3</sup>

# LINK 3-PHASE TRIM DALI - 1-10V

BINARI

IP20

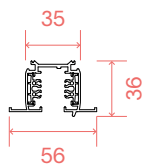
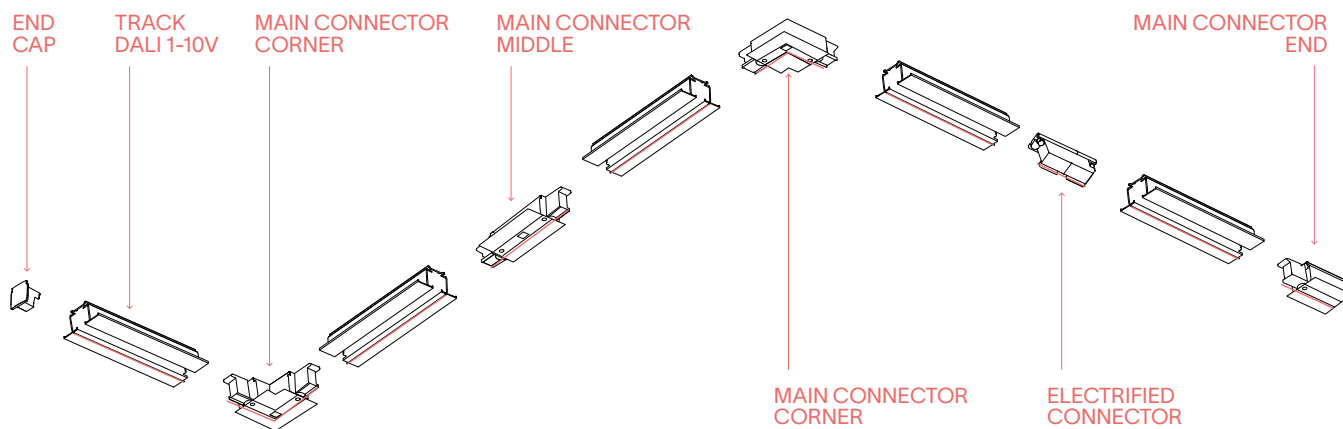

## TRACK

LUNGHEZZA	PESO	VOLUME	FINITURA	CODICE	€
2000 mm	2,11 Kg	0,0048 m <sup>3</sup>	Bianco	246895	75
2000 mm	2,11 Kg	0,0048 m <sup>3</sup>	Nero	249629	75

	NECESSARIO	FINITURA	CODICE	€
KIT RECESSED	SI - 1 Kit x 1000 mm	Alluminio	188195	5
END CAP	SI	Bianco	169613	2
END CAP	SI	Nero	169620	2

# LINK 3-PHASE TRIM DALI - 1-10V

BINARI

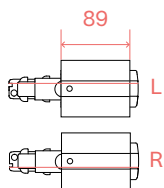

MAIN CONNECTOR END

LATO	FINITURA	CODICE	€
L	Bianco	256085	10
L	Nero	256078	10
R	Bianco	256146	10
R	Nero	256122	10

0,089 Kg  
0,0004 m<sup>3</sup>

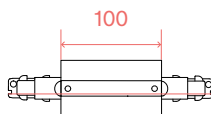

MAIN CONNECTOR MIDDLE

FINITURA	CODICE	€
Bianco	256115	25
Nero	256092	25

0,150 Kg  
0,0005 m<sup>3</sup>

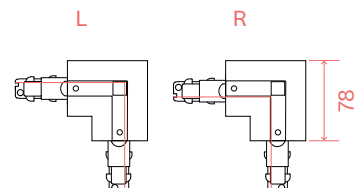

MAIN CONNECTOR CORNER

LATO	FINITURA	CODICE	€
L	Bianco	256030	25
L	Nero	255996	25
R	Bianco	256061	25
R	Nero	256047	25

0,150 Kg  
0,0006 m<sup>3</sup>

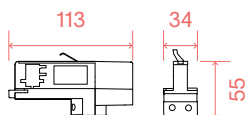

TRACK ADAPTOR

FINITURA	CODICE	€
Bianco	246505	15
Nero	246499	15

0,063 Kg  
0,0003 m<sup>3</sup>

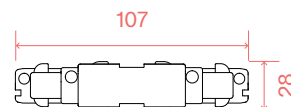

ELECTRIFIED CONNECTOR

FINITURA	CODICE	€
Bianco	246567	9
Nero	246550	9

0,050 Kg  
0,0001 m<sup>3</sup>

# LINK 1-PHASE SURFACE ON/OFF

BINARI

IP20

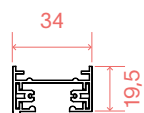
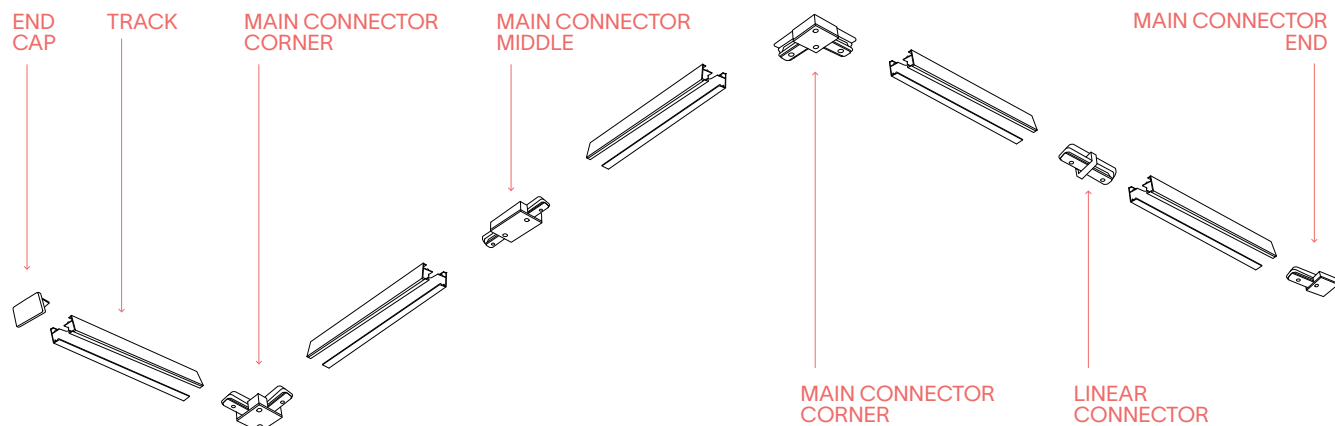

## TRACK

LUNGHEZZA	PESO	VOLUME	FINITURA	CODICE	€
1000 mm	0,42 Kg	0,0007 m <sup>3</sup>	Nero	337371	13
2000 mm	0,83 Kg	0,0017 m <sup>3</sup>	Nero	342801	24
3000 mm	1,22 Kg	0,0022 m <sup>3</sup>	Nero	344973	35

	NECESSARIO	FINITURA	CODICE	€
END CAP	SI	Nero	337395	3

# LINK 1-PHASE SURFACE ON/OFF

BINARI

 IP20

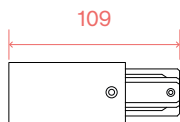

MAIN CONNECTOR

FINITURA	CODICE	€
Nero	337388	3

0,060 Kg  
0,0001 m<sup>3</sup>

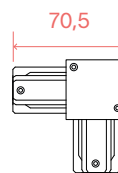

MAIN CONNECTOR CORNER

FINITURA	CODICE	€
Nero	337401	3

0,060 Kg  
0,0001 m<sup>3</sup>

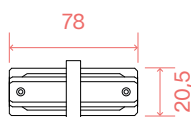

LINEAR CONNECTOR

FINITURA	CODICE	€
Nero	337418	3

0,040 Kg  
0,0001 m<sup>3</sup>



MAIN CONNECTOR MIDDLE

FINITURA	CODICE	€
Nero	337425	5

0,070 Kg  
0,0001 m<sup>3</sup>

# LINK 1-PHASE RECESSED

BINARI

IP20

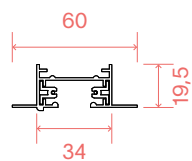
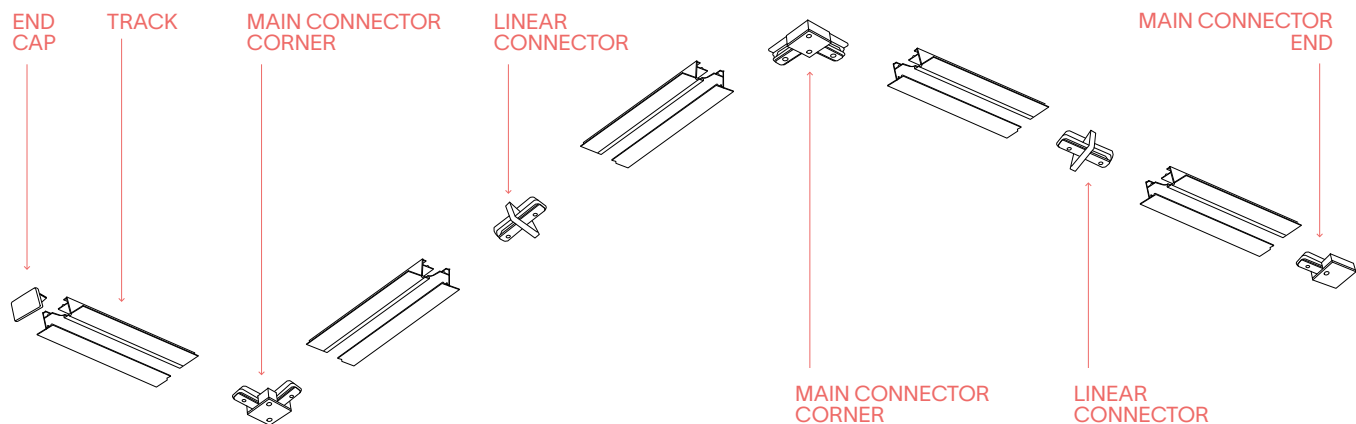

## TRACK

LUNGHEZZA	PESO	VOLUME	FINITURA	CODICE	€
1000 mm	0,49 Kg	0,0013 m <sup>3</sup>	Nero	342818	17
2000 mm	0,94 Kg	0,0027 m <sup>3</sup>	Nero	342825	32
3000 mm	1,39 Kg	0,0041 m <sup>3</sup>	Nero	344966	47

	NECESSARIO	FINITURA	CODICE	€
KIT RECESSED	SI - 1 Kit x 1000 mm	Alluminio	188195	5
END CAP	SI	Nero	337395	3



# LINK 1-PHASE RECESSED

BINARI

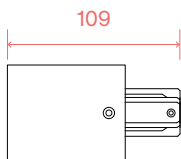

MAIN CONNECTOR

FINITURA	CODICE	€
Nero	342832	3

0,070 Kg  
0,0001 m<sup>3</sup>

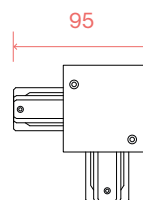

MAIN CONNECTOR CORNER

FINITURA	CODICE	€
Nero	342849	4

0,100 Kg  
0,0001 m<sup>3</sup>

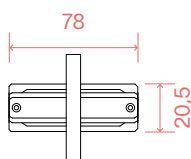

LINEAR CONNECTOR

FINITURA	CODICE	€
Nero	342856	3

0,040 Kg  
0,0001 m<sup>3</sup>



2,550 Kg  
0,0158 m<sup>3</sup>  
Lunghezza cavo  
1500 mm

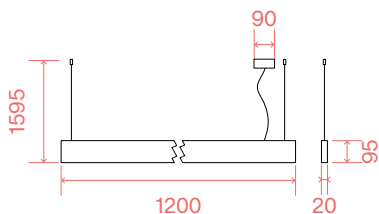

### LED SMD (UP-LIGHT INCLUSA - DRIVER 1-10V INCLUSO)

POTENZA	ANGOLO	LUMEN	CCT	FINITURA	CODICE	€
32 W	104°	1500 lm	3000 K	Bianco	241968	220
32 W	104°	1500 lm	3000 K	Nero	241975	220
32 W	104°	1750 lm	4000 K	Bianco	268231	220
32 W	104°	1750 lm	4000 K	Nero	268217	220

### UP-LIGHT INFO

POTENZA	ANGOLO	LUMEN	CCT
32 W	104°	1500 lm	3000 K
32 W	104°	1750 lm	4000 K

### CORNER (OPTIONAL - UP-LIGHT NON INCLUSA)

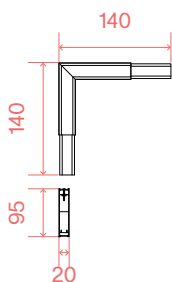

POTENZA	ANGOLO	LUMEN	CCT	FINITURA	CODICE	€
5,5 W	104°	640 lm	3000 K	Bianco	241999	46
5,5 W	104°	640 lm	3000 K	Nero	242002	46
5,5 W	104°	730 lm	4000 K	Bianco	268149	46
5,5 W	104°	730 lm	4000 K	Nero	268118	46

### STRUCTURE CONNECTOR

0,260 Kg  
0,0023 m<sup>3</sup>

NECESSARIO	CODICE	€
SI - 1 Kit x giunzione	241982	6

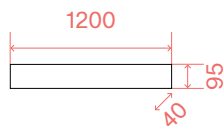

1,250 Kg  
0,0158 m<sup>3</sup>  
LED 32W  
3000/3500 lm

FINITURA	LUMEN	CODICE	€
Bianco	3000K	233840	210
Bianco	4000K	268095	210
Nero	3000K	242019	210
Nero	4000K	268071	210

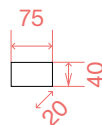

CONNECTOR  
(NON INCLUSO/NECESSARIO)  
cod. 233666, € 6



# NOVA

DA INCASSO



IP20

CRI: ≥90

DURATA LED: 50.000 h



FOTO p. 352

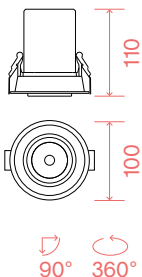

90

0,550 Kg  
0,0016 m<sup>3</sup>

## LED COB PHILIPS (DRIVER ON/OFF INCLUSO - UGR <19)

POTENZA	ANGOLO	LUMEN	CCT	FINITURA	CODICE	€
12 W	38°	1100 lm	2700 K	Bianco	341859	78
12 W	38°	1100 lm	2700 K	Nero	341842	78
12 W	38°	1200 lm	3000 K	Bianco	248165	78
12 W	38°	1200 lm	3000 K	Nero	248189	78
12 W	38°	1300 lm	4000 K	Bianco	267937	78
12 W	38°	1300 lm	4000 K	Nero	267920	78

## DIMMABLE DRIVER\* (NON INCLUSO/OPTIONAL)

POTENZA	OUTPUT	MISURE	CODICE	€
1-10V / Push 15 W	300 mA	111 x 22 x 52 mm	243993	60
DALI/ Push 12 W	300 mA	132 x 20 x 30 mm	243986	55

\* Gli alimentatori dimmerabili devono essere ordinati contestualmente al prodotto e verranno già inclusi all'interno degli apparecchi in sostituzione degli alimentatori on-off.

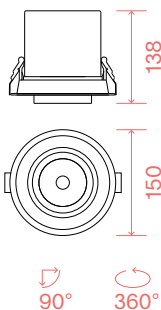

140

1,160 Kg  
0,0039 m<sup>3</sup>

## LED COB PHILIPS (DRIVER ON/OFF INCLUSO - UGR <22)

POTENZA	ANGOLO	LUMEN	CCT	FINITURA	CODICE	€
30 W	38°	3000 lm	2700 K	Bianco	341873	125
30 W	38°	3000 lm	2700 K	Nero	341866	125
30 W	38°	3150 lm	3000 K	Bianco	248172	125
30 W	38°	3150 lm	3000 K	Nero	248196	125
30 W	38°	3300 lm	4000 K	Bianco	267951	125
30 W	38°	3300 lm	4000 K	Nero	267944	125

## DIMMABLE DRIVER\* (NON INCLUSO/OPTIONAL)

POTENZA	OUTPUT	MISURE	CODICE	€
1-10V / Push 36 W	700 mA	167 x 32 x 41 mm	248370	100
DALI/ Push 36 W	700 mA	135 x 24 x 72 mm	248592	100

\* Gli alimentatori dimmerabili devono essere ordinati contestualmente al prodotto e verranno già inclusi all'interno degli apparecchi in sostituzione degli alimentatori on-off.

MODELLO	NECESSARIO	ANGOLO	CODICE	€
LENS Nova 12W	NO	15°	244013	8
LENS Nova 30W	NO	15°	248608	12

# QUICK 15W

PROIETTORI



IP20

MacAdam: SDCM 3

CRI:  $\geq 80$  /  $\geq 90$

DURATA LED: 50.000 h

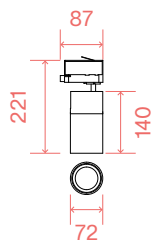

0,760 Kg  
0,0038 m<sup>3</sup>

## LED COB CITIZEN

CRI  $\geq 80$

POTENZA	ANGOLO	LUMEN	CCT	BINARIO	FINITURA	CODICE	€
15 W	30°	1800 lm	3000 K	3-Phase	Bianco	222509	145
15 W	30°	1800 lm	3000 K	3-Phase	Nero	222523	145
15 W	30°	1950 lm	4000 K	3-Phase	Bianco	222530	145
15 W	30°	1950 lm	4000 K	3-Phase	Nero	222547	145

CRI  $\geq 90$

POTENZA	ANGOLO	LUMEN	CCT	BINARIO	FINITURA	CODICE	€
15 W	30°	1500 lm	3000 K	3-Phase	Bianco	222554	145
15 W	30°	1500 lm	3000 K	3-Phase	Nero	222561	145
15 W	30°	1600 lm	4000 K	3-Phase	Bianco	222578	145
15 W	30°	1600 lm	4000 K	3-Phase	Nero	222585	145

	NECESSARIO	ANGOLO	FINITURA	CODICE	€
FILTER HONEYCOMB	NO		Nero	222608	9
LENS*	NO	15°	Trasparente	222592	9
LENS*	NO	45°	Trasparente	253558	9
LINK SINGLE CONNECTION	NO		Bianco	170145	23
LINK SINGLE CONNECTION	NO		Nero	170152	23

\*La lente deve essere ordinata contestualmente al prodotto e verrà montata nel prodotto al posto della lente standard inclusa.

# QUICK 21W

PROIETTORI



IP20

MacAdam: SDCM 3

CRI:  $\geq 80 / \geq 90$

DURATA LED: 50.000 h

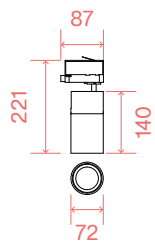

0,760 Kg  
0,0038 m<sup>3</sup>

## LED COB CITIZEN

CRI  $\geq 80$

POTENZA	ANGOLO	LUMEN	CCT	BINARIO	FINITURA	CODICE	€
21 W	30°	2450 lm	3000 K	3-Phase	Bianco	247946	155
21 W	30°	2450 lm	3000 K	3-Phase	Nero	247939	155
21 W	30°	2700 lm	4000 K	3-Phase	Bianco	247960	155
21 W	30°	2700 lm	4000 K	3-Phase	Nero	247953	155

CRI  $\geq 90$

POTENZA	ANGOLO	LUMEN	CCT	BINARIO	FINITURA	CODICE	€
21 W	30°	2000 lm	3000 K	3-Phase	Bianco	247977	155
21 W	30°	2000 lm	3000 K	3-Phase	Nero	225364	155
21 W	30°	2150 lm	4000 K	3-Phase	Bianco	247991	155
21 W	30°	2150 lm	4000 K	3-Phase	Nero	247984	155

	NECESSARIO	ANGOLO	FINITURA	CODICE	€
FILTER HONEYCOMB	NO		Nero	222608	9
LENS*	NO	15°	Trasparente	222592	9
LENS*	NO	45°	Trasparente	253558	9
LINK SINGLE CONNECTION	NO		Bianco	170145	23
LINK SINGLE CONNECTION	NO		Nero	170152	23

\*La lente deve essere ordinata contestualmente al prodotto e verrà montata nel prodotto al posto della lente standard inclusa.

# QUICK 28W

PROIETTORI



MacAdam: SDCM 3 CRI:  $\geq 80$  /  $\geq 90$  DURATA LED: 50.000 h



FOTO p. 330

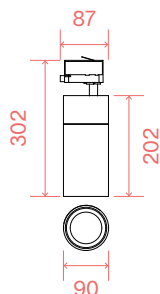

1,200 Kg  
0,0063 m<sup>3</sup>

## LED COB CITIZEN

CRI  $\geq 80$

POTENZA	ANGOLO	LUMEN	CCT	BINARIO	FINITURA	CODICE	€
28 W	30°	3550 lm	3000 K	3-Phase	Bianco	222615	185
28 W	30°	3550 lm	3000 K	3-Phase	Nero	222622	185
28 W	30°	3800 lm	4000 K	3-Phase	Bianco	222639	185
28 W	30°	3800 lm	4000 K	3-Phase	Nero	222646	185

CRI  $\geq 90$

POTENZA	ANGOLO	LUMEN	CCT	BINARIO	FINITURA	CODICE	€
28 W	30°	3100 lm	3000 K	3-Phase	Bianco	222653	185
28 W	30°	3100 lm	3000 K	3-Phase	Nero	222660	185
28 W	30°	3300 lm	4000 K	3-Phase	Bianco	222677	185
28 W	30°	3300 lm	4000 K	3-Phase	Nero	222684	185

	NECESSARIO	ANGOLO	FINITURA	CODICE	€
FILTER HONEYCOMB	NO		Nero	222714	10
LENS*	NO	15°	Trasparente	222691	10
LENS*	NO	45°	Trasparente	222707	10
LINK SINGLE CONNECTION	NO		Bianco	170145	23
LINK SINGLE CONNECTION	NO		Nero	170152	23

\*La lente deve essere ordinata contestualmente al prodotto e verrà montata nel prodotto al posto della lente standard inclusa.

# SPIKE TRACK

PROIETTORI



IP20

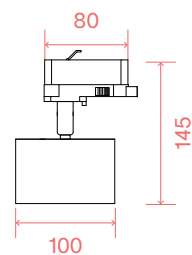

0,370 Kg  
0,0027 m<sup>3</sup>  
GX53 max 1 x 9W

(CONSIGLIATA)

LUMEN	CCT	CODICE	€
910 lm	3000 K	123936	5

FINITURA	CODICE	€
Bianco	344942	60
Nero	336626	60



Lampadine LED GX53 9W  
3000K incluse. Cod. 123936



## STRIP LED SUPPORT

LUNGHEZZA	PESO	VOLUME	FINITURA	CODICE	€
5000 mm	0,06 Kg	0,0029 m <sup>3</sup>	Acciaio	344935	150
5000 mm	0,06 Kg	0,0029 m <sup>3</sup>	Bianco	344928	150
5000 mm	0,06 Kg	0,0029 m <sup>3</sup>	Nero	344911	150

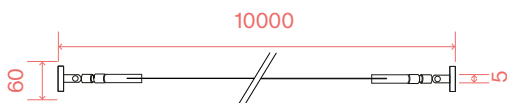

LUNGHEZZA	PESO	VOLUME	FINITURA	CODICE	€
10000 mm	0,08 Kg	0,0029 m <sup>3</sup>	Acciaio	344904	165
10000 mm	0,08 Kg	0,0029 m <sup>3</sup>	Bianco	344898	165
10000 mm	0,08 Kg	0,0029 m <sup>3</sup>	Nero	344881	165



LUNGHEZZA	PESO	VOLUME	FINITURA	CODICE	€
5000 mm	0,35 Kg	0,0234 m <sup>3</sup>	Acciaio	258300	150
5000 mm	0,35 Kg	0,0234 m <sup>3</sup>	Bianco	302256	150
5000 mm	0,35 Kg	0,0234 m <sup>3</sup>	Nero	302263	150



LUNGHEZZA	PESO	VOLUME	FINITURA	CODICE	€
10000 mm	0,45 Kg	0,0029 m <sup>3</sup>	Acciaio	302270	175
10000 mm	0,45 Kg	0,0029 m <sup>3</sup>	Bianco	302287	175
10000 mm	0,45 Kg	0,0029 m <sup>3</sup>	Nero	302294	175

## STRIP LED E DRIVER CONSIGLIATI



STRIP LED (SMD 2835 180 LED/M CRI ≥90 50.000H)

POTENZA	IP	LUMEN	CCT	LUNGHEZZA	CODICE	€
8 W/m	IP20	670 lm/m	2700 K	5x5000 mm	345772	50
8 W/m	IP20	700 lm/m	3000 K	5x5000 mm	345789	50
8 W/m	IP20	750 lm/m	4000 K	5x5000 mm	345796	50

STRIP LED (SMD 2835 120 LED/M CRI ≥90 50.000H)

POTENZA	IP	LUMEN	CCT	LUNGHEZZA	CODICE	€
5 W/m	IP20	470 lm/m	2700 K	8x5000 mm	346328	50
5 W/m	IP20	490 lm/m	3000 K	8x5000 mm	346335	50
5 W/m	IP20	510 lm/m	4000 K	8x5000 mm	346359	50
5 W/m	IP65	460 lm/m	3000 K	8x5000 mm	346342	60
5 W/m	IP65	500 lm/m	4000 K	8x5000 mm	346366	60
10 W/m	IP20	910 lm/m	2700 K	8x5000 mm	346373	50
10 W/m	IP20	940 lm/m	3000 K	8x5000 mm	346380	50
10 W/m	IP20	970 lm/m	4000 K	8x5000 mm	346403	50
10 W/m	IP65	960 lm/m	3000 K	8x5000 mm	346397	60
10 W/m	IP65	1040 lm/m	4000 K	8x5000 mm	346410	60
15 W/m	IP20	1400 lm/m	2700 K	10x5000 mm	272498	55
15 W/m	IP20	1450 lm/m	3000 K	10x5000 mm	272481	55
15 W/m	IP20	1600 lm/m	4000 K	10x5000 mm	272474	55
15 W/m	IP65	1400 lm/m	3000 K	10x5000 mm	272504	75
15 W/m	IP65	1480 lm/m	4000 K	10x5000 mm	287959	75

## DRIVER (ON/OFF)

POTENZA	OUTPUT	LUMEN	CCT	LUNGHEZZA	CODICE	€
30 W	24 Vdc		140 x 28 x 45 mm	255 x 55 x 75 mm	124070	17
60 W	24 Vdc		186 x 33 x 50 mm	255 x 55 x 75 mm	124087	25
150 W	24 Vdc		268 x 31 x 45 mm	330 x 60 x 80 mm	124117	45



# VIRUS

DA INCASSO



IP20 CRI: ≥90 DURATA LED: 50.000 h

↑ FOTO p. 358

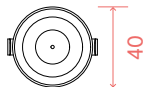
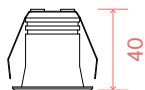

① 30

0,070 Kg  
0,0003 m<sup>3</sup>

LED SMD OSRAM (DRIVER ON/OFF INCLUSO)

POTENZA	ANGOLO	LUMEN	CCT	ESTERNO	FINITURA	CODICE	€
3 W	20°	210 lm	3000 K	Bianco	Bianco	244808	32
3 W	20°	210 lm	3000 K	Bianco	Oro	244822	32
3 W	20°	210 lm	3000 K	Nero	Nero	244846	32
3 W	20°	210 lm	3000 K	Nero	Oro	244853	32

# ZEUS

DA INCASSO



IP20 MacAdam: SDCM 3 UGR: <19 CRI: ≥90 DURATA LED: 50.000 h



↑ FOTO p. 362

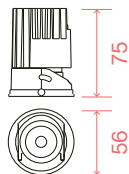

0,300 Kg  
0,0014 m<sup>3</sup>

	NECESSARIO	MODELLO	FINITURA	CODICE	€
LENS 20°	No	13 W	Trasparen.	323688	4
LENS 20°	No	21 W	Trasparen.	323985	6
FILTER HONEYCOMB	No	13 W	Nero	323671	4
FILTER HONEYCOMB	No	21 W	Nero	323961	6

LED COB CITIZEN (NECESSARIO - DRIVER ON/OFF INCLUSO)

POTENZA	ANGOLO	LUMEN	CCT	FINITURA	CODICE	€
13 W	40°	980 lm	2700 K	Grigio	324807	65
13 W	40°	1020 lm	3000 K	Grigio	324814	65
13 W	40°	1050 lm	4000 K	Grigio	324821	65

DIMMABLE DRIVER\* (OPTIONAL)

	POTENZA	OUTPUT	MISURE	CODICE	€
1-10V	21 W	350 mA	122 x 25 x 40 mm	324906	25
DALI / Push	20 W	350 mA	120 x 29 x 51 mm	324913	70

\* Gli alimentatori dimmerabili devono essere ordinati contestualmente al prodotto e verranno già inclusi all'interno degli apparecchi in sostituzione degli alimentatori on-off.

# ZEUS

DA INCASSO



IP20 MacAdam: SDCM 3 UGR: <19 CRI: ≥90 DURATA LED: 50.000 h



↑ FOTO p. 362

## LED COB CITIZEN (NECESSARIO - DRIVER ON/OFF INCLUSO)

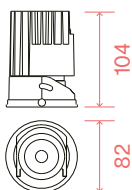

POTENZA	ANGOLO	LUMEN	CCT	FINITURA	CODICE	€
21 W	40°	1900 lm	2700 K	Grigio	324838	105
21 W	40°	2000 lm	3000 K	Grigio	324845	105
21 W	40°	2200 lm	4000 K	Grigio	324852	105

## DIMMABLE DRIVER\* (OPTIONAL)

0,590 Kg  
0,0029 m<sup>3</sup>

	POTENZA	OUTPUT	MISURE	CODICE	€
1-10V	20 W	500 mA	110 x 22 x 52 mm	324920	60
DALI / Push	20 W	500 mA	120 x 29 x 51 mm	324937	70

\* Gli alimentatori dimmerabili devono essere ordinati contestualmente al prodotto e verranno già inclusi all'interno degli apparecchi in sostituzione degli alimentatori on-off.

# ZEUS ROUND

## FRAME AND REFLECTOR

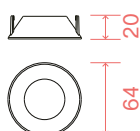

0,030 Kg  
0,0003 m<sup>3</sup>

### REFLECTOR (NECESSARIO)

13 W

FINITURA	CODICE	€
Bianco	323589	8
Nero	323619	8
Oro	323602	8

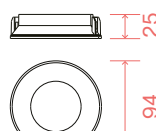

0,040 Kg  
0,0007 m<sup>3</sup>

### REFLECTOR (NECESSARIO)

21 W

FINITURA	CODICE	€
Bianco	323763	12
Nero	323770	12
Oro	323794	12

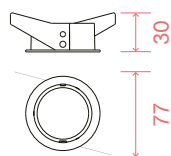

① 70

0,100 Kg  
0,0005 m<sup>3</sup>

### FRAME TRIM (NECESSARIO)

13 W

FINITURA	CODICE	€
Bianco	324869	15
Nero	323527	15

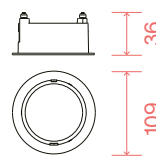

① 100

0,130 Kg  
0,0010 m<sup>3</sup>

### FRAME TRIM (NECESSARIO)

21 W

FINITURA	CODICE	€
Bianco	324883	18
Nero	324005	18

# ZEUS ROUND

## FRAME AND REFLECTOR

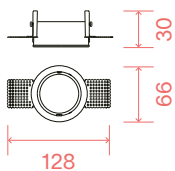

### FRAME TRIMLESS (NECESSARIO)

13 W

FINITURA	CODICE	€
Bianco	323541	18

Ⓜ 73

0,120 Kg  
0,0005 m<sup>3</sup>

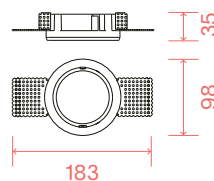

### FRAME TRIMLESS (NECESSARIO)

21 W

FINITURA	CODICE	€
Bianco	323725	35

Ⓜ 105

0,160 Kg  
0,0008 m<sup>3</sup>

# ZEUS SQUARE

## FRAME AND REFLECTOR

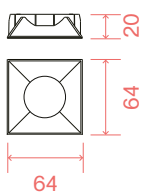

### REFLECTOR (NECESSARIO)

13 W

FINITURA	CODICE	€
Bianco	323633	8
Nero	323657	8
Oro	323640	8

0,030 Kg  
0,0003 m<sup>3</sup>

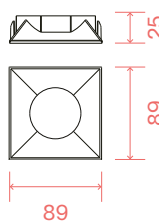

### REFLECTOR (NECESSARIO)

21 W

FINITURA	CODICE	€
Bianco	323800	12
Nero	323817	12
Oro	323831	12

0,050 Kg  
0,0007 m<sup>3</sup>

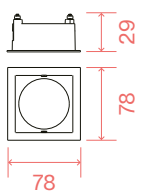

### FRAME TRIM (NECESSARIO)

13 W

FINITURA	CODICE	€
Bianco	324876	15
Nero	323534	15

Ⓜ 68x68

0,100 Kg  
0,0005 m<sup>3</sup>

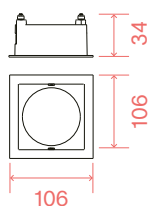

### FRAME TRIM (NECESSARIO)

21 W

FINITURA	CODICE	€
Bianco	324890	18
Nero	323718	18

Ⓜ 96x96

0,130 Kg  
0,0010 m<sup>3</sup>

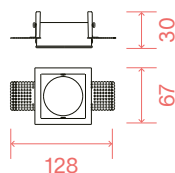

### FRAME TRIMLESS (NECESSARIO)

13 W

FINITURA	CODICE	€
Bianco	323558	18

Ⓜ 68x68

0,120 Kg  
0,0005 m<sup>3</sup>

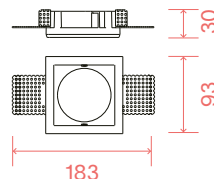

### FRAME TRIMLESS (NECESSARIO)

21 W

FINITURA	CODICE	€
Bianco	323732	35

Ⓜ 96x96

0,160 Kg  
0,0008 m<sup>3</sup>

# AGOS

DA TERRA



IP54



FOTO p. 370

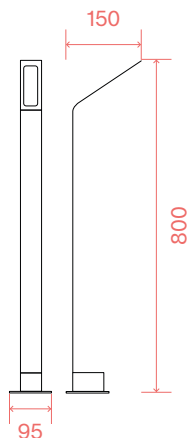

FINITURA	CCT	CODICE	€
Antracite	3000 K	254319	100
Antracite	4000 K	268422	100
Nero	3000 K	326733	100
Nero	4000 K	326757	100
Coffee	3000 K	326726	100
Coffee	4000 K	326740	100



Sorgente luminosa LED  
3000/4000 K, 25.000 h  
di durata.

1,100 Kg  
0,0127 m<sup>3</sup>  
LED 6,5W / 670/730 lm

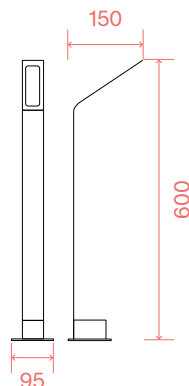

FINITURA	CCT	CODICE	€
Antracite	3000 K	254388	80
Antracite	4000 K	268439	80
Nero	3000 K	326696	80
Nero	4000 K	326719	80
Coffee	3000 K	326689	80
Coffee	4000 K	326702	80



Sorgente luminosa LED  
3000/4000 K, 25.000 h  
di durata.

0,950 Kg  
0,0096 m<sup>3</sup>  
LED 6,5W / 670/730 lm

# ANDROMEDA

DA PARETE



IP55



FOTO p. 378

1,630 Kg  
0,0052 m<sup>3</sup>  
E27 max 2 x 60W



(CONSIGLIATA)

LUMEN	CCT	CODICE	€
580 lm	4000 K	151960	2

FINITURA	CODICE	€
Bianco	100364	85
Grigio	163543	85
Antracite	092355	85
Nero	100371	85
Coffee	163550	85

1,000 Kg  
0,0039 m<sup>3</sup>  
E27 max 1 x 60W

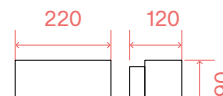

(CONSIGLIATA)

LUMEN	CCT	CODICE	€
580 lm	4000 K	151960	2

FINITURA	CODICE	€
Bianco	066868	55
Grigio	158822	55
Antracite	061580	55
Nero	061597	55
Coffee	163536	55

# ATOM

DA PARETE



IP54



FOTO p. 382

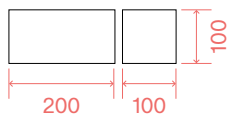

FINITURA	CODICE	€
Bianco	328652	135
Antracite	313412	135
Nero	328676	135
Coffee	328669	135

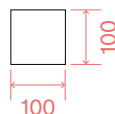

FINITURA	CODICE	€
Bianco	313436	70
Antracite	313429	70
Nero	313450	70
Coffee	313443	70

1,160 Kg  
0,0025 m<sup>3</sup>  
LED 25W / 2100 lm



Sorgente luminosa LED  
3000 K, 30.000 h di durata.

0,660 Kg  
0,0013 m<sup>3</sup>  
LED 12W / 1050 lm



Sorgente luminosa LED  
3000 K, 30.000 h di durata.

# GUN

DA PARETE



IP54



FOTO p. 388



IP44

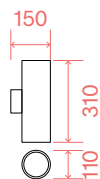

(CONSIGLIATA)

LUMEN	CCT	CODICE	€
580 lm	4000 K	151960	2

FINITURA	CODICE	€
Bianco	092300	72
Alluminio	033020	72
Grigio	163604	72
Antracite	236858	72
Nero	092317	72
Coffee	163611	72

1,350 Kg  
0,0071 m<sup>3</sup>  
E27 max 2 x 60W

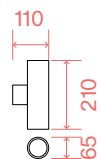

(CONSIGLIATA)

LUMEN	CCT	CODICE	€
430 lm	4000 K	253497	3

FINITURA	CODICE	€
Bianco	100388	65
Alluminio	033013	65
Grigio	163628	65
Antracite	236841	65
Nero	100395	65
Coffee	163635	65

0,720 Kg  
0,0024 m<sup>3</sup>  
GU10 max 2 x 35W

DA SOFFITTO



IP44

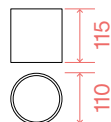

(CONSIGLIATA)

LUMEN	CCT	CODICE	€
430 lm	4000 K	253497	3

FINITURA	CODICE	€
Bianco	122663	54
Alluminio	092324	54
Grigio	163642	54
Antracite	236865	54
Nero	122687	54
Coffee	163666	54

0,490 Kg  
0,0030 m<sup>3</sup>  
GU10 max 1 x 28W

# JEDI

DA TERRA



IP65



FOTO p. 396

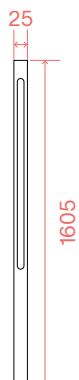

1,280 Kg  
0,0065 m<sup>3</sup>  
LED 25W / 2600 lm

FINITURA	CODICE	€
Antracite	306803	155
Nero	293202	155

Sorgente luminosa LED  
3000 K, 30.000 h di durata.

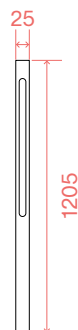

1,030 Kg  
0,0050 m<sup>3</sup>  
LED 19W / 2050 lm

FINITURA	CODICE	€
Antracite	306797	125
Nero	293196	125

Sorgente luminosa LED  
3000 K, 30.000 h di durata.



Base  
Non incluso  
Optional

FINITURA	CODICE	€
Antracite	308227	13
Nero	308234	13

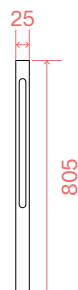

0,760 Kg  
0,0036 m<sup>3</sup>  
LED 12W / 1250 lm

FINITURA	CODICE	€
Antracite	306780	90
Nero	293189	90

Sorgente luminosa LED  
3000 K, 30.000 h di durata.

# LINEA

DA PARETE / SOFFITTO



IP54



FOTO p. 402

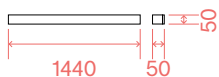

1,750 Kg  
0,0049 m<sup>3</sup>  
LED 23W / 2400 lm

FINITURA	CODICE	€
Bianco	328584	185
Antracite	313504	185
Nero	328607	185
Coffee	328591	185

Sorgente luminosa LED  
3000 K, 30.000 h di durata.

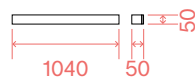

1,430 Kg  
0,0036 m<sup>3</sup>  
LED 20W / 1950 lm

FINITURA	CODICE	€
Bianco	313474	145
Antracite	313467	145
Nero	313498	145
Coffee	313481	145

Sorgente luminosa LED  
3000 K, 30.000 h di durata.

# LOLITA

DA TAVOLO



IP54



FOTO p. 406

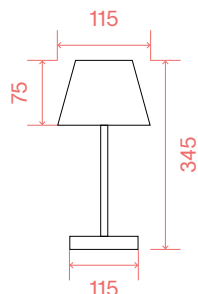

FINITURA	CODICE	€
Bianco	286723	55
Grigio	286730	55
Nero	286716	55
Coffee	286747	55

Sorgente luminosa LED  
3000 K, 25.000 h di durata.

Durata 14 ore.



0,550 Kg  
0,0078 m<sup>3</sup>  
LED 1,8W / 150 lm

# PUNTO

DA PARETE / SOFFITTO



IP54



FOTO p. 414

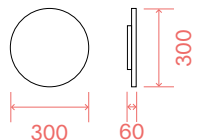

FINITURA	CODICE	€
Bianco	328553	150
Antracite	313566	150
Nero	328577	150
Coffee	328560	150

Sorgente luminosa LED  
3000 K, 30.000 h di durata.

2,090 Kg  
0,0135 m<sup>3</sup>  
LED 16W / 1750 lm

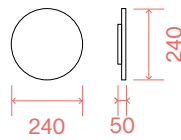

FINITURA	CODICE	€
Bianco	328522	125
Antracite	313559	125
Nero	328546	125
Coffee	328539	125

1,280 Kg  
0,0083 m<sup>3</sup>  
LED 12W / 1250 lm

Sorgente luminosa LED  
3000 K, 30.000 h di durata.

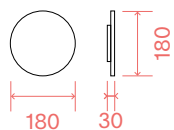

FINITURA	CODICE	€
Bianco	313528	65
Antracite	313511	65
Nero	313542	65
Coffee	313535	65

Sorgente luminosa LED  
3000 K, 30.000 h di durata.

0,820 Kg  
0,0018 m<sup>3</sup>  
LED 9W / 950 lm

# PURE

DA TERRA



IP54



FOTO p. 418

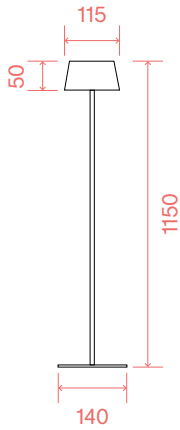

1,580 Kg  
0,0058 m<sup>3</sup>  
LED 1,5W / 230 lm

FINITURA	CODICE	€
Bianco	311708	115
Nero	328515	115
Coffee	328508	115

Sorgente luminosa LED  
3000 K, 30.000 h di durata.

Durata 7 ore.



DA TAVOLO



IP54

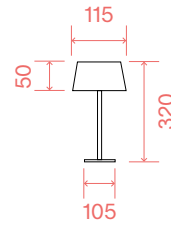

0,840 Kg  
0,0052 m<sup>3</sup>  
LED 1,5W / 230 lm

FINITURA	CODICE	€
Bianco	311685	85
Nero	311678	85
Coffee	311661	85

Sorgente luminosa LED  
3000 K, 30.000 h di durata.

Durata 7 ore.



# SIRIO

DA TERRA



IP44



FOTO p. 422

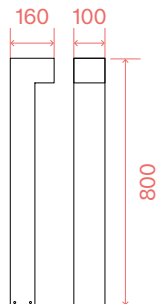

1,880 Kg  
0,0181 m<sup>3</sup>  
G9 max 2 x 15W

(CONSIGLIATA)

LUMEN	CCT	CODICE	€
530 lm	4000 K	307879	6

FINITURA	CODICE	€
Bianco	115085	180
Grigio	246963	180
Antracite	115061	180
Nero	115108	180
Coffee	213262	180

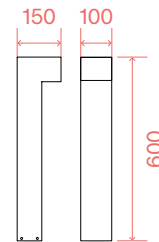

1,550 Kg  
0,0136 m<sup>3</sup>  
G9 max 2 x 15W

(CONSIGLIATA)

LUMEN	CCT	CODICE	€
530 lm	4000 K	307879	6

FINITURA	CODICE	€
Bianco	115092	145
Grigio	246970	145
Antracite	115078	145
Nero	115115	145
Coffee	213279	145



# SIRIO

DA PARETE



IP65

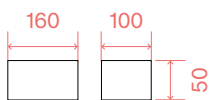

(CONSIGLIATA)

LUMEN	CCT	CODICE	€
1000 lm	4000K	154008	5

FINITURA	CODICE	€
Bianco	318226	90
Grigio	345611	90
Antracite	318202	90
Nero	318219	90
Coffee	318196	90

0,820 Kg  
0,0018 m<sup>3</sup>  
GX53 max 1 x 9W

PROIETTORE



IP65

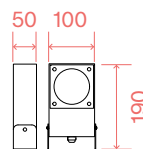

(CONSIGLIATA)

LUMEN	CCT	CODICE	€
1000 lm	4000K	154008	5

FINITURA	CODICE	€
Bianco	345628	110
Grigio	345642	110
Antracite	318233	110
Nero	345659	110
Coffee	345635	110

1,070 Kg  
0,0021 m<sup>3</sup>  
GX53 max 1 x 9W

# SOLE

SOSPENSIONE



IP44

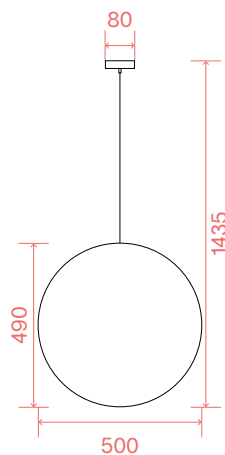

(CONSIGLIATA)

LUMEN	CCT	CODICE	€
1020 lm	4000 K	151991	2

FINITURA	CODICE	€
Bianco	136011	180

2,970 Kg  
0,1327 m<sup>3</sup>  
E27 max 1 x 42W

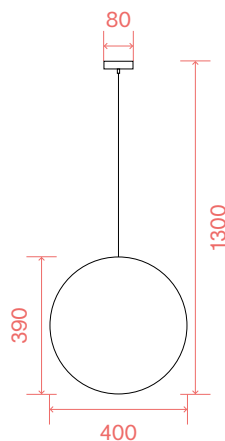

(CONSIGLIATA)

LUMEN	CCT	CODICE	€
1020 lm	4000 K	151991	2

FINITURA	CODICE	€
Bianco	136004	110

1,690 Kg  
0,0776 m<sup>3</sup>  
E27 max 1 x 42W

# SOLE

## SOSPENSIONE



IP44

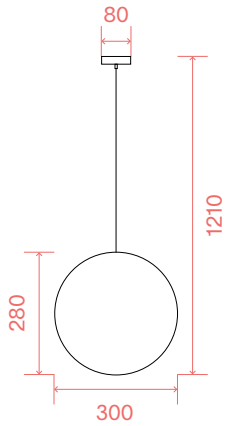

(CONSIGLIATA)

LUMEN	CCT	CODICE	€
1020 lm	4000 K	151991	2
FINITURA		CODICE	€
Bianco		135991	95

1,360 Kg  
0,0338 m<sup>3</sup>  
E27 max 1 x 42W

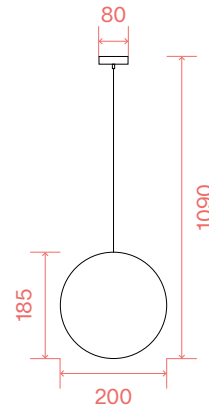

(CONSIGLIATA)

LUMEN	CCT	CODICE	€
580 lm	4000 K	151960	2
FINITURA		CODICE	€
Bianco		318837	90

1,300 Kg  
0,0111 m<sup>3</sup>  
E27 max 1 x 42W

## DA TERRA



IP44



FOTO p. 430

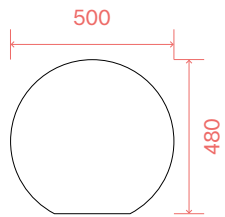

(CONSIGLIATA)

LUMEN	CCT	CODICE	€
1020 lm	4000 K	151991	2
FINITURA		CODICE	€
Bianco		191614	225

4,500 Kg  
0,1460 m<sup>3</sup>  
E27 max 1 x 42W

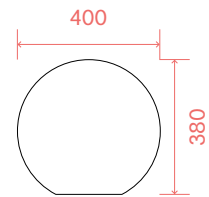

(CONSIGLIATA)

LUMEN	CCT	CODICE	€
1020 lm	4000 K	151991	2
FINITURA		CODICE	€
Bianco		191621	150

3,900 Kg  
0,0741 m<sup>3</sup>  
E27 max 1 x 42W

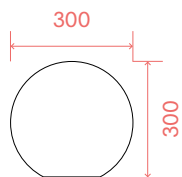

(CONSIGLIATA)

LUMEN	CCT	CODICE	€
1020 lm	4000 K	151991	2
FINITURA		CODICE	€
Bianco		191638	120

2,700 Kg  
0,0322 m<sup>3</sup>  
E27 max 1 x 42W

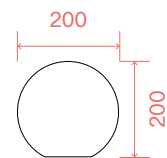

(CONSIGLIATA)

LUMEN	CCT	CODICE	€
580 lm	4000 K	151960	2
FINITURA		CODICE	€
Bianco		318820	110

1,200 Kg  
0,0139 m<sup>3</sup>  
E27 max 1 x 42W

# STARLIGHT

PROIETTORE



MacAdam: SDCM 3 IP68 CRI: ≥90 DURATA LED: 50.000 h



FOTO p. 436

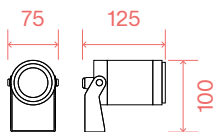

## LED COB BRIDGELUX (DRIVER NON INCLUSO)

POTENZA	ANGOLO	LUMEN	CCT	FINITURA	CODICE	€
10 W	30°	930 lm	3000 K	Grigio Scuro	248387	250
10 W	30°	1000 lm	4000 K	Grigio Scuro	245072	250

0,950 Kg  
0,0014 m<sup>3</sup>

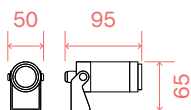

## LED COB CITIZEN / BRIDGELUX (DRIVER NON INCLUSO)

POTENZA	ANGOLO	LUMEN	CCT	FINITURA	CODICE	€
5,5 W	30°	500 lm	3000 K	Grigio Scuro	248394	120
5,5 W	30°	600 lm	4000 K	Grigio Scuro	245041	120

0,280 Kg  
0,0005 m<sup>3</sup>

## OPTIONAL (NON INCLUSO)

	POTENZA	FINITURA	CODICE	€
Visiera	5,5 W	Grigio Scuro	245096	34
Visiera	10 W	Grigio Scuro	245102	34
Picchetto		Grigio Scuro	245089	17

## ON/OFF DRIVER (NON INCLUSO/NECESSARIO)

OUTPUT	POTENZA	MISURA	CODICE	€
24 Vdc	20 W	118 x 26 x 35 mm	226187	75
24 Vdc	40 W	148 x 30 x 40 mm	226194	80
24 Vdc	100 W	220 x 39 x 68 mm	226200	190
24 Vdc	185 W	220 x 39 x 68 mm	226217	210

# STYLE

DA PARETE

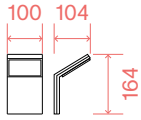

0,390 Kg  
0,0018 m<sup>3</sup>  
LED 8,5W  
950/1050 lm

FINITURA	CCT	CODICE	€
Bianco	3000 K	269139	135
Bianco	4000 K	221502	135
Grigio	3000 K	322650	135
Grigio	4000 K	322643	135
Antracite	3000 K	246857	135
Antracite	4000 K	209845	135
Nero	3000 K	322636	135
Nero	4000 K	322629	135
Coffee	3000 K	322704	135
Coffee	4000 K	322681	135

Sorgente luminosa LED  
3000/4000 K, 30.000 h  
di durata.

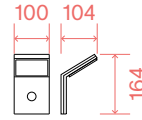

0,400 Kg  
0,0018 m<sup>3</sup>  
LED 9W  
950/1050 lm

FINITURA	CCT	CODICE	€
Bianco	3000 K	269146	165
Bianco	4000 K	209852	165
Antracite	3000 K	246864	165
Antracite	4000 K	221519	165

Sorgente luminosa LED  
3000/4000 K, 30.000 h  
di durata.



DA TERRA



FOTO p. 442

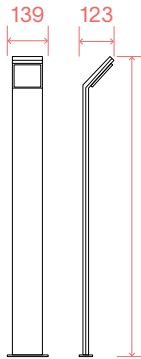

1,680 Kg  
0,0239 m<sup>3</sup>  
LED 8,5W  
950/1050 lm

FINITURA	CCT	CODICE	€
Bianco	3000 K	318707	190
Bianco	4000 K	322483	190
Grigio	3000 K	322384	190
Grigio	4000 K	322353	190
Antracite	3000 K	246871	190
Antracite	4000 K	209906	190
Nero	3000 K	322230	190
Nero	4000 K	322216	190
Coffee	3000 K	322452	190
Coffee	4000 K	322438	190

Sorgente luminosa LED  
3000/4000 K, 30.000 h  
di durata.

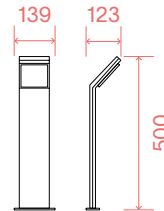

1,020 Kg  
0,0122 m<sup>3</sup>  
LED 8,5W  
950/1050 lm

FINITURA	CCT	CODICE	€
Bianco	3000 K	318691	145
Bianco	4000 K	322582	145
Grigio	3000 K	322551	145
Grigio	4000 K	322544	145
Antracite	3000 K	322612	145
Antracite	4000 K	322599	145
Nero	3000 K	322537	145
Nero	4000 K	322506	145
Coffee	3000 K	322575	145
Coffee	4000 K	322568	145

Sorgente luminosa LED  
3000/4000 K, 30.000 h  
di durata.

# SWIPE

DA PARETE



IP54



FOTO p. 448

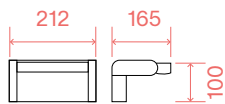

1,200 Kg  
0,0055 m<sup>3</sup>  
LED 20,5W / 2300 lm

FINITURA	CODICE	€
Bianco	287690	120
Grigio	326863	120
Antracite	287683	120
Nero	287706	120
Coffee	307169	120



Sorgente luminosa LED  
3000 K, 50.000 h di durata.

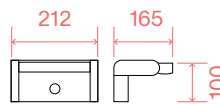

1,300 Kg  
0,0055 m<sup>3</sup>  
LED 21W / 2300 lm

FINITURA	CODICE	€
Bianco	287720	130
Grigio	326870	130
Antracite	287713	130
Nero	287737	130
Coffee	307176	130



Sorgente luminosa LED  
3000 K, 50.000 h di durata.



# TAURUS ACCENT

DA INCASSO



IP67 CRI: ≥90 DURATA LED: 50.000 h



↑ FOTO p. 454

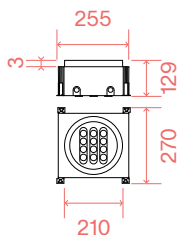

3,500 Kg  
0,0242 m<sup>3</sup>

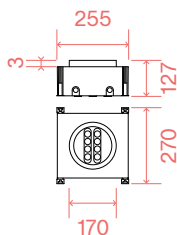

3,250 Kg  
0,0133 m<sup>3</sup>

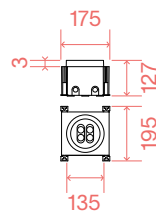

1,980 Kg  
0,0071 m<sup>3</sup>

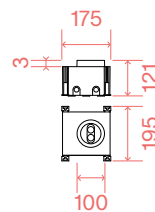

1,460 Kg  
0,0129 m<sup>3</sup>

LED SMD OSRAM (DRIVER ON/OFF INCLUSO)

DIMENSIONI	POTENZA	LUMEN	CCT	FINITURA	CODICE	€
ø 210	20 W	1800 lm	3000 K	Acciaio	277035	530
ø 170	12 W	1200 lm	3000 K	Acciaio	277028	405
ø 135	11 W	790 lm	3000 K	Acciaio	277011	320
ø 100	6 W	400 lm	3000 K	Acciaio	277004	210

# TECHO

DA SOFFITTO

↑ IP54    ↑ FOTO p. 460

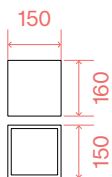

1,700 Kg  
0,0049 m<sup>3</sup>  
GU10 max 1 x 20W

(CONSIGLIATA)

LUMEN	CCT	CODICE	€
780 lm	4000 K	253398	15

FINITURA	CODICE	€
Bianco	251523	115
Grigio	326887	115
Antracite	251516	115
Nero	251530	115
Coffee	251547	115

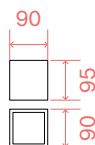

0,600 Kg  
0,0012 m<sup>3</sup>  
GU10 max 1 x 20W

(CONSIGLIATA)

LUMEN	CCT	CODICE	€
430 lm	4000 K	253497	3

FINITURA	CODICE	€
Bianco	251561	64
Grigio	326894	64
Antracite	251554	64
Nero	251578	64
Coffee	251592	64

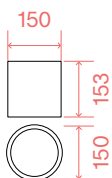

1,500 Kg  
0,0052 m<sup>3</sup>  
GU10 max 1 x 20W

(CONSIGLIATA)

LUMEN	CCT	CODICE	€
780 lm	4000 K	253398	15

FINITURA	CODICE	€
Bianco	342689	115
Grigio	342702	115
Antracite	318103	115
Nero	342719	115
Coffee	342696	115

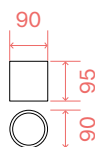

0,550 Kg  
0,0015 m<sup>3</sup>  
GU10 max 1 x 20W

(CONSIGLIATA)

LUMEN	CCT	CODICE	€
430 lm	4000 K	253497	3

FINITURA	CODICE	€
Bianco	318127	64
Grigio	342726	64
Antracite	318110	64
Nero	318141	64
Coffee	318134	64

# TESLA

DA TERRA



IP44



FOTO p. 466

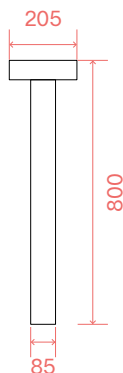

(CONSIGLIATA)

LUMEN	CCT	CODICE	€
530 lm	4000 K	307879	6

FINITURA	CODICE	€
Bianco	153179	155
Antracite	153162	155
Nero	316055	155
Coffee	326924	155

3,000 Kg  
0,0379 m<sup>3</sup>  
G9 max 4 x 15W

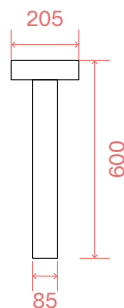

(CONSIGLIATA)

LUMEN	CCT	CODICE	€
530 lm	4000 K	307879	6

FINITURA	CODICE	€
Bianco	153209	145
Antracite	153193	145
Nero	326917	145
Coffee	316048	145

2,560 Kg  
0,0273 m<sup>3</sup>  
G9 max 4 x 15W

# VEGA

DA TERRA



IP44



FOTO p. 472

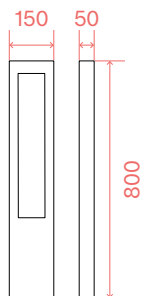

(CONSIGLIATA)

LUMEN	CCT	CODICE	€
530 lm	4000 K	307879	6

FINITURA	CODICE	€
Bianco	136035	180
Grigio	136042	180
Antracite	136028	180
Nero	136059	180
Coffee	213361	180

1,150 Kg  
0,0092 m<sup>3</sup>  
G9 max 1 x 15W



## Icone tecniche



Classe I Sicurezza elettrica garantita dall'isolamento principale e da un conduttore di protezione (messa a terra) collegato alla struttura metallica della lampada. Messa a terra obbligatoria.



Classe III Sicurezza elettrica garantita dall'alimentazione a bassissima tensione (inferiore a 50 Volt). Non deve avere messa a terra.



Classe II Sicurezza elettrica garantita dall'isolamento principale e da un doppio isolamento o da un isolamento rinforzato. Non deve avere messa a terra.



Marchio di conformità alle direttive comunitarie europee di sicurezza.

## Simboli



Articoli con lampade a LED: consumo estremamente ridotto, luce chiara e concentrata, robustezza e lunga durata.



Apparecchio fornito con variatore di potenza.



Interruttore integrato nel corpo luce.



Lampada con presa USB integrata.



Apparecchio dotato di interruttore touch: si accende e si regola l'intensità col tocco di un dito sul corpo luce.



Lampada con batteria ricaricabile inclusa.



Lampada con rilevazione di presenza inclusa PIR (Passive InfraRed).



Articolo in acciaio inox 316.



Prodotto ad alto contenuto tecnologico, elevata qualità dei materiali, destinato ad uso professionale.

### NOTE:

#### - I prezzi indicati sono riferiti al pubblico IVA esclusa.

- Ideal lux s.r.l. si riserva il diritto di apportare, in qualunque momento e senza preavviso, tutte le modifiche necessarie a migliorare la qualità degli articoli illustrati nel presente catalogo. Per verificare le caratteristiche più aggiornate, consultare la documentazione nel sito web ([www.ideal-lux.com](http://www.ideal-lux.com)).

- I nostri prodotti in classe I e II si alimentano con tensione nominale di 220-240 vac 50/60 hz. Tutti i nostri prodotti sono conformi alle direttive CE.

- Qualora acquistato separatamente come "optional", il driver dimmerabile sarà già incluso nel prodotto in sostituzione del driver standard on-off: verrà fornito un solo driver.

- I Watt indicati a catalogo esprimono la potenza NOMINALE dell'articolo comprensivo di sorgente

e driver, quando inclusi. I valori riferiti ai lm relativi alle lampade con sorgenti integrate a LED, sono da considerarsi NOMINALI, riferiti cioè alla sorgente. Per i lm effettivi dei singoli apparecchi illuminanti si prega gentilmente di consultare le fotometrie.

- Il valore UGR non è una caratteristica dell'apparecchio, ma dell'installazione. Gli UGR riportati in questo catalogo sono stati calcolati tenendo conto di un'installazione ideale e sono raggruppati nei blocchi <10 <13 <16 <19 <22.

Si consiglia di calcolare l'UGR specifico secondo la propria installazione.

- La durata di vita utile delle sorgenti LED di tutti gli articoli presenti a catalogo è riferita al valore L70B50, quando non dichiarato altrimenti.





Agos, Andromeda, Atom, Bean, Binomio, Birds, Clip, Cover, Delta, Deva, Diesis, Display, Dorsale, Dynamite, Ego, Eos, Equinoxe, Essence, Filo, Fluo, Fly, Focus, Fox, Frame, Futura, Game, Gemini, Gun, Jedi, Lika, Linea, Link, Linus, Lolita, Look, Mapa, Mint, Mix Up, Moby, Nemo, Ninfea, Nitro, Nova, Oracle Slim, Oz, Perlage, Piano, Punto, Pure, Quick, Set Up, Sirio, Smarties, Sole, Spike, Starlight, Style, Swipe, Taurus, Techo, Tesi, Tesla, Ultrathin, Vega, Virus, Zeus, Zig Zag.